

6-1-2021

Effect of Fuel-Air Mixture Motion on the Working parameters of Spark ignition Engines.

M. Abu El-Enin

Assistant Professor of I.C.E. , Faculty of Engineering and Technology Port-Said.

Follow this and additional works at: <https://mej.researchcommons.org/home>

Recommended Citation

Abu El-Enin, M. (2021) "Effect of Fuel-Air Mixture Motion on the Working parameters of Spark ignition Engines.," *Mansoura Engineering Journal*: Vol. 10 : Iss. 1 , Article 10.

Available at: <https://doi.org/10.21608/bfemu.2021.176999>

This Original Study is brought to you for free and open access by Mansoura Engineering Journal. It has been accepted for inclusion in Mansoura Engineering Journal by an authorized editor of Mansoura Engineering Journal. For more information, please contact mej@mans.edu.eg.

EFFECT OF FUEL- AIR MIXTURE MOTION
ON THE WORKING PARAMETERS OF
SPARK IGNITION ENGINES.

§
Dr. Eng. M. A. Abu El-Enin.

ABSTRACT ;

The object of this work was to learn more about the effect of fuel-air mixture upon the performance of spark ignition engines, and to determine how variations in mixture velocity after leaving engine carburetor alter the combustion process. To provide effective means for producing and measuring the mixture velocity, all tests were made in a multi-cylinder spark-ignition engine using a blade swirler. The effect of mixture motion on the volumetric efficiency, rate of pressure rise, brake thermal efficiency, and mixture distribution were determined for wide range of engine speeds and loads. The results reveal that a mixture motion improve the mixture quality and quantity of the engine cylinders, this effect gives evenly gas pressure cycles. The engine brake thermal efficiency depend upon the type of swirler motion.

NOMENCLATURE;

B. - - - - - Brake horse power.
b.s.f.c. --- brake specific fuel consumption (kg/Hp.hr)
M --- Rate of mass flow. (kg/hr)
N - - - - - Speed. r.p.m.
Me - - - - - Force. Newton.
P --- Pressure. kg/cm²
(R.P.R.).. Maximum rate of pressure rise. kg/cm²C.A.D.
t --- Temperature c°
Δ Increasement
η Efficiency
θ Swirl angle
λ Excess air factor
φ Crank angle degree.

Subscript.

A.....Air
As.....After swirler
F.....Fuel
thb.....Thermal brake
V.....Volume

INTRODUCTION;

The fuel spray after leaving the carburetor consist of partly evaporated fuel, amist of fine particles, and considerable amount of heavier of fuel. The fuel spray becomes coarser and the heavier particles increase as the suction head and air velocity at the jet are decreased.

§ Lecturer of I.C.E.

Faculty of Engineering and Technology Port-Said.

The condition of mixture at the cylinder inlet ports depends upon the heat transferred between the carburetor and the ports, velocity of the flow and the design of the intake manifold. It is extremely difficult in a multi-cylinder engine to maintain fuel-air ratio constant between the various cylinders throughout the range of speed and load. Also, a manifold that provides air distribution does not necessarily provide fuel distribution, particularly when the mixture contain particles.

However, there are irregularities in distribution that are due to variation in quantity and quality (fuel-air ratio), both from cylinder to cylinder and cycle to cycle of the same cylinder.

Variations in quantity and quality of the mixture effect the engine performance and running (1,2). Also, the mixture that contains unvaporised fuel increases the wear of cylinder walls and piston surface (2). The variation of the pressure from cycle to cycle of the same cylinder is recognized to be due to the variation of the mixture strength (3).

Donahue et al (4), and Ma (5) studied the effect of mixture velocity in the manifold on the fuel distribution. Bolt et al (6), studied the effect of the mixture motion upon the lean limit and combustion process of constant volume combustion chamber.

The objective of this work is to determine the effect of mixture swirl motion in the engine manifold on the combustion processes and working parameters of spark ignition engine. All tests were conducted with the aid of a swirler with various angles, which is located between the carburetor and suction manifold.

APPARATUS AND GENERAL EXPERIMENTAL PROCEDURE;

The experimental tests were carried out on a four stroke spark ignition engine, with the following specifications,

- Model no. : 2364 E Ford.
- Type : 4cylinder inline with direct flow head,
- Bore /stroke: 80.98/77.62 mm.,
- Compression ratio: 9:1,
- Carburetor type : 1 V M A N C (down draft),
- Inlet manifold type : separate ports each cylinder,

The test rig is prepared by G. Cussons ltd. with the following instrumentation :

- a) Heenan Froude dynamometer to measure the engine torque.
- b) Fuel flow meter to measure the volumetric rate of fuel consumption.
- c) Electronic tachometer to measure the average engine speed.
- d) Viscous flow air meter to measure air flow.
- e) Multi point pyrometer to measure exhaust gas temperatures at 5 points.
- f) Cooling water flow meter.

Also, the engine was prepared with the necessary transducers (gas pressure transducer located on the cylinder No.4- synchronizing transducer - top dead center transducer and crank angle transducer). All these transducers were connected with 4 beam oscilloscope for using with channel analysis system prepared with universal camera.

Fig.(1) show the typical recorded (P- ϕ) diagram taken during the experimental on the oscilloscope screen.

Calibrated curve for pressure transducer and oscilloscope magnitude are given by the firm.

Samples of exhaust gas were piped out of the exhaust manifold as near as possible from the exhaust valve exit of each cylinder and from the main exhaust manifold. Exhaust gas samples were analyzed by an Orsat apparatus (type Bacharak) to determine carbon dioxide and oxygen percentage in the exhaust.

A swirler was erected to change the angle of mixture flow. Fig.(2) show the design of swirler; the net area of the swirler was designed to be of the same cross sectional area of the induction manifold, to eliminate the effect of throttling. Tests were carried out at 20, 30 and 40 swirl angle.

Temperatures of the mixture at outlet of swirler were measured by a mercury thermometer.

The general layout of the experimental rig is shown in fig.(3) ; while fig.(4) shows the photo of experimental rig.

A series of tests were made covering a range of speeds, loads and swirler angle (θ). Ranges of speeds concerned in tests are 1500, 1800, 2100 and 2400 r.p.m., for swirler angles (zero, 20, 30, and 40) at different engine loads. A sample of tests reading is given in table(1).

From the data obtained by measuring instruments, the interest quantities can be calculated by aid at all correction factors provided by manufactured firm. Also, the maximum pressure rise rate (P.R.P) obtained by photographing the cyclic trace on the oscilloscope screen by a universal camera. Full correction charts are provided to know the traces magnitude. Table II. shows samples of tests results.

-EXPERIMENTAL RESULTS AND DISCUSSION.

To study the effect of swirler on the engine working parameters, a different tests were carried out without using the swirler ($\theta=0$) at different loads and speeds as given in table(1). The same tests were conducted at different swirlers ($\theta=20$, $\theta=30$, and $\theta=40$) considering the engine load, speed, spark timing are constant. The results of tests can be studied as follow.

1- Effect Of Swirler On mixture Distribution.

In order to study the effect of swirler on the qualitative mixture distribution; a sample of combustion gases in each cylinder is drawn from exhaust gas manifold near the exhaust gas valve of each cylinder by a (3mm.) stainless tube. The samples were analyzed by the Orsat Bachark apparatus. Fig.(5) shows a sample of these results as a function of speed and load for various swirler angles. The effect of swirlers on mixture qualitative of this type of manifold for all tests group are similar to these of fig.(5). It shows all types of swirler are proving the mixture quality of cylinder. Increasing the swirler angle up ($\theta=30$) tend to have a constant mixture quality even with engine varying speeds or load.

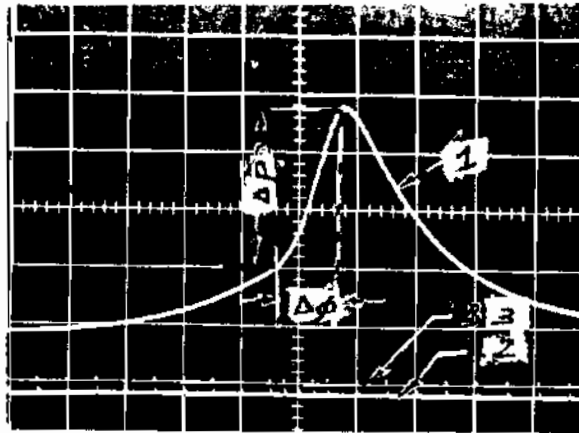

Fig (1). A typical (P- ψ) diagram.

1- Gas pressure trace. 2- Crank angle trace. 3- Top dead center.

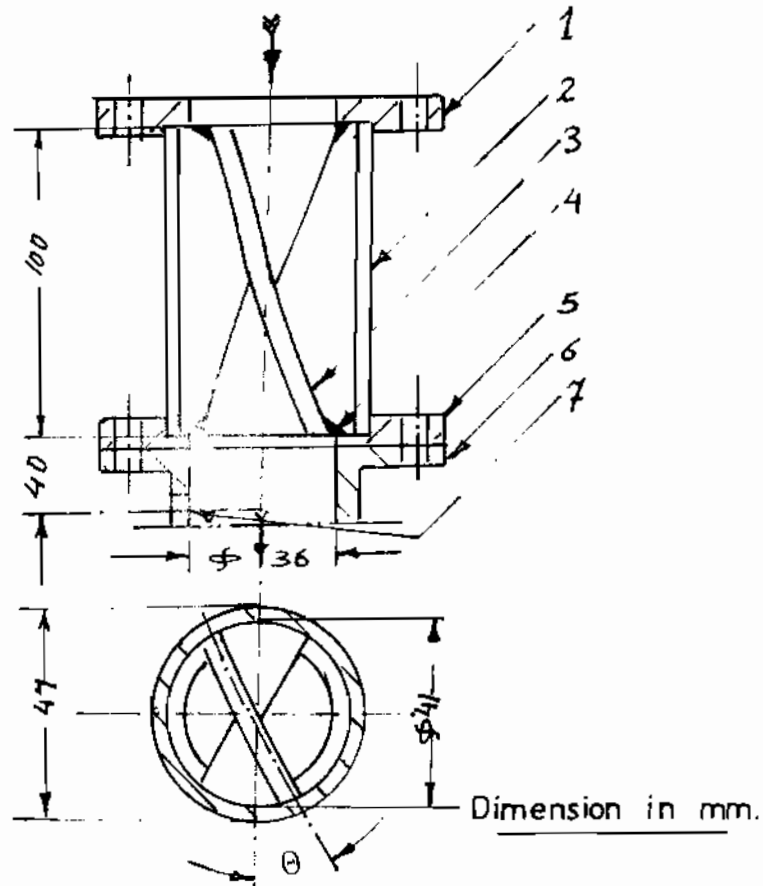

Fig.(2). Construction of swirler type.

1- Flangh side carburetor. 2- Swirler pipe. 3- Swirler.
 4- Adhesive. 5- Manifold flangh. 6- Inlet manifold.
 7 - Thermometer position.

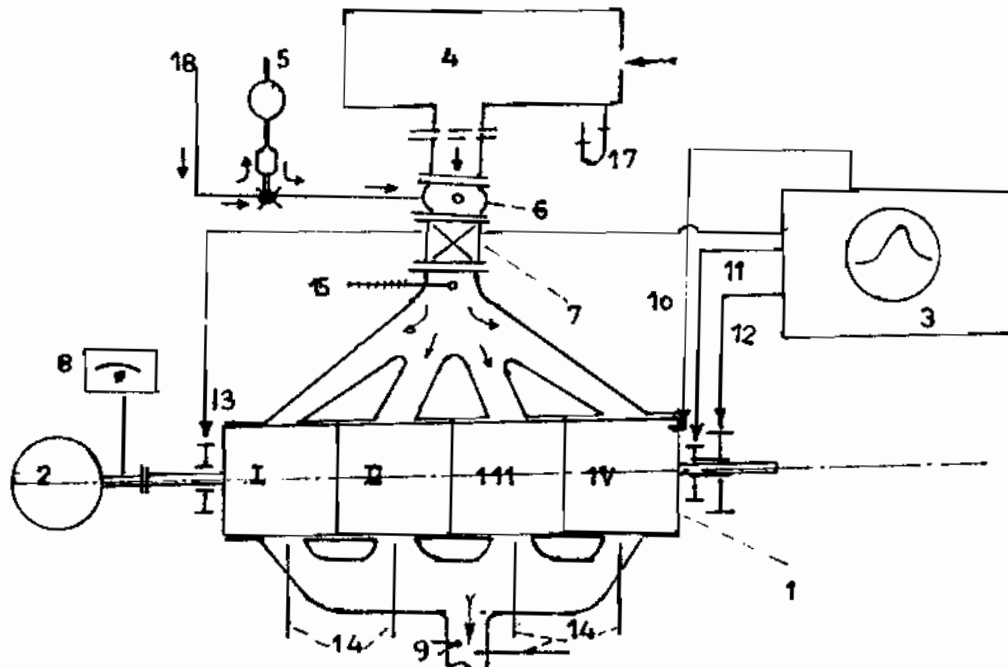

Fig.(3) General Layout of Experimental Rig.

- 1) Engine. 2) Dynamometer. 3) Oscilloscope. 4) Airbox. 5) Fuelmeter.
 6) Carburettor. 7) Swirler. 8) Tachometer. 9) Exhaust thermocouple.
 10, 11, 12, 13) Transducers. 14) Exhaust gas probes. 15) Thermometer.
 16) Camera. 17) Manometer. 18) Main fuel.

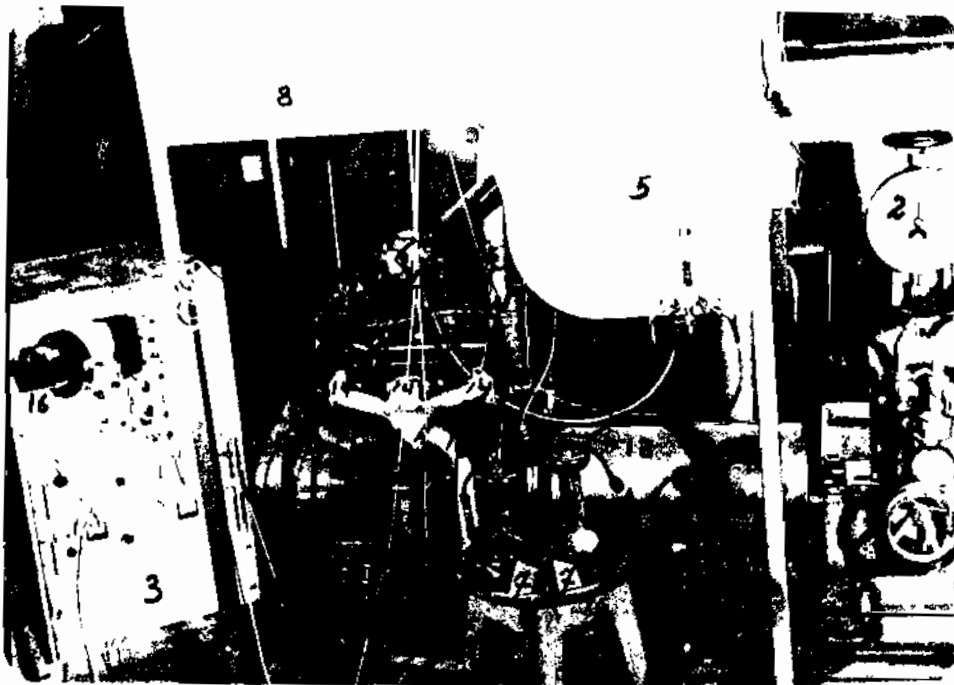

Fig.(4) Photo of Experimental Rig

Table (I). Sample of Test Readings

Test no.	Speed RPM	Load Ne.	Time of 50-cm ³ fuel sec.	Air cons.		Cooling water		Engine		Cyl. I		Cyl. II		Cyl. III		Cyl. IV.		Film frame NO.	Remarks						
				dP cm H ₂ O	t. %	M _A Kg/hr	ΔP cm. H ₂ O	CO ₂ %	O ₂ %	t _{ex} C°	t _{A.S} C°	CO ₂ %	O ₂ %	*load 2.3.4 N.	CO ₂ %	O ₂ %	*load 1.2.4 N.			CO ₂ %	O ₂ %	*load 1.2.3 N.			
1	1500	5.5	80	1.25	23	2.15	55	14	4	590	21	13.5	4.5	3.7	14.3	3.1	3.5	13.8	2.9	3.5	13.4	3.8	3.7	I 6,7,8	
2	1500	13.5	71	1.75	23	2.25	56	14.5	3	560	21	14	3.5	8.1	14.6	2.4	7.95	14.4	2.8	8	14.1	2.9	8.15	I 23,24	
3	1500	22.5	57	2.55	23	2.35	56	14	2.5	585	21	13.8	4.2	15.5	14	4	15	14.1	3.8	15	13.9	4.1	15.5	II 2,3	θ=0 * = Morse test.
4	1500	30	39	4	23	3	57	14	4	710	21	14	4	22	14	4	21	14	4	21	14	4	22	II 4,5	
5	1500	34	35	4.25	23	3.35	57	14.5	3	660	21	14	2	25	14.5	1	24.5	14.5	1.5	24	14	2	25	II 6,7	

Table (II). Sample of Test Results

Test no.	Speed RPM	B. Load HP	M _F Kg/hr	M _A Kg/hr	M _F Kg/hr	M _A Kg/hr	γ _v %	b.s.f.c. (R.P.R) atm/CAD	Excess Air Factor [λ]			Rem.		
									Engine	Cyl. I	Cyl. II		Cyl. III	Cyl. IV
1	1500	1.175	2	34.9	36.9	32	1.702	0.5	1.172	1.250	1.160	1.140	1.208	
2	1500	2.880	2.60	48.3	51.9	45	0.902	1	1.280	1.187	1.120	1.140	1.150	
3	1500	4.760	3.20	63.75	66.95	58	0.672	1.5	1.370	1.230	1.200	1.180	1.240	
4	1500	5.768	3.75	68.98	72.72	63	0.65	1.7	1.260	1.230	1.230	1.230	1.230	
5	1500	7.260	4	74.5	78.5	68	0.55	2	1.280	1.090	1.040	1.060	1.090	

M. 12 M.A. ABU EL-ENIN

Table III

The variation of mixture quality in Cylinder IV and mixture temperature after swirler.

Test NO.	Speed R.P.M.	Load HP	$\theta = \text{Zero}$		$\theta = 20^\circ$		$\theta = 30^\circ$		$\theta = 40^\circ$	
			λ	$t_{A.S}^\circ C$	λ	$t_{A.S}^\circ C$	λ	$t_{A.S}^\circ C$	λ	$t_{A.S}^\circ C$
1	1500	1.175	1.157	22.8	1.14	22.6	1.125	22.3	1.122	22
		2.88	1.127	22.8	1.125	22.7	1.12	22.7	1.12	22.65
		3.8	1.189	22.7	1.15	22.3	1.12	22.3	1.12	22.1
		7.26	1.046	22.7	1.03	22.3	1.032	22.2	1.025	22.0
2	1800	7.695	1.097	23.2	1.09	23	1.09	22.6	1.09	22
		11.54	1.09	23.2	1.08	22.8	1.07	22	1.07	21.2
		15.39	1.15	23.1	1.12	22.7	1.11	22.3	1.11	21
		22.57	1.05	23.1	1.04	22.2	1.03	21.6	1.03	20.1
3	2100	8.97	1.095	22.1	1.09	21.5	1.08	20.1	1.08	19.8
		13.46	1.096	22	1.093	21.5	1.08	20	1.07	19.6
		23.93	1.022	21.6	1.02	21.3	1.01	20	1.015	19.6
		28.43	1.19	21.6	1.09	21.3	1.07	19.6	1.07	19
4	2400	10.2	1.046	21.9	1.035	19.2	1.03	18.1	1.03	18
		15.3	1.156	21.8	1.11	18	1.09	17.8	1.09	17.2
		27.3	1.126	21	1.13	18	1.11	16.6	1.1	16.5
		32.3	1.126	21	1.08	18	1.07	16.5	1.07	16.5

Also, from tests results, the cylinders No.1 and No. IV were found to be the worst in mixture quality without swirler. Table (III) shows the effect of swirler on mixture quality for cylinder No.IV. The effect of swirler on improving the mixture distribution along the intake manifold can be contributed to the increasing of heat transfer coefficient due to swirling velocity. The activity of high rate of heat transfer leads to high rate of mass transfer between two phases of flow. For this reason the mixture temperature at the outlet of swirler decreased as shown in table(III).

The aspect of this parameter provides a good evaporation of liquid fuel droplets. These fine droplets have a long life and can not be condensed easily on the inlet manifold walls.

2- Effect Of Swirler Angle On The (b.s.f.c).

The results of brake specific fuel consumption are plotted as a function of engine speed in fig.(6). The swirler with ($\theta=30^\circ$) decrease the (b.s.f.c.) of the engine, when it is running at any speed and load. The save of fuel consumption increases with increasing the load for all ranges of speeds. But the percentage of this saving decreases when the engine running up to 1800r.p.m.; Figs.(6a,6b,6c and 6d). From this results it can conclude that, the swirler of ($\theta=30^\circ$) improves the mixture distribution for all ranges of loads and speeds, but the affect is less for high speed than medium speed running. For swirlers with ($\theta=20^\circ$ and $\theta=40^\circ$), the effect of these types of swirlers are varried with engine speeds. The b.s.f.c. decreases with increasing load for these types when the engine running up 1800r.p.m.; figs. 6a and 6b. The effect of swirler($\theta=20^\circ$) is more in saving (b.s.f.c.) than swirler($\theta=40^\circ$).

For engine speeds up to 1800r.p.m. the b.s.f.c. were increased when swirlers ($\theta=20^\circ$), ($\theta=40^\circ$) were being used.

From these results, it can concluded that, the raising of b.s.f.c for swirlers($\theta=20^\circ$, $\theta=40^\circ$) and small rate of saving for ($\theta=30^\circ$) of speeds up 1800r.p.m. contributes to mixture quantity.

3- Effect Of Swirler On The Volumetric Efficiency(η_v).

The volumetric efficiency is affected by two factors, the increase of friction and irreversibility of mixture decrease(η_v), the decrease of mixture temperature increases(η_v). When the swirlers used the friction loss increases and the mixture charge temperature decrease. The net result of swirler on the (η_v) decreases for all ranges of loads and speeds, fig.(7). Fig.(7a) shows the effect of swirlers on (η_v) is more affect at medium speed. Also, as a result of fuel evaporation in the mixture by using a swirler, the mixture specific volume becomes high, this aspect causes homogenous mixture and decreasing volumetric efficiency.

It seems; homogeny mixture from analysis of cylinder exhaust sample obtained (fig.5) and table (III); and the mixture qualities in engine cylinders become similar.

The charge mixture temperature after swirler decreased within a value of 10°C . This observation gives an argument that the heat transfer between droplet and air in mixture becomes sufficient to evaporate all fuel droplets when swirler up ($\theta=20^\circ$) used.

4- Effect Of Swirler On The Maximum Rate Of Pressure Rise (R.P.R.)_m

Combustion process can be studied by aid of pressure -crank angle diagram (P-φ) fig. (1). The maximum rate of pressure rise was affected by changing engine load, charge quantity , spark timing, residual gas and conditions of charge. For a constant charge in quantity and quality, is affected by kind of homogenous of the mixture. In these series of test, also the maximum rate of pressure rise change with swirler angle.

For various angle at constant speed and various loads the maximum rate of pressure rise as shown in fig.(8). For speeds up to 1800 r.p.m. the maximum rate of pressure rise decreases with increasing loads, figs.(8a),(8b). The minimum value of (R.P.R.)_m is obtained when swirler 30° used, which is less than either swirler 20° or 40°.

The decreasing of the maximum rate of pressure rise is attributed to improvement of mixture quality and quantity in the engine cylinder.

For this reason the quantity of fuel consumed in these engine speeds and loads, fig. (6a) and (6b), are decreased than that without swirler used . It seems from figs. (9a) and (9b) that, the exhaust gas temperature decreases in the case of using swirler.

For speeds up to 1800r.p.m. swirler improved the mixture quality. But engine speed is very important factor owing to the charge velocities inside cylinder , which is affected directly by it.

Increasing the charge velocities in engine manifold cause high pressure rise rats as shown in figs. (8c)and (8d). The exhaust gas temperature is decreased by using swirlers figs.(9c) and(9d).

-CONCLUSION;

From the experimental results it can conclude that:.

1- A type of swirler used in this work improves the mixture quality and quantity of the engine cylinder.

2- A swirler with angle 30 is suitable for all engine speeds and loads , which arise of engine brake thermal efficiency.

3- A type of swirler used in this work gives evenly gas pressure cycles.

4- The mixture temperature decreases after leaving swirler, which suggests use in hot climate zone or for high compression ratio engine.

5- The improvement of mixture quality by swirler used is suitable in cold climate which the fuel droplets does not condensate on the walls of charge manifold.

--REFERENCES;;

1- Taylor C.F. " The Internal Combustion Engine In Theory And Practice" vol. 2-1977 -MIT Press.

2- Arkhangelsky V. et al; " Motor Vehicle Engine" 1971 Mir Publ.

3- Mathur M. L. et al;" A Course In Internal Comb. Engines" 1981. Dhanpat Rai -Delhi.

- 4- Donahue R.W. et al, "A Study Of Mixture Distribution " S.A.E. Quart. Trans. October 1950 vol.4.
 - 5- Ma T.H: "" Effect Of Cylinder Motion On Combustion" I. Mech. Paper C 81/75.
 - 6- Bolt J. A. "The Effect Of Mixture Motion Upon The Lean Limit And Combustion Of Spark Ignition Mixtures" S.A.E. 1967 paper 670467.
-
-

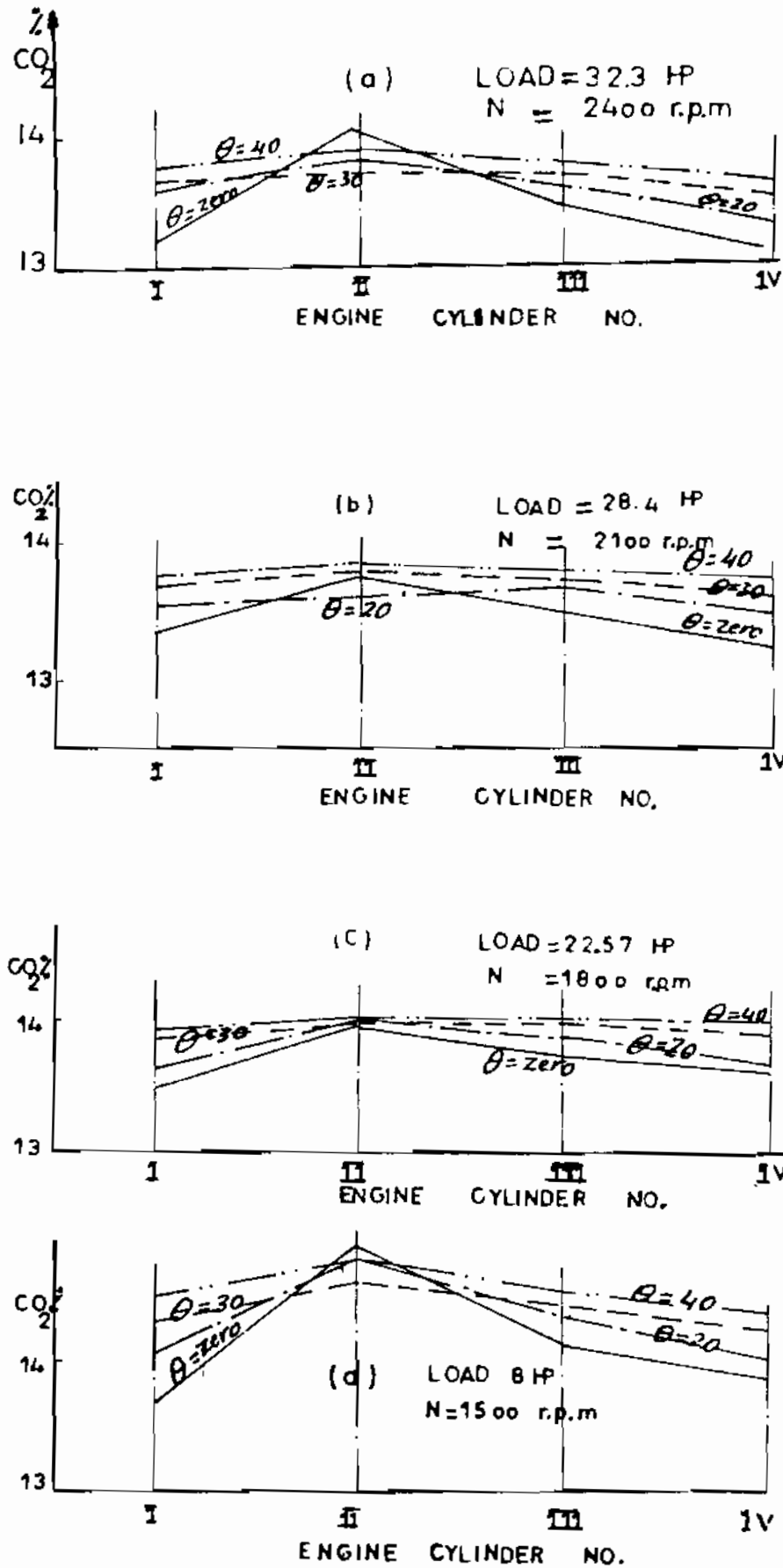
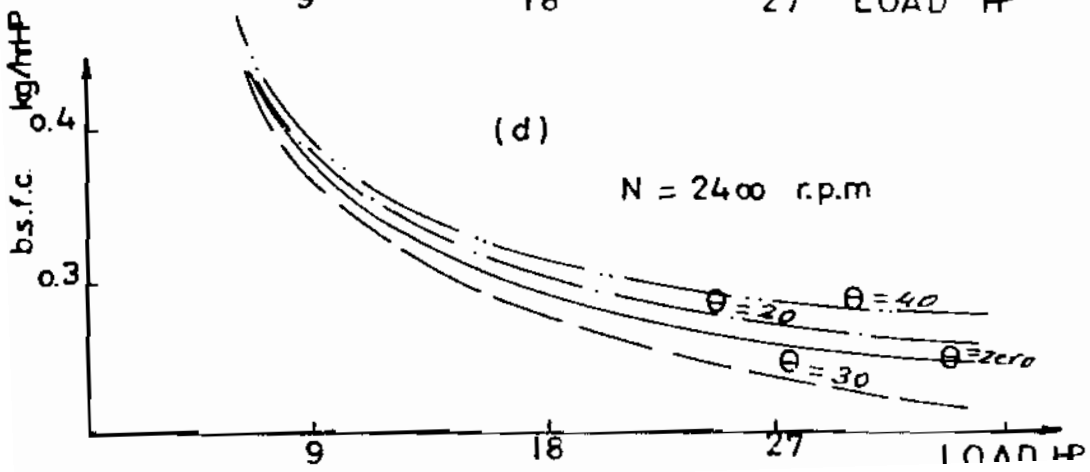
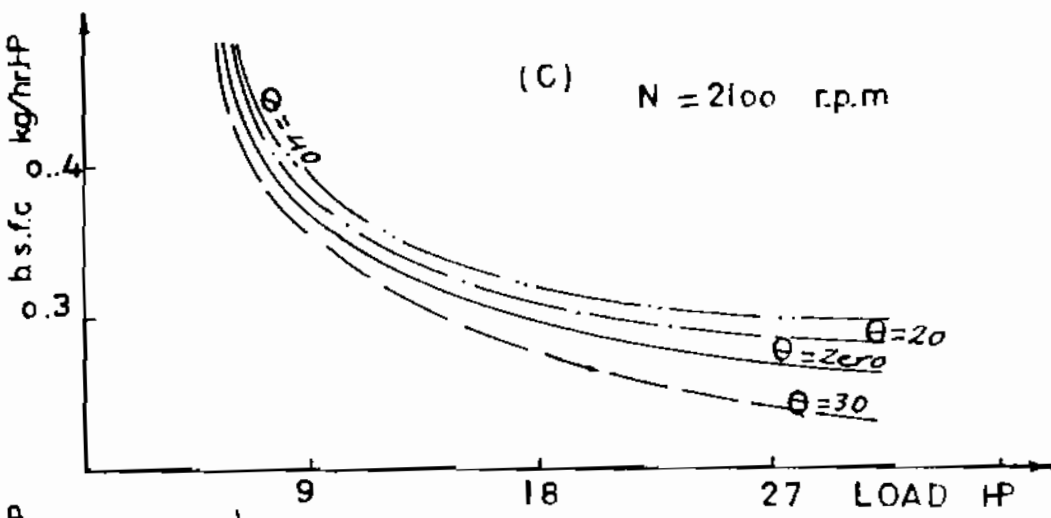
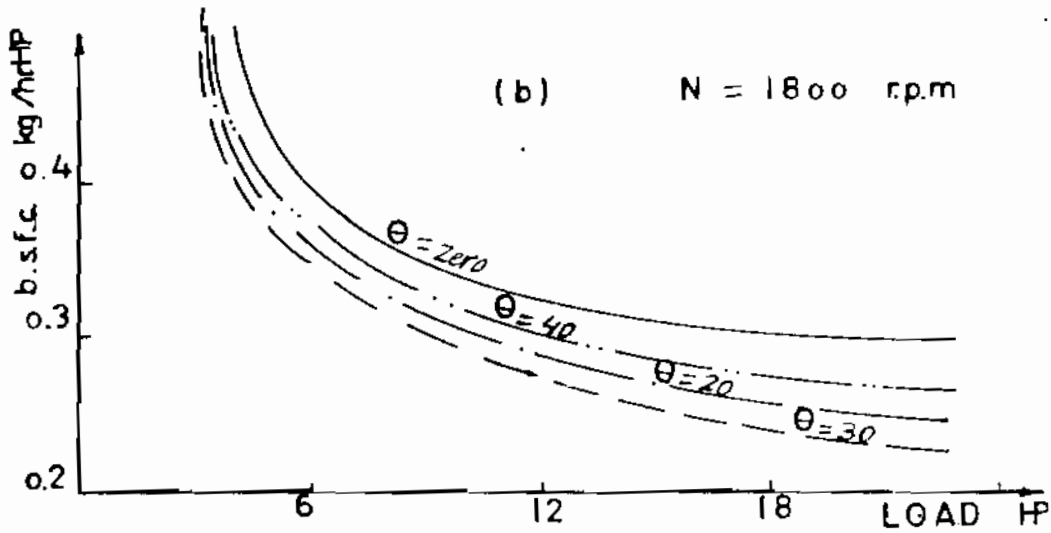
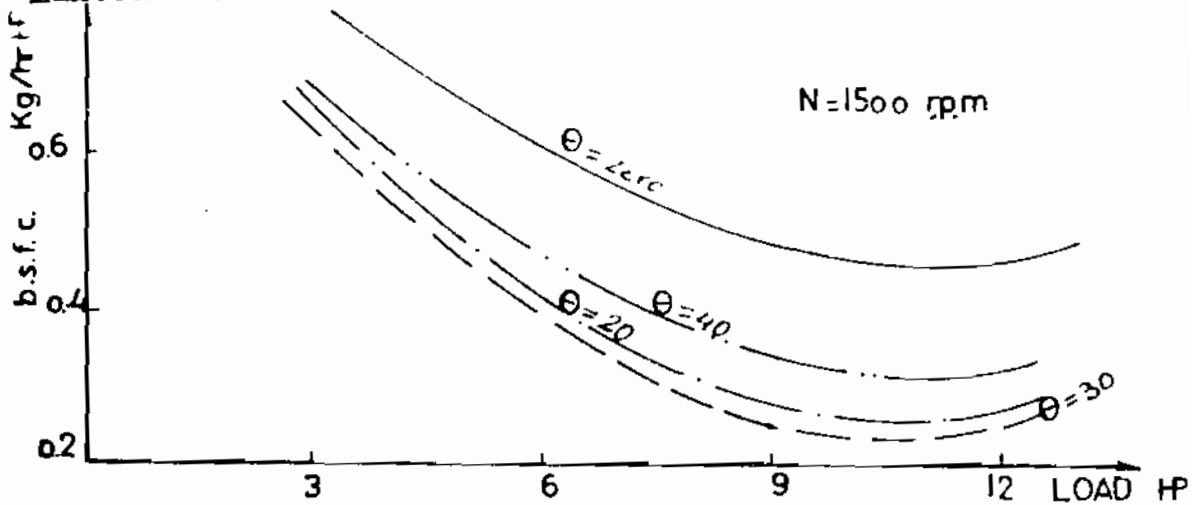

Fig.(5) Variation of carbon dioxide contents in exhaust gases of different engine cylinders.



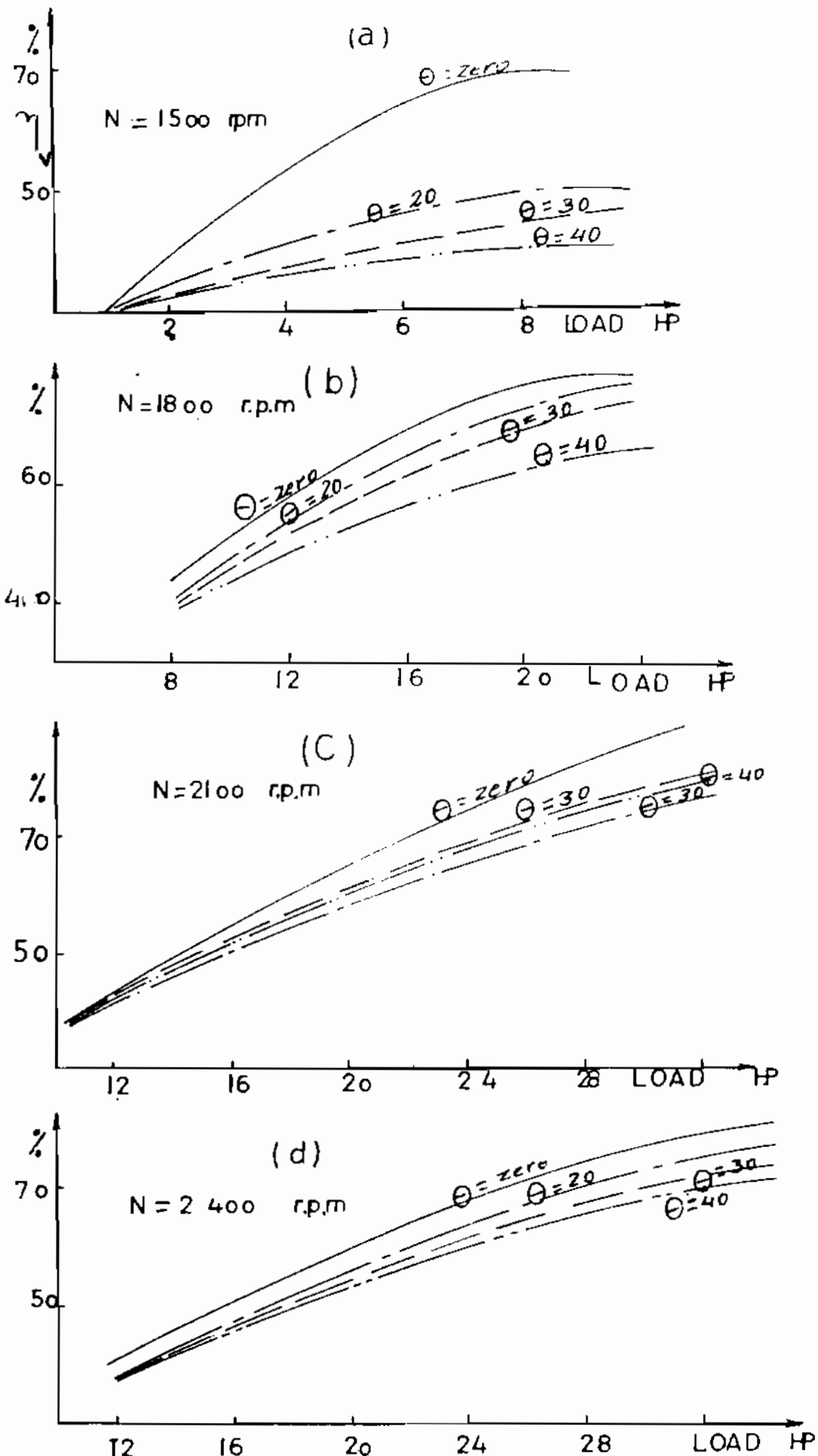

Fig.(7) Variation of volumetric efficiency

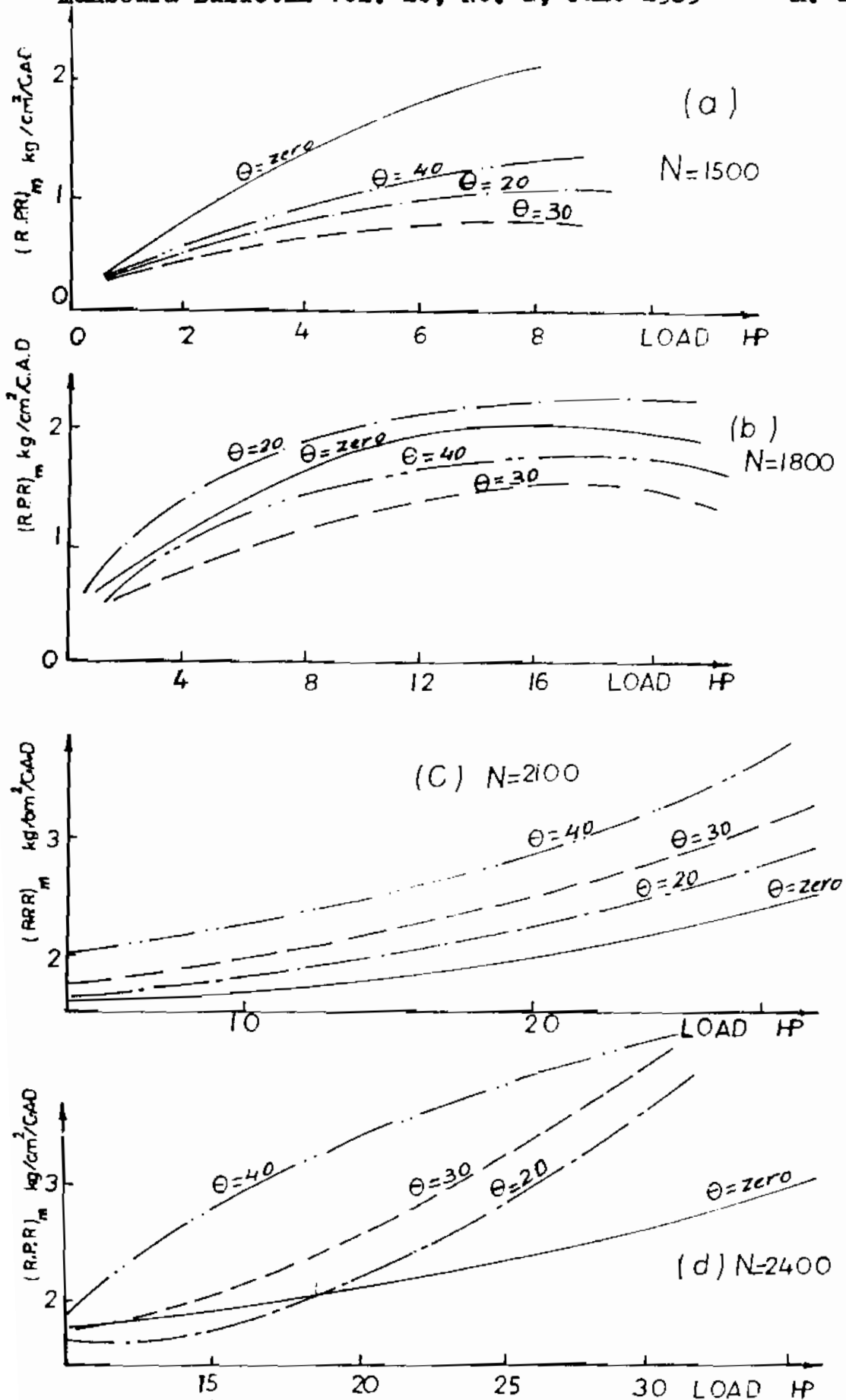

Fig. (8) Variation of maximum pressure rise rate

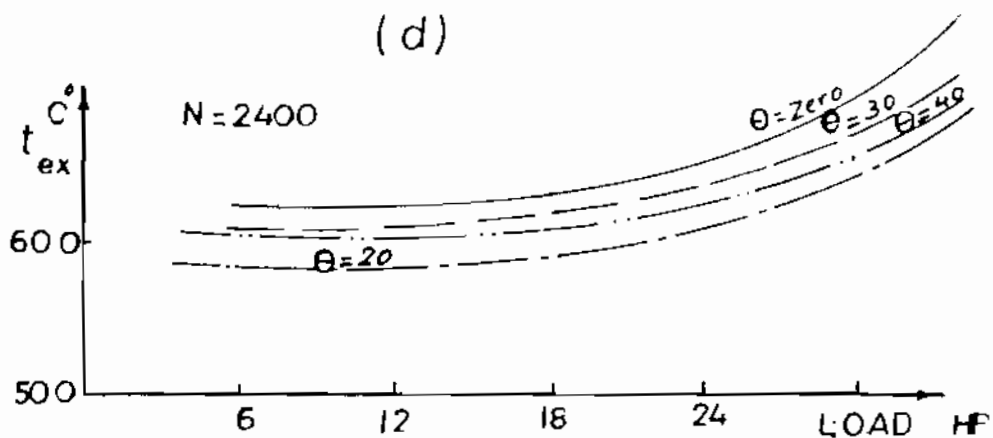
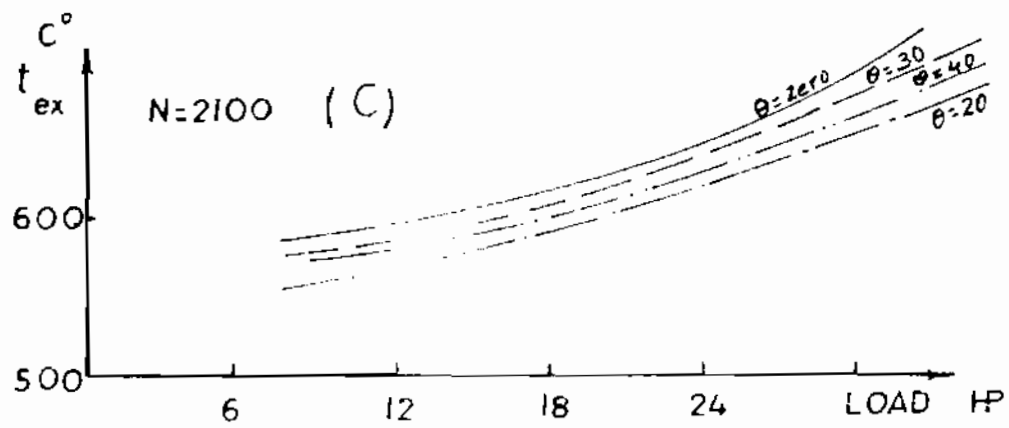
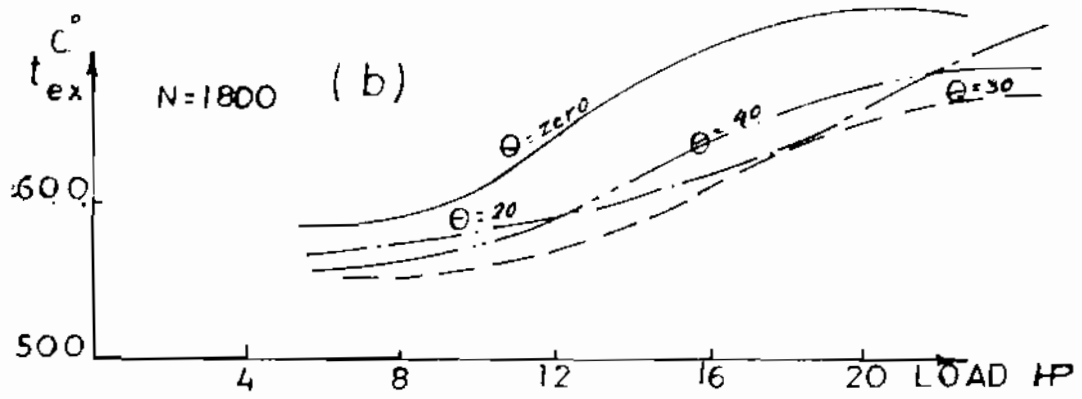
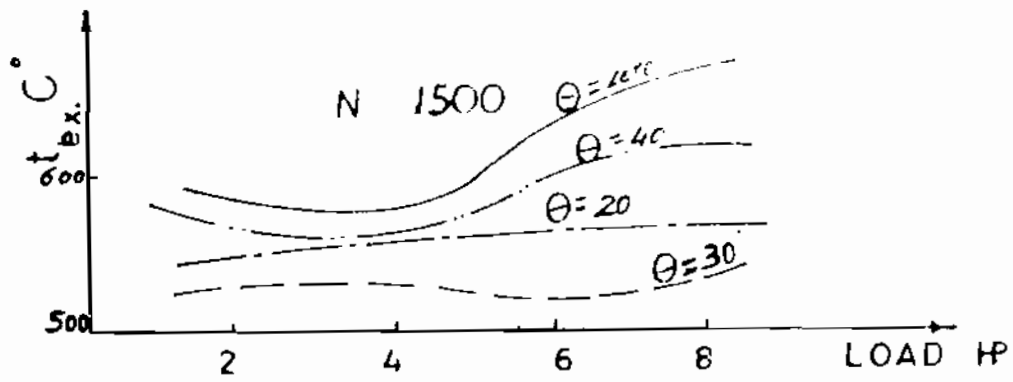

Fig.(9) Relations of exhaust gas temperature