

6-1-2021

Wear of Involute Helical Gears.

Ahmed El-Bahloul

Assistant Professor of Production Engineering Department, Faculty of Engineering, Mansoura University, Mansoura, Egypt.

Follow this and additional works at: <https://mej.researchcommons.org/home>

Recommended Citation

El-Bahloul, Ahmed (2021) "Wear of Involute Helical Gears.," *Mansoura Engineering Journal*: Vol. 12 : Iss. 1 , Article 11.

Available at: <https://doi.org/10.21608/bfemu.2021.174530>

This Original Study is brought to you for free and open access by Mansoura Engineering Journal. It has been accepted for inclusion in Mansoura Engineering Journal by an authorized editor of Mansoura Engineering Journal. For more information, please contact mej@mans.edu.eg.

WEAR OF INVOLUTE HELICAL GEARS

Dr. Ahmed M. M. EI-BAHLOUL

Lecturer, Production Engineering Department,
Faculty of Engineering, Mansoura University,

Mansoura, EGYPT

(Received April 9, 1987, accepted June 1987)

الخلاصة - المقالة توضح نتائج البحث المعملي الذي أجرى بمعامل كلية الهندسة جامعة المنصورة بهدف دراسة تأثير تغير الحمل العمودي على السنة ودرجة لزوجة الزيت وزاوية اللولبية الحلزونية على التآكل في المسننات الانفوليوبوتية اللولبية. مجموعة مختلفة من المسننات المختبرة خطوطها القطرية مقدارها 6 و قطر دائرة الخطوة مقدارها 91 مم وزوايا اللولبية الحلزونية مقدارها 22.3°, 33.6°, 42.25°. تم ادارتها في ماكينة اختبار المسننات بسرعات 1000 و 3000 لفة/دقيقة ونقلت أحمال عمودية على السنة تتراوح بين 1000 الى 3800 كغ. هذه المسننات زلقت بزيت اللزوجة الكينيماتيكية لها 200, 462, 653 cSt عند درجة حرارة 40°C. النتائج العملية أظهرت الآتي: التآكل يزداد بزيادة الحمل العمودي على السنة وزيادة زاوية اللولبية الحلزونية ويقل التآكل بزيادة لزوجة الزيت. مقدار التآكل في المسنن المنقاد أكبر منه في المسنن القائد تحت نفس ظروف التشغيل.

ABSTRACT

The paper presents the results of an experimental investigation carried out at Mansoura University Laboratories aiming at studying the effect of the change of applied tooth load, lubricating oil and helix angle on wear of involute helical gears. Different pairs of test gears of 6 D.P., 91.5 mm pitch diameter with 22.3°, 33.6° and 42.25° helix angles were run in power circulating gear test rig at speeds of 1500 and 3000 r.p.m and under different normal tooth loads ranging from 1000 to 3800 Kp. The gears were lubricated with oils of kinematic viscosities 200, 462 and 653 cSt at 40°C. Results show that wear increases with increasing tooth load and the helix angle, and decreases with increasing the oil viscosity. Wear of the driven gear is more than that of the driving gear under the same running conditions.

INTRODUCTION

Gears are designed according to their load carrying capacity for bending "strength failure" or load carrying for surface stress "wear, pitting and scoring failures". Many investigators (1-10)* studied wear of spur gears from different points of views of the operating conditions, using the power circulating gear test rigs or by simulation using disc machines, or from theoretical point of view. This paper presents the experimental results of the effect of change of the tooth load, helix angle and oil viscosity on wear for involute helical gears using power circulating test rig.

THE TEST RIG

The test rig is of the power circulating type where two pairs of gears are mounted on two shafts supported by rolling bearings as shown in Fig (1). The driving shaft has a graduated torque coupling to measure the transmitted torque. The driven shaft is composed of two parts connected together by a flange coupling. The rig is loaded by applying dead weights at the end of a lever fastened to each flange. Thus twisting each part of the shaft relative to the other. The rig is driven by a 8/10 HP A.C. motor running at speeds 1500 and 3000 r.p.m respectively. Careful attention has been given during test gears assembly to ensure proper alignment of the test gears and reducing the vibration level during the experimental tests.

TEST GEARS

The test gears were supplied by the General Electric Company Ltd, Rugby, England. The driving gear is made of MM 4155 steel and the driven gear is made of MM 4164 steel. The test gears are of 6 D.P. (4.23 module), 91.5 mm pitch diameter, 20° normal pressure angle, 1.2 contact ratio, 1.6 μ surface roughness and 99.967 mm blank diameter. They are of different helix angles, number of teeth and face widths. Table (1) gives the specifications of the test gears.

* Numbers in brackets designates references at end of paper.

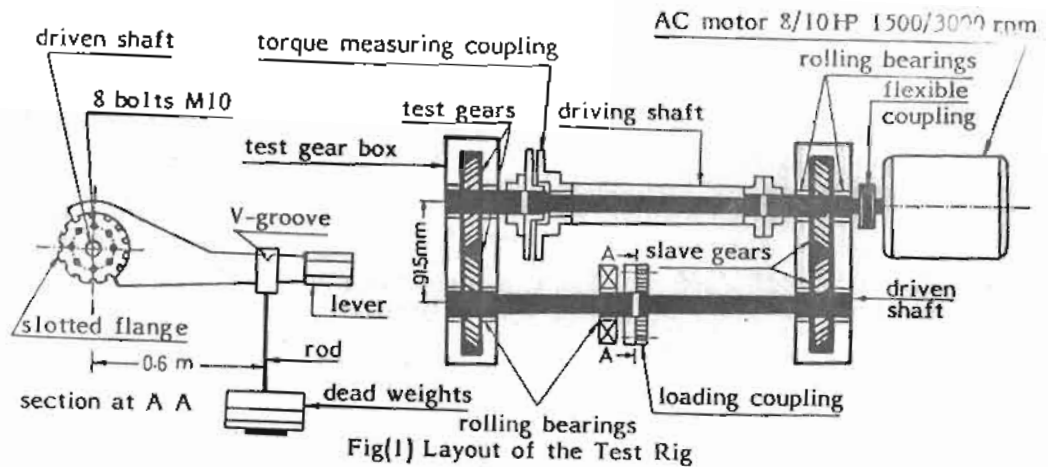

Table (1) Specifications of the Test Gears

Specifications	Test pair (1)	Test pair (2)	Test pair (3)
Helix angle, deg.	22.3	33.6	42.25
Face width, mm	42	29	24
Number of teeth	20	18	16
Axial pitch, mm	35	24	19.8

EXPERIMENTAL PROCEDURE

Gears under investigation were tested at tooth loads varying from 1000 to 3800 Kp, and speeds 1500 and 3000 r.p.m., the transmitted power ranges from 67 to 400 HP. The gears were dip lubricated in test oils of characteristics given in table (2). The lubricating oil were heated to $90 \pm 3^\circ\text{C}$ using heating coils, sensor and temperature indicator mounted on the test gear box to control the oil temperature.

Wear is measured by weighing the deposited removed metal by weighing the test gears before and after each test by a digital and analogue balance with accuracy of 1×10^{-5} gram and a capacity of 2000 gram, type Chyo Jupiter C2-2000, serial No. 30559 made in Japan. The test gears were washed before weighing by using an ultrasonic cleaning tank type No. 323/201, serial No. 337226, 40 KHz frequency, 150 watts output and 220x130x150 mm internal dimensions made in W. Germany and then dried by a stream of compressed air.

The total number of revolutions of the test driving and driven gears for each load stage is always constant namely 22500, and so the running time is variable with the revolutional speed.

Table (2) Characteristics of the Lubricating Oils

Characteristics	Oil (A)	Oil (B)	Oil (C)
Kinematic viscosity at	40 °C	653	200
	50 °C	333	118
	100 °C	32.4	17.6
Specific gravity	0.91-0.97	0.901	0.894
Pour point, max. °F (°C)	(-3)	5 (-15)	-10(-23)
Flash point, min °F (°C)	(260)	465(241)	405(207)
Viscosity index	70 average	95 min.	92 min.
Timken OK load 40 lb (18Kp)	- -	Passes	Passes

EXPERIMENTAL RESULTS AND DISCUSSION

A- Effect of Applied Tooth Load :

Fig (2,3) show the change of the weight of removed metal with the change of applied tooth load for the test pairs of involute helical gears with 22.3°, 33.6° and 42.25° helix angles at speed 1500 r.p.m using lubricating oils (A) and (B) respectively. Fig (4) shows the variation of the amount of wear with the increase of the tooth load for using different lubricating oils at speed 3000 r.p.m for test pairs (3) of 42.25° helix angle "the driving and driven gears". The trend of most of these curves shows that wear increases firstly at lower rate with nearly linear relation till the points of failure where the wear curve shoots up at higher loads reaching ultimate values. Curves also show that wear of the driven gear teeth is more than that of the driving gear teeth. Fig (5) shows the change of percentage of increase of weight of removed metal for the driven and driving gears with applied tooth load for test pairs of involute helical gears of 22.3° helix angle at speed 1500 r.p.m using lubricating oils (A) and (B). Fig (6) shows the change of percentage of increase of wear for the driven and driving gears with tooth load for test pairs (3) of 42.25° helix angle at speed 3000 r.p.m using lubricating oils (A), (B) and (C). Mean values of percentage of increase of weight of removed metal for driven and driving gears at all tests are listed in table (3). This may be due to the fact that; the stresses in the dedendum area of the driven tooth surfaces are higher than elsewhere because of the smaller radii of tooth curvature, at the end of mesh of single tooth loading sliding velocity and surface temperature reaching higher values, the thermal stress is high, also the strength of material of the driving gear is greater than that of the driven gear, ultimate tensile strength of the driving gear is greater than that of the driven gear by 24%. Due to these factors wear of the driven gear is more than that of the driving gear

Table (3) Mean values of percentage of increase of weight of removed metal for the driven and the driving gears

Speed, r.p.m	Test pair (1)		Test pair (2)		Test pair (3)		
	Oil (A)	Oil (B)	Oil (A)	Oil (B)	Oil (A)	Oil (B)	Oil (C)
1500	77.16	72.29	58.41	76.85	65.75	80.41	95.1
3000	--	--	--	--	89.29	87.15	92.63

B- Effect of Oil Viscosity :

Fig (7) shows the change of weight of removed metal with oil viscosity for the driving and driven gears of test pairs of involute helical gears of 42.25° helix angle at different tooth loads using speed 3000 r.p.m. Fig (8) shows the change of weight of removed metal with oil viscosity at different applied tooth loads for test pairs (1 and 2) using speed 1500 r.p.m. They show very clearly that wear decreases with increase of the oil viscosity. With increase of viscosity the oil film increases which carries higher loads with continuous formation between contacting teeth. But for light viscosity oil film is liable for cutting under load together with its sensitivity to surface roughness and Hertzian deformations. Thus it could be concluded that the stability of oil film with higher viscosity decreases the amount of wear for contacting teeth under the same load and speed. Fig (9) shows the change of the amount of removed metal for the driving and driven gears of test pairs (3) of 42.25° helix angle with oil viscosity at different applied tooth loads using speed 1500 r.p.m. This curve shows that wear decreases with oil viscosity, but for higher viscosity with this pair of gears coefficient of friction may be increases, the heat generation increases, oil film formation is difficult, the value of wear slightly increases than that of oil with medium viscosity.

C- Effect of Helix Angle :

Fig (10,11) show the change of the amount of removed metal with the change of helix angle for the driving and driven gears at different applied tooth loads for speed 1500 r.p.m using lubricating oils (A) and (B) respectively. These curves show that the change of the helix angle

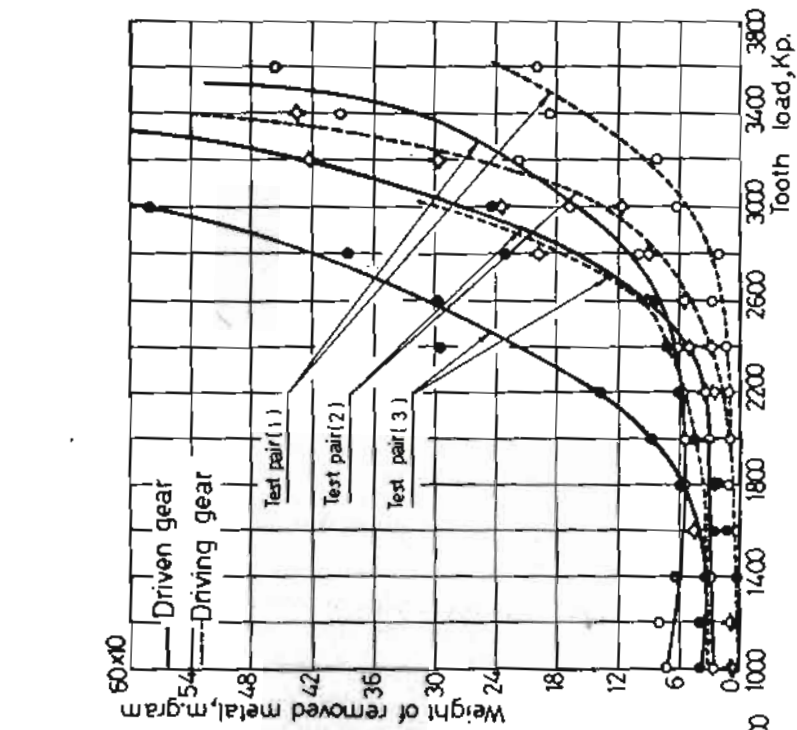

Fig[2] Change of weight of removed metal with tooth load for different test pairs of gears driving and driven gears using oil(A) at speed 1500 r.p.m

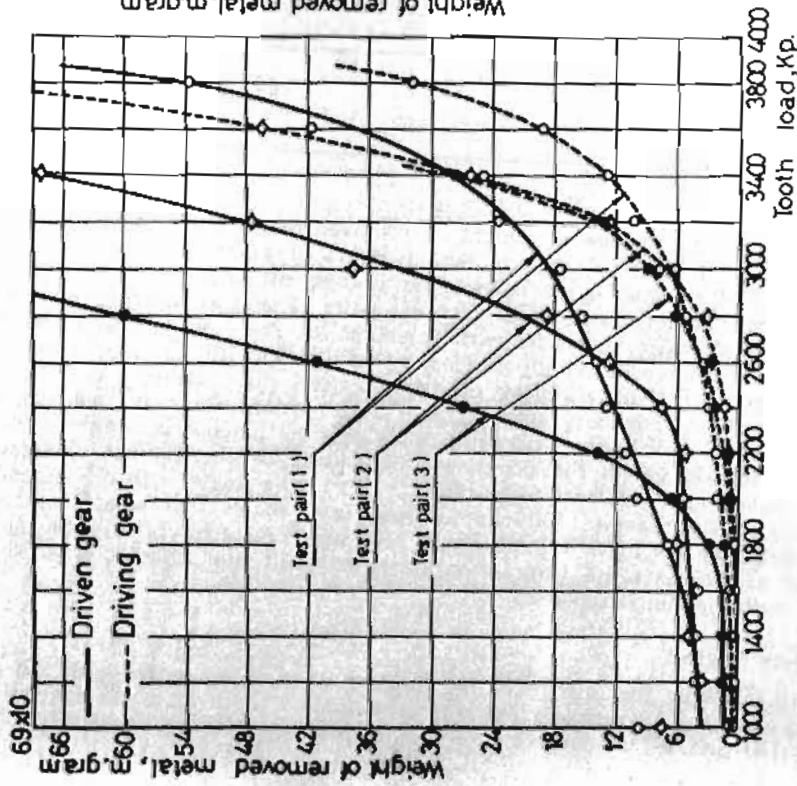

Fig[3] Change of weight of removed metal with tooth load for different test pairs of gears driving and driven gears using oil(B) at speed 1500 r.p.m

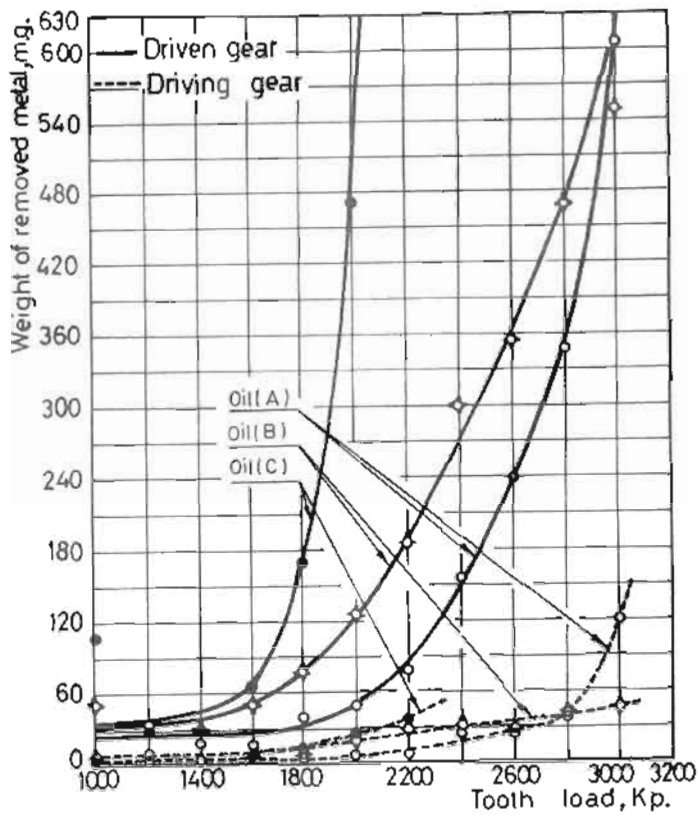

Fig(4) Change of weight of removed metal with tooth load at different lubricating oils for test pair(3) using speed 3000 r.p.m

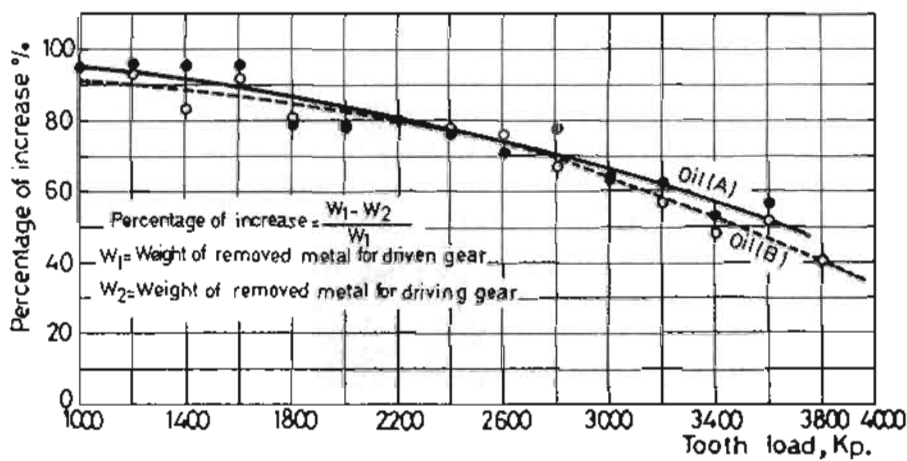

Fig(5) Change of percentage of increase of weight of removed metal for driven and driving gears with tooth load for test pair(1) at speed 1500 r.p.m using lubricating oils (A) and (B)

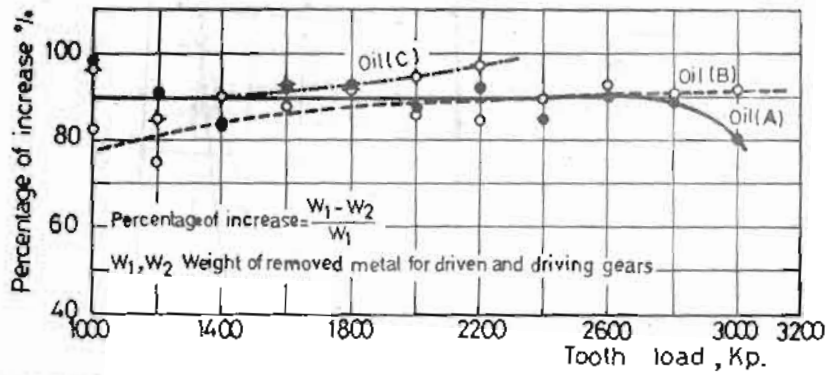
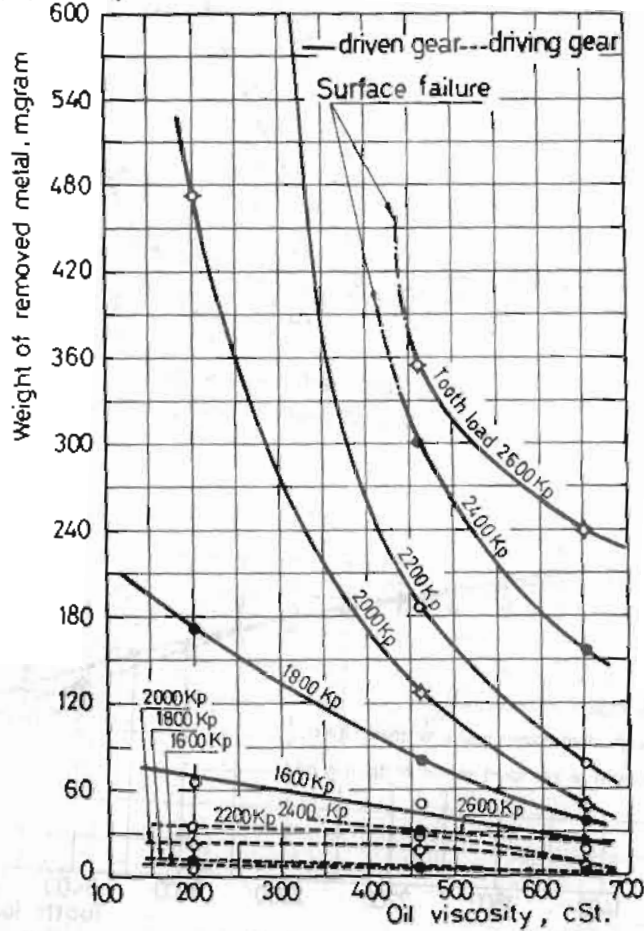
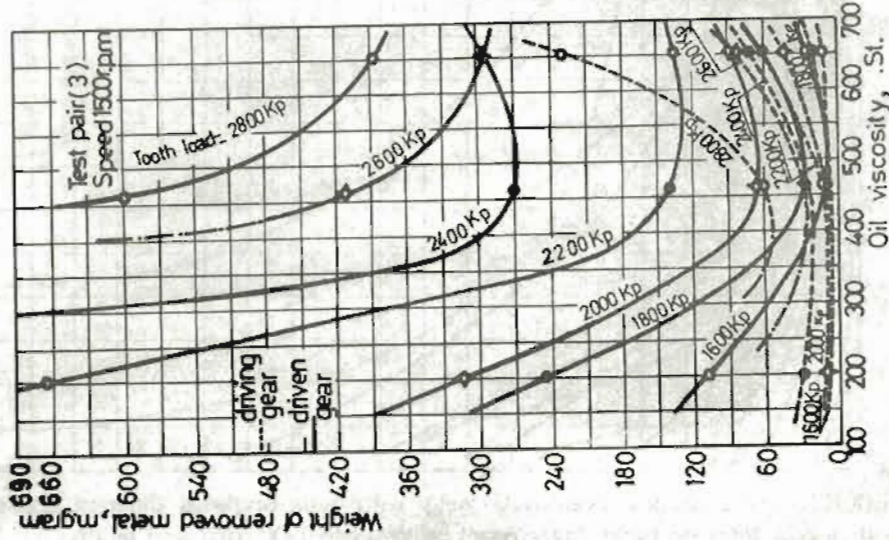

Fig (6) Change of percentage of increase of weight of removed metal for driven and driving gears with tooth load for test pair(3) at speed 3000.r.p.m using lubricating oils (A), (B) and (C)



Fig(7) Change of weight of removed metal with oil viscosity for driving and driven gears of test pair(3) at different tooth loads using speed 3000 r.p.m



Fig(9) Change of weight of removed metal with oil viscosity for driving and driven gears at different tooth loads

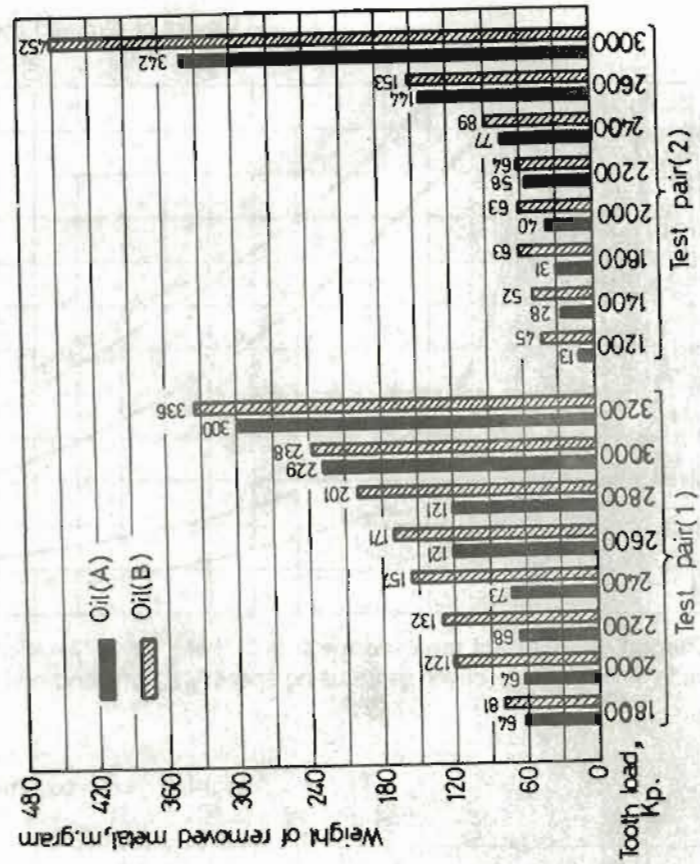

Fig(8) Change of weight of removed metal with oil viscosity at different applied tooth loads for test pairs (1 and 2) using speed 1500 r.p.m.

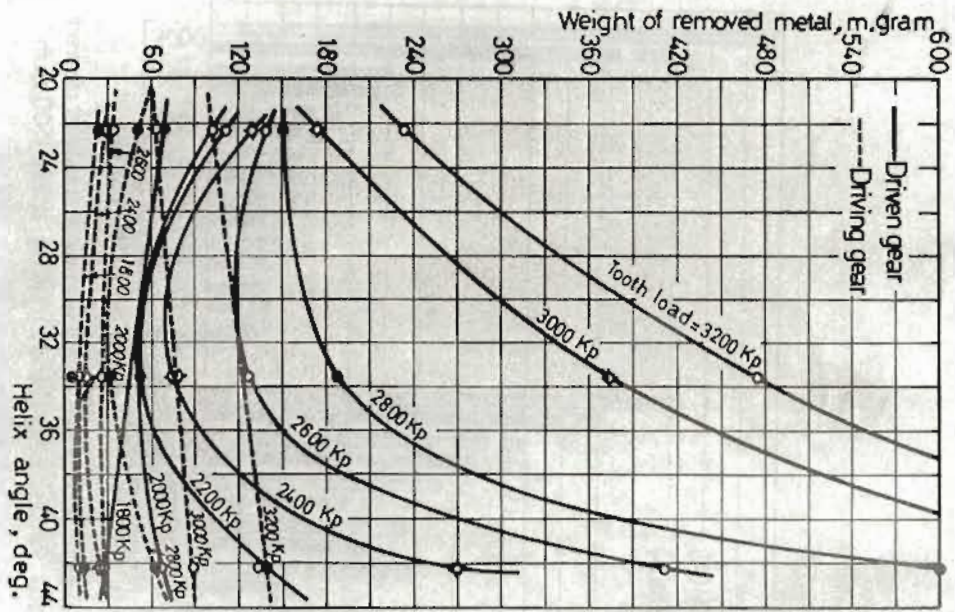

Fig(11) Change of weight of removed metal with helix angle at different applied tooth loads for driving and driven gears using speed 1500 r.p.m and oil (B)

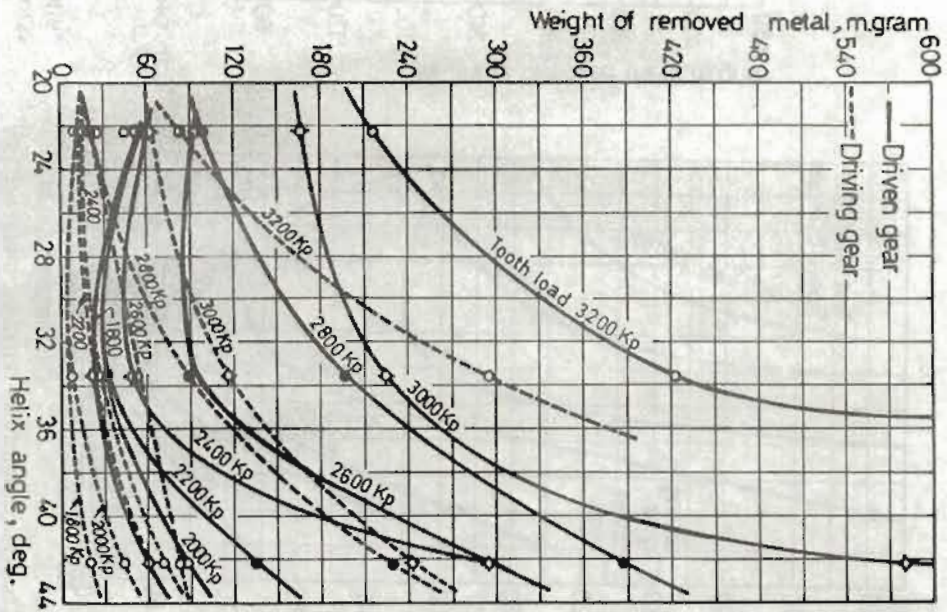

Fig(10) Change of weight of removed metal with helix angle at different applied tooth loads for driving and driven gears using speed 1500 r.p.m and oil (A)

increases wear with higher rate when the gears run under higher tooth loads. For light and medium tooth loads wear decreases at lower rate with the increase of helix angle reaching a certain minimum value and then increases again with higher rate. Tooth load per cm for test pair (3) is greater than that of test pair (2) and test pair (1), wear of test pair (3) is greater than that of test pairs (2) and (1).

CONCLUSIONS

- 1- Wear of involute helical gears increases at a uniform low rate at light and medium tooth loads followed by abrupt increases at higher loads.
- 2- Wear of test gears decreases with increasing the oil viscosity.
- 3- Wear of involute helical gears increases with higher rate with helix angle for higher applied tooth loads.
- 4- For light and medium tooth loads wear decreases at few rate with the increase of helix angle reaching a certain minimum value and then increases again with higher rate.
- 5- Wear of the driven gear is more than that of the driving gear for the same working condition and all the experimental tests, the mean values ranging from 58% to 95%.

REFERENCES

- 1- Borsoff, V.N., "Wear Studies with Radioactive Gears" Lubrication Engineering, Vol. 12, 1950, pp 24-28
- 2- "Gear Tooth Failures," Mobil Oil Corporation, New York, N.Y. 1967
- 3- Landen, E.W., "Slow Speed Wear of Steel Surfaces Lubricated by Thin Oil Film" ASLE Trans., 11 (1968) 6.
- 4- Goldman, L.B., "Corrosive Wear as a Failure Mode in Lubricated Gear Contacts" Wear, 14, (1969), pp 431-444.
- 5- Neale, M.J., "Tribology Handbook, Butterworths, London, 1973.
- 6- Czichos, H., "Tribology," Elsevier Scientific Publishing Company, Netherlands, 1978
- 7- Dudley D.W., "Characteristics of gear Wear" IFTOMM, Dubrovnik, Sept. 13-16, 1978.
- 8- Eisenstadt, R. and Thompson, R. "The Loss of Ideal Tooth Shape During Normal Gear Wear" IFTOMM, Dubrovnik, Sept. 13-16, 1978.
- 9- SAAD. M.F. "Effect of Impurities in Lubricating Oil on Scuffing and Wear of Gears"-International Symposium on Gearing and Power Transmissions, August 30-September 3, 1981, Tokyo, Japan.
- 10- Dudley, D.W., "Handbook of Practical Gear Design," McGraw-Hill Book Company, New York, 1984.