

5-26-2021

## New Solution Algorithm for Peak Shaving and Load Leveling using Photovoltaic/Battery Aggregation.

M. El-Maghraby

*Professor of IEEE Senior Member*

Mohamed Mohamed El-Sayes

*Assistant Professor of Electrical Power Engineering Department, Faculty of Engineering, Mansoura University, Mansoura, Egypt.*

Magdi El-Saadawi

*Electrical Power Engineering Department, Faculty of Engineering, Mansoura University, Mansoura, Egypt.,  
m\_saadawi@mans.edu.eg*

Follow this and additional works at: <https://mej.researchcommons.org/home>

---

### Recommended Citation

El-Maghraby, M.; Mohamed El-Sayes, Mohamed; and El-Saadawi, Magdi (2021) "New Solution Algorithm for Peak Shaving and Load Leveling using Photovoltaic/Battery Aggregation.," *Mansoura Engineering Journal*: Vol. 13 : Iss. 1 , Article 1.

Available at: <https://doi.org/10.21608/bfemu.2021.172527>

This Original Study is brought to you for free and open access by Mansoura Engineering Journal. It has been accepted for inclusion in Mansoura Engineering Journal by an authorized editor of Mansoura Engineering Journal. For more information, please contact [mej@mans.edu.eg](mailto:mej@mans.edu.eg).

NEW SOLUTION ALGORITHM FOR PEAK SHAVING  
AND LOAD LEVELING USING PHOTOVOLTAIC/BATTERY AGGREGATION.

خوارزم جديد لحل مشكلة تنعيم حمل الذروة وتسوية الأحمال مستخدماً

مجموعة خلايا كهروضوئية وبطاريات

M.H.EL. Maghraby

M.A. EL. Sayes

M.M.EL. Saadawy

Professor

Lecturer

Demonstrator

IEEE Senior Member

All with the Department of Electrical Power & Machines,  
Faculty of Engineering, EL-Mansoura University.  
EL-Mansoura, EGYPT

خلاصة - يعرض البحث المقدم لخوارزم جديد يتم بواسطة حل مشكلة تنعيم حمل الذروة وتسويته في فتراتها الزمنية لمنحنى التوليد التقليدي لمحطة قوى كهربية وذلك باستخدام منظومة خلايا فوتوفولتية وبطاريات تخزين . ويضع التشغيل الأمثل لمجموعة الخلايا الفوتوفولتية والبطاريات المذكورة عند ربطها بالشبكة العامة للعديد من الفجود العنسية والأعبادية ولذا فقد تضمن الاقتراح المذكور تطبيق ثلاثة طرق لتصميم هذه المنظومة بخلاف مما بناها أساساً في مصدر شحن البطاريات فيما إذا كانت الخلايا الفوتوفولتية فقط أو الشبكة العامة أو كلاهما معاً . وقد تم اجراء تحليل كمي كامل للتأثير المركب للعوامل الاقتصادية عند مستويات تخلل فوتوفولتية وذلك لتشغيل خلاياها دائماً عند نقطة أقصى قدرة للمودبول. وعند احضار أفضل طريقة من هذه الطرق وكذلك مستوى التخلل الملائم على قيمة الوفر السنوي المتوقع في المكاليف والنتائج عن استخدام الخوارزم المقترح عند استخدام مصادر التوليد التقليديه والذي يمكن أن يبلغ ٤٠٦٣١٧ دولار لكل كيلووات سوية . وعلى هذا يمكن اعتباره أداة فعالة وديقسة لاجاد الشكل المعدل لمنحنى التوليد التقليدي اليومي والممثل لكل شهر من شهور العام والمساعدة في تحديد مستوى التخلل المناسب لمطومة الخلايا الفوتوفولتية وبطاريات التخزين بالشبكة العامة مع تحديد دقيق للمصفيرات الاقتصادية التي يمكن الحصول عندها على أحسن وفر سوية .

**ABSTRACT** - In one of familiar and important past work in shaving the peak and leveling the load using Photovoltaic system/Battery storage (PV/BS) aggregation, the authors assumed their sizes as hypothetical numbers [1]. Moreover, a significant question of how the modified daily conventional generation curve be affected by different PV-penetration levels hadn't been answered. On other hand, this work hadn't investigated or analyzed the influence of PV/BS hardware prices and the PV-penetration level on the annual savings on using combustion turbines instead of the above aggregation.

So, our paper introduces a proposed solution algorithm to answer these questions provided with a complete numerical application for egyptian meteorological conditions. Operating the PV/BS combination with the utility grid has been optimized subject to a set of several and economic constraints. Three design concepts are thought of and suggested differed principally in the source of charging the battery either from PV and /or utility grid.

Entire quantitative analysis of the composite impacts of the economic parameters and penetration level of PV-array operating at its maximum power point has been performed and discussed. The best choice of the design concept to be applied and the adequate penetration level depends on the value of the levelized annual savings (LAS) on using the above aggregation instead of conventional generation units. It may have a value up to 406.317 \$/kW-year. This algorithm can, therefore, be considered as an effective tool in instituting accurately the modified daily conventional generation profile of twelve representative days of the year months. Moreover, it enables the designer to determine the applicable range of PV-penetration levels and economic parameters resulting in largest savings.

## 1 .INTRODUCTION

With the rapid increase in fuel price and its sensitivity to political conditions, increasing interest and attention have been emphasized on the development of electric supply utilizing renewable energy sources. Photovoltaic generation represents one such potential long-range conversion system particularly for sunny countries like Egypt [2].

One approach to evaluating combined Photovoltaic / Battery storage (PV/BS) plant would be to recognize the unique feature of PV and battery elements and operate them as part of a total utility system. In this way, both can be dispatched in the most efficient and economic way as dictated by established utility operating principles. Higher cost cycling and peaking units are started as the load increases and are throttled back or shut down as the load decreases and are throttled back or shut down as the load decreases. The incremental cost of generation during the peak period of the day can be significantly higher than that during the minimum load period. It is often possible to justify the storage of energy from the minimum load period for dispatch during the peak, referred to as "peak shaving". Thus, more base-type generation can be used effectively in place of peaking combustion turbine which consume scarce premium fuels [1].

The incremental cost of PV plants will be essentially zero, since there is no fuel cost and only a small variable O&M cost. Because the PV plants will have the lowest incremental cost of any generation on the utility system, power will be delivered from these plants to the power grid whenever it is available and to the maximum extent possible [1].

Throughout this past work in shaving the peak and leveling the load using PV/BS aggregation, the authors assumed their sizes as hypothetical numbers. Moreover, a significant question of how the modified daily conventional generation curve be affected by different PV-penetration levels, hadn't been answered. On other hand, it hadn't investigated or analyzed the influence of PV / BS hardware prices and the PV-penetration levels on the annual savings on using combustion turbines instead of the above aggregation.

So, our paper introduces a proposed solution algorithm to answer these questions provided with a complete numerical application for egyptian meteorological conditions. Operating the PV / BS combination with the utility grid has been optimized subject to a set of several technical and economic constraints. Using actual and continuous twelve solar radiation profiles for a calendar year. Three PV and BS design concepts are suggested and applied for different PV-penetration levels and PV-hardware and fuel prices. A comparative economic study has, thus, been performed and analyzed to differentiate between the cases of either using the combustion turbines or the PV / BS combination under several economic and PV-penetration levels. The levelized annual savings (LAS) in \$/kW-year is the index upon which this comparison depends. So, this work enables the designer to determine the applicable range of PV-penetration level and the economic parameters resulting in largest savings.

## GLOSSARY OF SYMBOLS

|          |  |
|----------|--|
| PV       | : Photovoltaic   |
| SCA      | : Solar cells  |
| BS       | : Battery storage  |
| mod.     | : Module   |
| $V_{mp}$ | : Maximum output voltage at certain solar radiation intensity, V |
| $i_{mp}$ | : Maximum output current at certain solar radiation intensity, A |
| $\eta_a$ | : Solar cell array efficiency , p.u.                             |
| $\eta_b$ | : Battery storage efficiency , p.u.                              |
| $\eta_p$ | : Power conditioner efficiency , p.u.                            |

- $\eta_R$  : Rectifier efficiency , p.u.  
 F.S : Factor of safety , p.u.  
 V.F : Variability factor , p.u.  
 DOD : Depth of discharge for battery storage, p.u.  
 k : Month order (For January k=1, ... For December k=12)  
 $N_k$  : Days of the  $k$ th month.  
 n : Day number (For January n=1, ... For December n=344)  
 $TL_v$  : PV-penetration level. , %  
 $MP_c$  : Daily maximum conventional generation power , MW.  
 $MP_{vi}$  : PV-maximum instantaneous power produced on the solar array basic module terminals,  $W_p/mod.$   
 $MP_{vk}$  : Highest value of the PV-maximum output power / module /day (n) of a certain month (k) ,  $W/mod.$   
 $E_{vkn}$  : PV-maximum output energy / mod./ day of the month considered, Wh  
 $E_{vk}$  : PV-maximum output energy / mod./ month, kWh.  
 $E_v$  : PV-maximum output energy throughout the year, kWh / year.  
 $E_{skn}$  : Surplus daily PV-output energy attainable on installing the largest solar array size, kWh / day.  
 $BC_{skn}$  : Battery storage capacity necessitated to accomodate the daily surplus energy for the month considered, kWh.  
 $BC_M$  : Largest battery storage capacity of the twelve ones required throughout the year , kWh.  
 $E_b$  : Battery storage output energy of  $BC_M$  througout the year, kWh.  
 $E_{ukn}$  : Daily input energy to charge battery storage from utility, kWh.  
 $E_{uk}$  : Monthly input energy to charge battery storage from utility, kWh.  
 $E_u$  : Yearly input energy to charge battery storage from utility, kWh.  
 $S_k$  : Solar array size for the month considered, mod.  
 $S_M$  : Largest solar array size of the twelve ones obtained throughout the year months, mod.  
 $S_m$  : Smallest solar array size of the twelve ones obtained throughout the year months, mod.  
 $S_{Bk}$  : Solar array size required to charge battery storage for the month considered, mod.  
 $S_{BM}$  : Largest size of the twelve  $S_{Bk}$  ones obtained throughout the year months, mod.  
 $c_a$  : Presentworth of solar cell array price ; \$ /  $W_p$   
 $c_b$  : Present worth of battery storage price ; \$ / kWh  
 $c_p$  : Present worth of power conditioner price : \$ / W  
 $c_1$  : Present worth of engineering, installation and project management costs, \$  
 $c_2$  : Present worth of annual operational & maintenance costs of PV/BS combination, \$  
 $R_{pv}$  : Present worth of battery storage replacement costs, \$  
 LAC : Present worth of land area cost , \$  
 SV : Per unit salvage value of replaced battery storage  
 TFC : Present worth of total first costs of combined PV/BS system ( $TFC = c_a * S_a + c_b * BC_M + c_p * TL_v * MP_c + c_1$ ), \$  
 TLCC : Total life-time cost of combined PV/BS system , \$  
 T : Life-time of conventional and PV/BS systems , Years  
 m : The number of component (BS) replacement over T years.

- d : The cost of money interest rate (discount rate), p.u.
- $f_1$  : The inflation rate for fuel price, p.u.
- $f_2$  : The inflation rate for equipment replacements, p.u.
- PWF : Present worth factor, p.u.
- AJ<sup>2</sup>C : Annual costs of the PV/BS combination, \$/year.
- $c_{fg}$  : Cost of fuel used for gas turbines, \$/kWh.
- $c_{fs}$  : Cost of fuel used for steam turbines, \$/kWh.
- AFC : Annual cost of fuel on using conventional system, \$/year
- AOC : Annual cost of O & M on using conventional system, \$/year
- DC : Present worth of conventional displaced units installation costs, \$
- ACC : Annual cost of conventional displaced units installation and operation costs, \$/year.
- ASC : Annual saving cost (ASC = annual cost of conventional displaced units minus the annual cost of conventional integrated with PV/BS system.
- LAS : Levelized annual savings, \$/kW-year
- LAS<sub>0</sub> : Zero Levelized Annual Savings, \$/kW-year
- LAS<sub>M</sub> : Largest Levelized Annual Savings, \$/kW-year.

## 2. STATEMENT OF PROBLEM

With a remarkable peak and load variations of a daily generation curve, it is conveniently economic to perform a peak shaving and a load leveling. In conventional power station the peak is met by working combustion turbines which have higher incremental cost in comparable with base generating units [3].

PV-array and battery storage have attractive advantages to replace these turbines since they have zero incremental costs in addition to other benefits [3]. One of the past and familiar work; fixed PV array and battery sizes used for this purpose with their periods of operation are chosen and not estimated.

However, if these sizes have been required to be economic with the corresponding appropriate operation times; it is necessary to solve the problem as accurate as possible taking into consideration all the imposed technical and practical constraints.

## 3. SOLUTION ALGORITHM

An accurate method is suggested to solve the imposed problem for the site under consideration. The computation steps can be summarized as follows :

- 1- For a continuous solar radiation profile of a representative day of each month of the calendar year; the PV-maximum instantaneous power produced on the solar array basic module terminals ( $MP_{vi}$ ) is measured for a solar radiation level each six minutes. The daily PV-maximum output power curve can then be drawn for each month [2].
- 2- A rational penetration level is selected as a percentage of the peak of the daily conventional generation curve [4]. So, the monthly solar array size expressed in a number of its module can be given by :

$$S_k = \frac{TL_v \cdot MP_{vi} \cdot F.S.}{MP_{vk} \cdot \sum_p V.F} \text{ mod. } \dots \quad (1)$$

where  $MP_{vk}$  is the highest value of PV-maximum output power per module of certain month

which is found according to the respective solar radiation level. The PV maximum output energy per day of the month under consideration (k) is thus computed by :

$$E_{vn} = E_{vkn} * S_k * 10^{-3} \quad \text{kWh / day} \quad \dots (2)$$

3- Till this point, there are three design concepts shown schematically in Fig.1, while the flow chart of the proposed solution algorithm is displayed in Fig.2. Thus :

3-1 With the first design concept, I, the largest number of solar array modules ( $S_M$ ) out of the twelve figures estimated for the year months has been installed. The battery storage, in this case, is to be charged from the attainable surplus energy and utility. So, the PV-array output energy throughout the year ( $E_{vI}$ ) is given by :

$$E_{vI} = \sum_{k=1}^{12} E_{vkn} * S_k \quad \text{kWh / year} \quad \dots (3-1)$$

where,

$$E_{vkn} = E_{vkn} * N_k * 10^{-3} \quad \text{kWh / mod. / month} \quad \dots (3-2)$$

Since the largest size of PV solar array ( $S_M$ ) is installed, this results in a daily surplus energy obtained monthly,  $E_{skn}$ , where:

$$E_{skn} = (S_M - S_k) * E_{vkn} * 10^{-3} \quad \text{kWh / day} \quad \dots (4)$$

Of course, there is no surplus energy if  $S_k = S_M$

The capacity of the battery accommodating this energy ( $BC_{skn}$ ), differs monthly where :

$$BC_{skn} = E_{skn} \quad \text{kWh} \quad \dots (5)$$

The largest capacity of the twelve ones required throughout the year is, thus, found and may be denoted as  $BC_M$ . With this concept it is assumed that this battery has been charged to its full capacity by the aid of the utility, that is to say,  $BC_M$  is completely and permanently charged throughout the year where its yearly outputs can be given by :

$$E_b = BC_M * \eta_b * DOD * 365 \quad \text{kWh / year} \quad \dots (6)$$

On other hand, their daily, monthly and yearly input energy for charging supplied by the utility will be estimated respectively as follows :

$$E_{ukn} = (BC_M - BC_{skn}) / \eta_R \quad \text{kWh / day} \quad \dots (7-1)$$

$$E_{uk} = E_{ukn} * N_k \quad \text{kWh / month} \quad \dots (7-2)$$

$$E_{uI} = \sum_{k=1}^{12} E_{uk} \quad \text{kWh / year} \quad \dots (7-3)$$

3.2 In the design concept, II, the minimum number of modules ( $S_m$ ) is only installed and the battery storage would totally be charged from the utility to have the same capacity on applying the other concepts. This size is chosen out of the twelve ones of the year months. Thus, the yearly PV energy of these modules can be computed from :

$$E_{vII} = \sum_{k=1}^{12} E_{vk} * S_m \quad \text{kWh / year} \quad \dots (8)$$

The daily and annual input energy to charge the BC<sub>M</sub> battery by the utility can, then, be deduced as follows :

$$E_{un} = BC_M / \eta R \quad \text{kWh / day} \quad \dots (9-1)$$

$$E_{uII} = E_{un} * 365 \quad \text{kWh / year} \quad \dots (9-2)$$

3.3 Applying the third concept, III, the minimum number of modules has been installed but the battery storage is to be charged from an additional PV-modules (S<sub>Bk</sub>), i.e. there is a changeable monthly array size for charging the battery where :

$$S_{Bk} = \frac{BC_M * F.S.}{E_{vkn} * V.F. * 10^{-3}} \quad \text{modules} \quad \dots (10)$$

Out of these twelve sizes, the maximum one is determined, (S<sub>BM</sub>) which will be installed resulting in surplus energy throughout the year given by :

$$E_{sIII} = \sum_{k=1}^{12} (S_{BM} - S_{Bk}) * E_{vk} \quad \text{kWh / year} \quad \dots (11)$$

This PV surplus energy is superimposed on that of the original array to levelize the generation curve, where the global PV-energy for this purpose is given by :

$$E_{vIII} = E_{vII} + E_{sIII} \quad \text{kWh / year} \quad \dots (12)$$

The problem is thus solved for the following conditions :

- a- Site; daily conventional generation curve, solar radiation profile with its coefficients and subjected reliability level.
- b- Recent types of modules and batteries with their specifications.
- c- Alternative fuel, solar array modules and battery storage prices reflecting the present and future conditions.
- 4- An economic study is made to determine the most economic conditions of operating PV/BS aggregation in the utility context. The differentiation depends on the difference between the annual costs of conventional generation displaced units (ACC), and the annual costs of the PV/BS combination (APC). The first one is calculated applying the following mathematical relations [4] :

$$PWF = \frac{1}{d-I_1} \left[ 1 - \left( \frac{1+f_1}{1+d} \right)^T \right] \quad \dots (13)$$

$$AFC = E_v * C_{fs} + E_b * C_{fg} - E_u * C_{fs} \quad \$ / \text{year} \quad \dots (14)$$

$$ACC = AFC + AOC + (DC/PWF) \quad \$ / \text{year} \quad \dots (15)$$

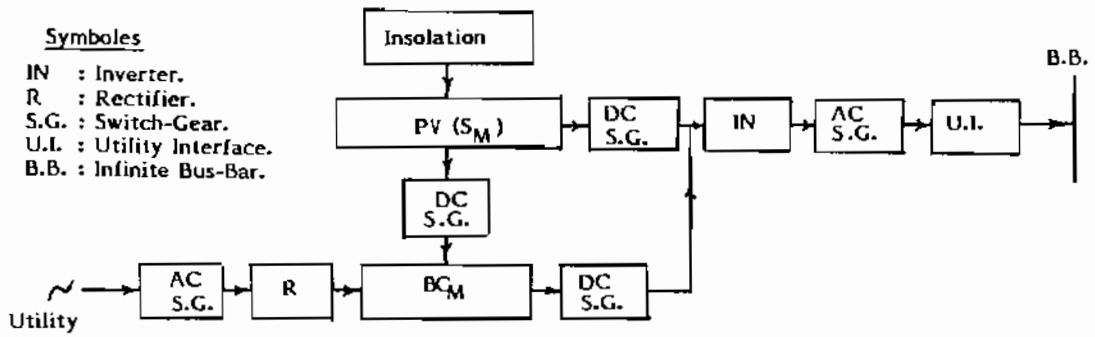

Fig. 1-a Design Concept I

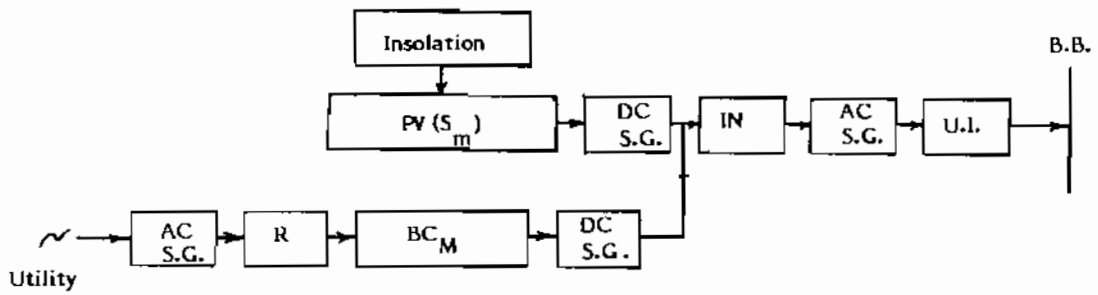

Fig. 1-b Design Concept II

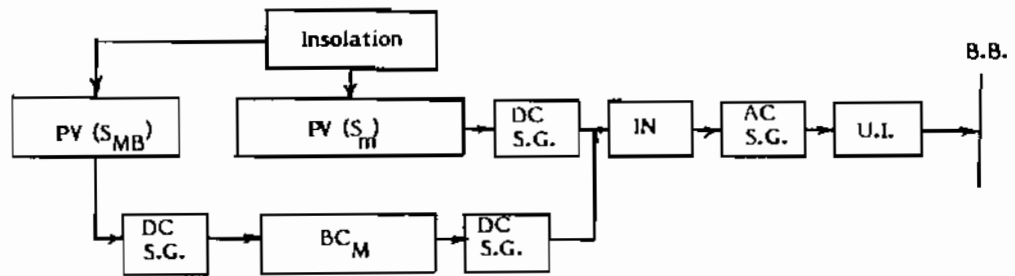
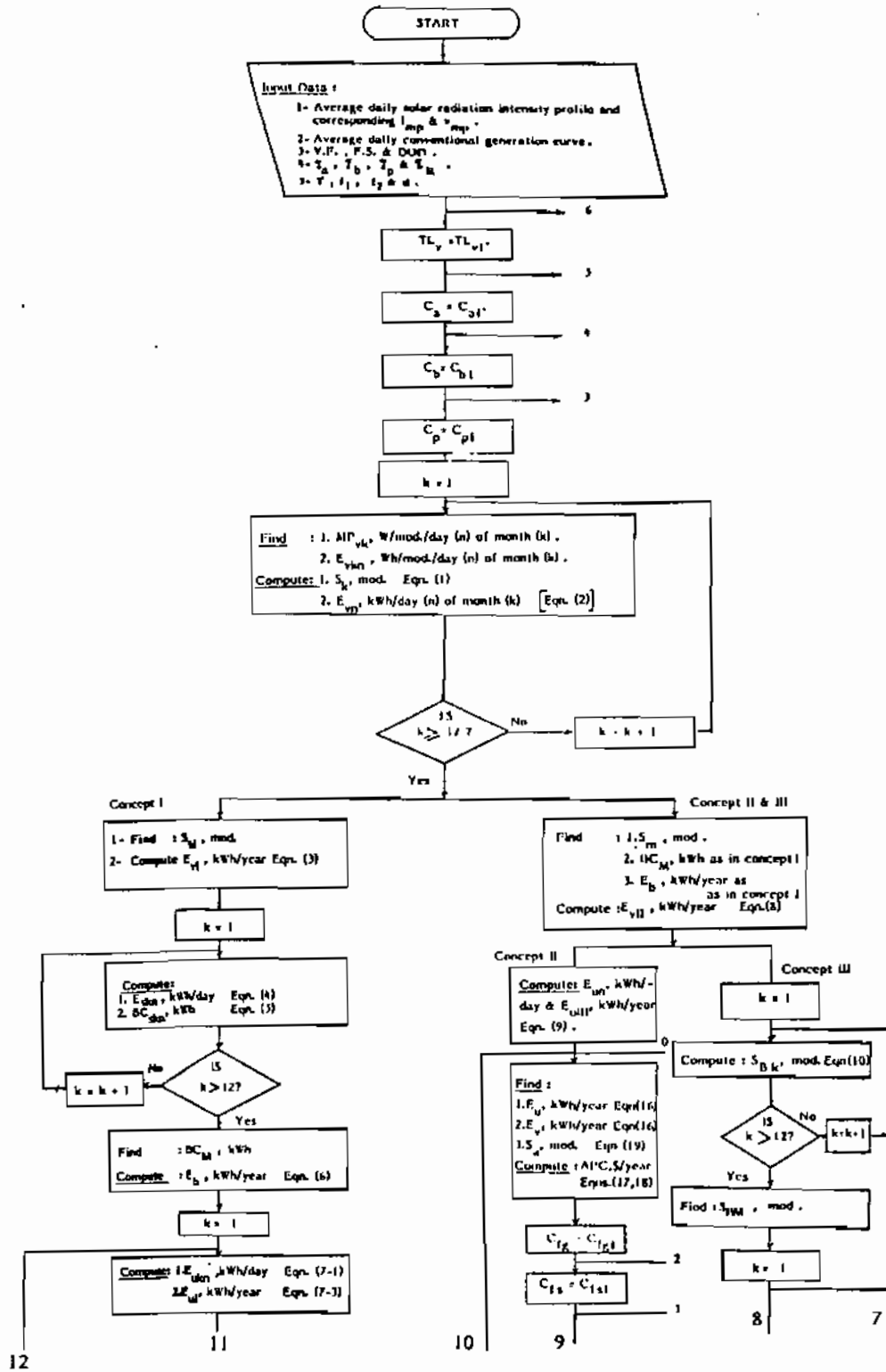

Fig. 1-c Design Concept III

Fig. 1 Schematic Diagram of the proposed design concepts.





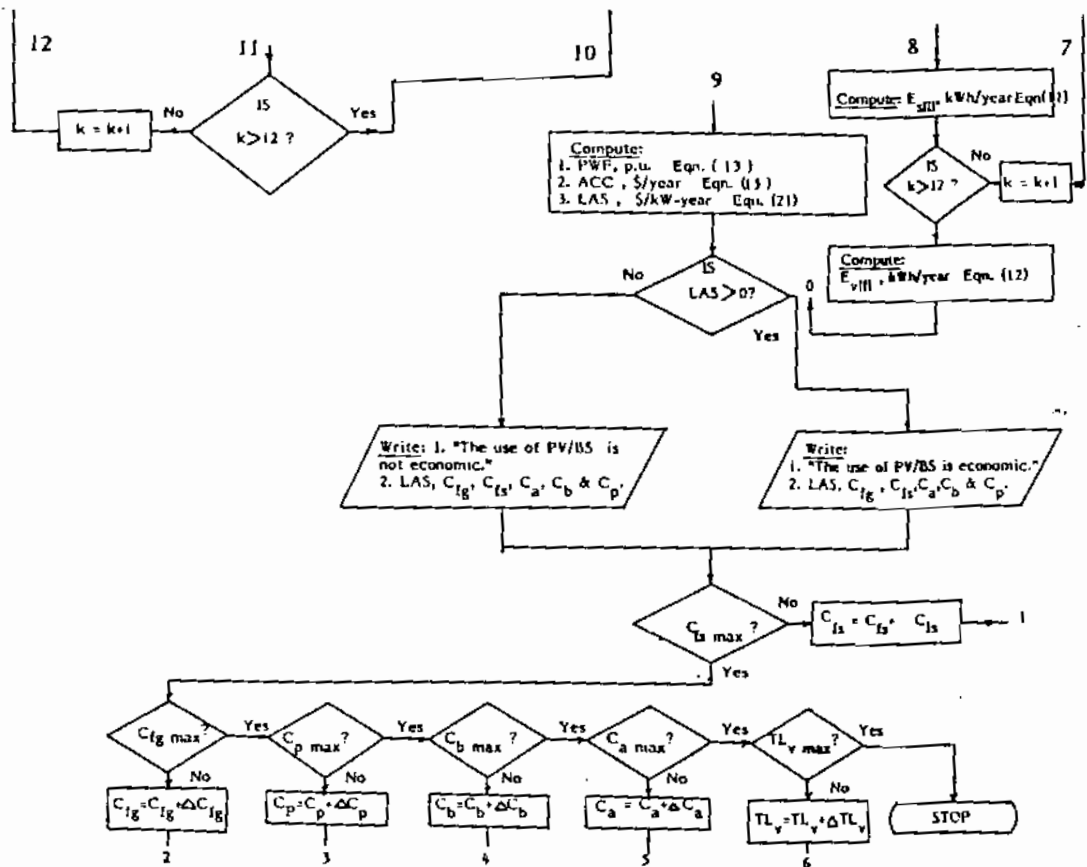

Fig. 2 Flow chart of the proposed solution algorithm .

where

- . AFC & AOC are the annual cost of fuel and M & O of conventional displaced units.
  - . DC is the conventional displaced unit installation cost (\$).
  - .  $E_v$  &  $E_u = E_{vI}, E_{uI}$  on applying Design concept I
- |                      |   |   |   |   |   |     |   |          |
|----------------------|---|---|---|---|---|-----|---|----------|
| $= E_{vII}, E_{uII}$ | " | " | " | " | " | II  | } | ... (16) |
| $= E_{vIII}, 0$      | " | " | " | " | " | III |   |          |

The annual cost of PV/BS aggregation used for load leveling and peak shaving purposes respectively, are estimated by the aid of the following equations [5]:

$$APC = TLCC / PWF . \quad \$ / \text{year} \quad \dots (17)$$

where  $TLCC = TFC + c_1 + c_2 + R_{pv} + LAC \quad \$ \quad \dots (18-1)$

$$TFC = S_a * c_a + BC_M * c_b + TL_v * MP_c * c_p \quad \$ \quad \dots (18-2)$$

$$c_1 = 0.17 * TFC \quad \$ \quad \dots (18-3)$$

$$c_2 = 0.01 * (S_a * c_a + BC_M * c_b) * PWF1 \quad \$ \quad \dots (18-4)$$

$$R_{pv} = BC_M * c_b * (1-SV) * \sum_{i=1}^m \left( \frac{1+f_2}{1+d} \right)^i \frac{1}{i+1} \quad \$ \quad \dots (18-5)$$

&

|                  |                            |   |   |          |
|------------------|----------------------------|---|---|----------|
| $S_a = S_M$      | on applying Design concept | I | } | ... (19) |
| $= S_m$          | "                          | " |   |          |
| $= S_m + S_{BM}$ | "                          | " |   |          |

so the difference ASC is estimated by :

$$ASC = ACC - APC \quad \$ / \text{year} \quad \dots (20)$$

and the levelized annual saving costs (LAS) is obtained by dividing the annual saving costs by the PV-penetration level (kW) [2].

#### 4. NUMERICAL APPLICATION

The use of PV/BS aggregation for load leveling and peak shaving is economic when LAS has a positive value which is governed by several factors and conditions like : amount of peak shaving and depth of load leveling, fuel, solar array modules, battery storage and power conditioner prices, site parameters, economic factors : discount and inflation rate and the applied design concept.

The numerical application of this algorithm demonstrates the influence of these factors and its gradation with a specific penetration level. The most economic solution with this preselected level has been characterized by having highest figure of savings (LAS) on injecting the PV and BS outputs into the utility grid in the place of that of the conventional generation units.

Additionally, the problem has been solved for other penetration levels and thus the results can be summarized leading to the best and appropriate level with the corresponding solar array size and battery storage capacity with their periods of operation.

#### 4.1 Input Data :

The elements constituting these data are concerned with :

- a) Daily solar intensity profile for El-Mansoura site, Egypt.
- b) Average daily conventional generation profile.
- c) Solar cells module : type and characteristics.
- d) Battery storage being used.
- e) Design coefficients.
- f) Economic coefficients and parameters.

Displayed in the Appendix are representative daily solar radiation intensity patterns of summer and winter seasons recorded actually at the Direct Conversion Of Solar Energy Laboratory in our Department. The change of maximum power and respective current of the PV-module against the solar radiation intensity are plotted in the Appendix is the average daily conventional generation curve depicted in the Appendix. Hypothetically taken for the purpose of performing the task of load leveling and peak shaving.

Other technical and economical details will be mentioned in the Appendix.

#### 4-2 Results and Argument .

##### 4.2.1 Application of Solution Algorithm

This item exhibits the SCA and battery storage sizes installed on applying the proposed solution algorithm. These sizes obtained with the followed design concepts are tabulated in Tables 1 & 2. Although one can conclude that concept II is the best one, it is indispensable to perform a complete economic study taking into account the fuel and PV-hardware prices. This concept, as will be shown in the next items, is the most economic one only if the near future prices of the PV-components and low fuel prices can be achieved. So, the full analysis and discussion of these economic results are stated in the following items.

Table 1. Application of Solution Algorithm and Installed SCA & BS sizes for Different Design Concepts and Prescribed PV-penetration level ( $TL_v=5\%$ ).

| Design Concept<br>Item | I      | II     | III    |
|------------------------|--------|--------|--------|
| $S$ , array *          | 7373   | 5646   | 9942   |
| BC, MWh                | 750    | 750    | 750    |
| $E_b$ , MWh/year       | 221050 | 221050 | 221050 |
| $E_v$ , MWh/year       | 835286 | 741600 | 919210 |
| $E_u$ , MWh/year       | 174060 | 304167 | 0      |

\* Array consists of 1000 basic modules stated in the Appendix

Table 2. Application of Solution Algorithm and SCA & BS sizes for Investigated Design Concepts and Different Prescribed PV-penetration level.

| Item<br>TL <sub>v</sub> , % | Installed S size, array |        |        | B C, MWh |
|-----------------------------|-------------------------|--------|--------|----------|
|                             | I                       | II     | III    |          |
| 1                           | 1474.6                  | 1029.2 | 1988.4 | 150      |
| 5                           | 7373                    | 5646   | 9942   | 750      |
| 10                          | 14746                   | 11292  | 19884  | 1500     |
| 20                          | 29492                   | 22584  | 39768  | 3000     |

Table 3. Actual PV-penetration levels on Applying the Proposed Design Concepts with a Prescribed PV-penetration level of 5%

| D.con.      | Month |      |      |      |      |      |      |      |      |      |      |      |
|-------------|-------|------|------|------|------|------|------|------|------|------|------|------|
|             | J     | F    | M    | A    | M    | J    | J    | A    | S    | O    | N    | D    |
| Concept I   | 5     | 5    | 5    | 5    | 5    | 5    | 5    | 5    | 5    | 5    | 5    | 5    |
| Concept II  | 4.06  | 3.83 | 4.79 | 5    | 4.50 | 4.52 | 4.64 | 4.65 | 4.59 | 4.09 | 4.05 | 3.97 |
| Concept III | 4.24  | 3.93 | 6.02 | 6.69 | 5.97 | 6.11 | 6.28 | 6.27 | 5.65 | 4.69 | 4.31 | 3.97 |

Fig. 3-a exhibits the modified seasonal average daily conventional generation curves on applying the suggested design concepts. It is evident that the peak shaving and load leveling differ according to the PV-output and its period. The modified generation curve reveals that the amount of utility energy required in summer season to charge-partially the battery in concept I is less than that needed in the winter. Fig-3.b shows to what extent the original generation pattern will be modified and becomes more smoother on enhancing the prescribed penetration level from 5 to 20% .

On other hand, Table 3 explains the actual PV-penetration levels with the proposed concepts. It is noticeable that a constant level will be obtained monthly on applying concept I. However, with the other concepts, the PV-penetration level changes monthly due to the installation of an array having a size differs from the minimum one .

4.2.2 Impact Of Economic Parameters On Levelized Annual Savings :

Fig.4 reveals a linear behaviour of the levelized annual savings versus the solar cells array price with fuel costs as a parameter of 0.084 & 0.132 \$/kWh for gas turbines and 0.0376 & 0.0928 \$/kWh for steam ones [8]. Constant PV-penetration level of 5% (240 MW<sub>p</sub>) is assumed for this case. Moreover, the battery and power conditioner prices are taken to have 50 \$/kWh & 0.5 \$/W respectively [10][11]. The positive savings means real amount of money to be gained on using PV-array and battery storage instead of conventional generation units. However, the negative region indicates that the use of such system is not economic with the corresponding solar cell price.

The effect of design concepts is also quantitatively determined and the most economic

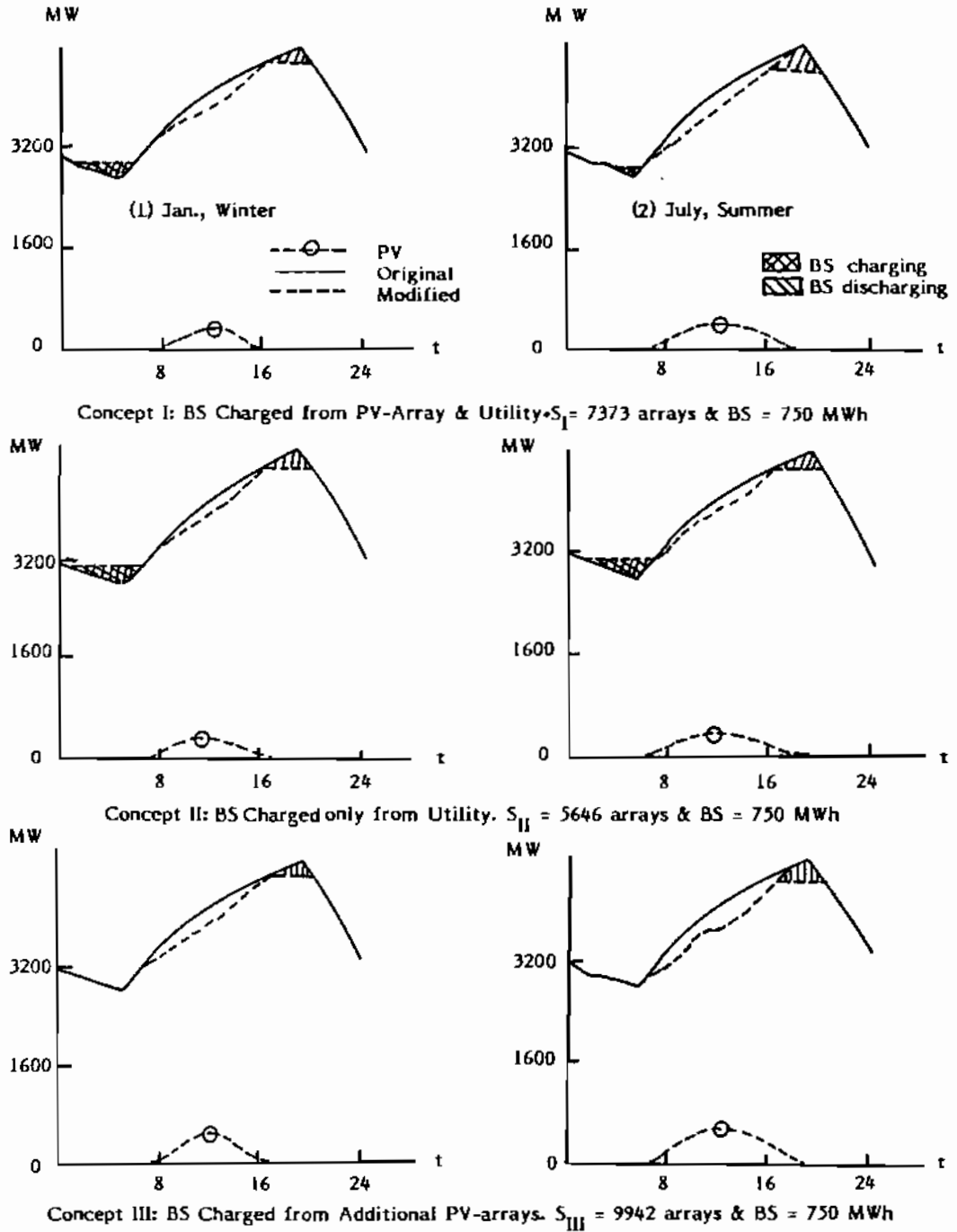

Fig. 3-a PV and Original & Modified Average Daily Conventional Generation Curves Applying the Proposed Design Concepts I, II & III, for  $TL_v = 5\%$  .

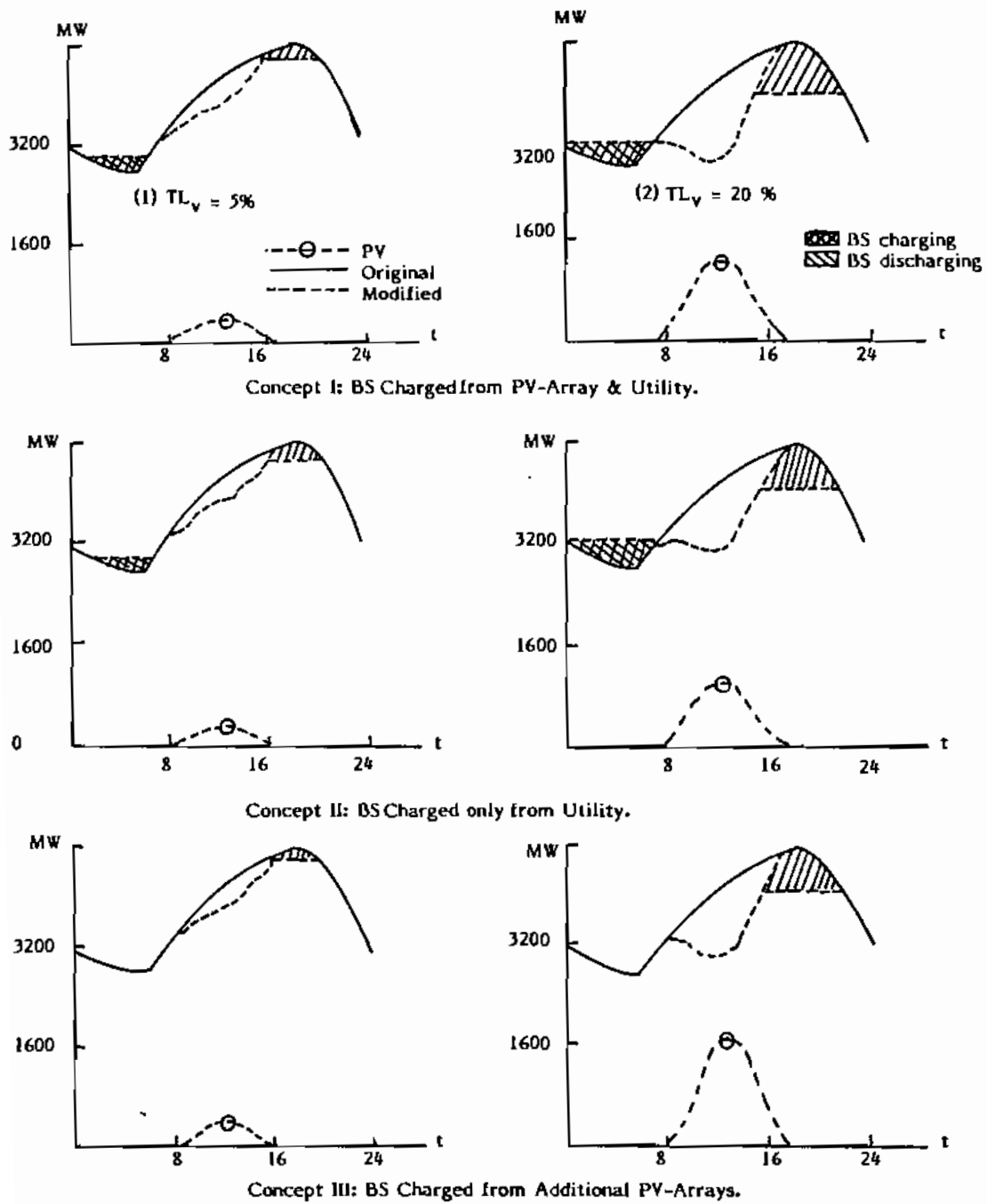

Fig. 3-b PV and Original & Modified Average Daily Conventional Generation Curves Applying the Proposed Design Concepts I, II & III, (January, Winter).

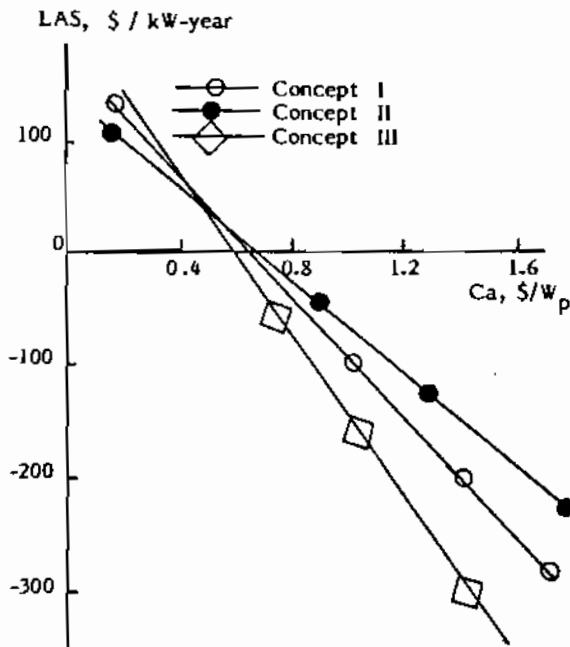

Fig. 4-1 ( $C_{fg} = 0.084$  &  $C_{fs} = 0.0376$  \$ / kWh)

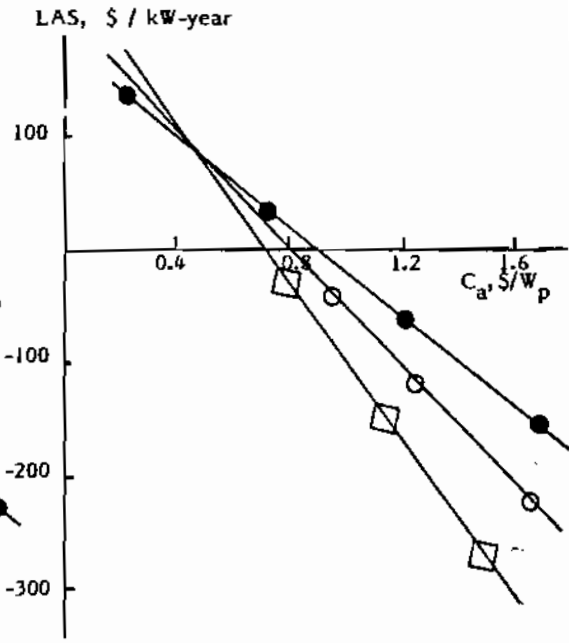

Fig. 4-2 ( $C_{fg} = 0.132$  &  $C_{fs} = 0.0376$  \$/kWh)

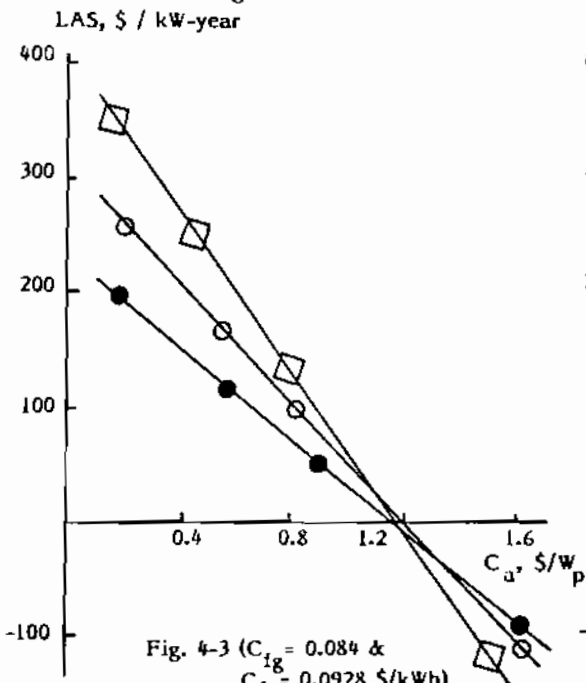

Fig. 4-3 ( $C_{fg} = 0.084$  &  $C_{fs} = 0.0928$  \$/kWh)

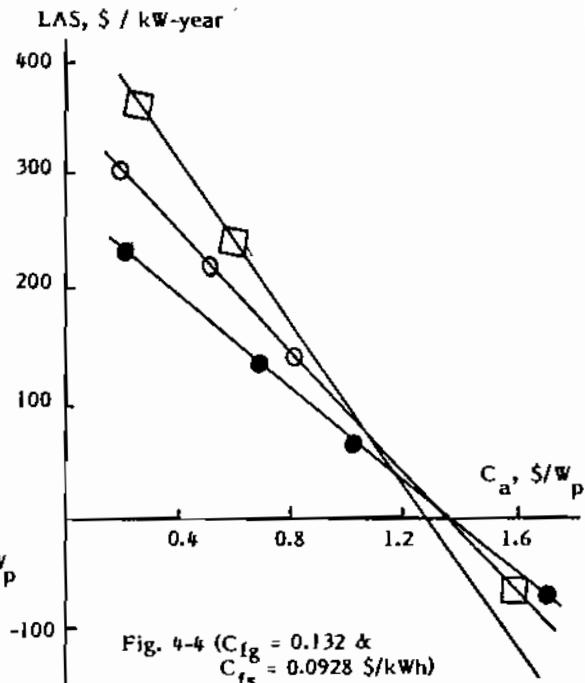

Fig. 4-4 ( $C_{fg} = 0.132$  &  $C_{fs} = 0.0928$  \$/kWh)

Fig. 4. Variation of the levelized annual savings with the price of the solar cells for various values of gas and steam turbines fuel prices, ( $C_b = 50$  \$/kWh,  $C_p = 0.5$  \$/W).



one for the price under consideration is then illustrated. Thus, the price of the cells determines the best design concept applied to have a sensible saving.

The slope and consequently the amount of savings, appreciably depends on the fuel prices of both types. Four prices of gas and steam turbine fuels are taken for investigation, and the results are shown in Figs. 4.1, 4.2, 4.3 & 4.4.

The intersections of such lines with the  $c_a$ -axis assign the cells prices at which no saving has been obtained on using PV-array and battery for our goals. It is expected to have different cells prices or points of intersection depending on the design concept applied. These items are summarized in Table-4 which incorporates also conditions of having largest annual savings.

Table.4. The cell prices for zero LAS and the largest value of LAS at  $c_b = 50$  \$/kWh,  $c_p = 0.5$  \$/W and different fuel prices

| fuel price,<br>\$/kWh                         | $c_{fs1} = 0.0376$ |              |                |                   |              |                | $c_{fs2} = 0.0928$ |         |                |                   |              |                |
|---|--------------------|--------------|----------------|-------------------|--------------|----------------|--------------------|---------|----------------|-------------------|--------------|----------------|
|   | $c_{fg1} = 0.084$  |              |                | $c_{fg2} = 0.132$ |              |                | $c_{fg1} = 0.084$  |         |                | $c_{fg2} = 0.132$ |              |                |
| D.conc.<br>Item                               | I                  | II           | III            | I                 | II           | III            | I                  | II      | III            | I                 | II           | III            |
| $LAS_0$ at $c_a$<br>of \$/W <sub>p</sub>      | 0.66               | <u>0.696</u> | 0.599          | 0.825             | <u>0.911</u> | 0.721          | <u>1.191</u>       | 1.144   | 1.154          | 1.356             | <u>1.360</u> | 1.276          |
| $LAS_M$ = at<br>$c_a = 0.3$ \$/W <sub>p</sub> | 96.707             | 81.404       | <u>108.170</u> | 140.918           | 125.615      | <u>152.381</u> | 239.184            | 173.485 | <u>309.017</u> | 283.394           | 217.696      | <u>353.223</u> |

From Table (4), zero levelized annual savings  $LAS_0$  can be achieved for any of the applied design concepts but at different SCA prices. The nearest SCA price to the present one is determined and underlined. Design concept II yields this price, in most cases studied, depending on the fuel prices. On other hand, with SCA price of  $0.3$  \$/W<sub>p</sub>, the application of the design concept III results in the largest annual savings ( $LAS_M$ ) compared with others. The value of these savings would also be underlined achieved for  $C_a = 0.3$  \$/W<sub>p</sub> with other concepts.

On other hand, Fig.5 depicts the same behaviours but with the battery (15 & 50 \$/kWh) and power conditioner (0.02 & 0.5 \$/w) costs as parameters. Least fuel costs are assumed to be fixed for their types. As can seen in this Figure, linear relationships are also attained as in Fig.4. Their slopes and accordingly points of intersection with  $C_a$ -axis differ dependent on the design concept followed.

Table (5) tabulates the cell prices necessitated to have zero and largest levelized annual savings for several conditions.

Similar conclusions to those of Table (4) can be drawn out of Table (5) but with the battery and power conditioner prices as a parameter.

For a constant penetration level of 5%, a mathematical model has been developed to express the levelized annual savings in \$/kW-year as a function of the PV-hardware and fuel prices. Its excellent validity stems from its high accuracy since the error does not exceed than  $\pm 0.1\%$ . Its coefficients differ only according to the design concept as given below :

Following Concept I

$$LAS_1 = -268.3 c_a - 0.402 c_b - 77.3 c_p + 2581.1 c_{fs} + 921.1 c_{fg} + 61.5$$

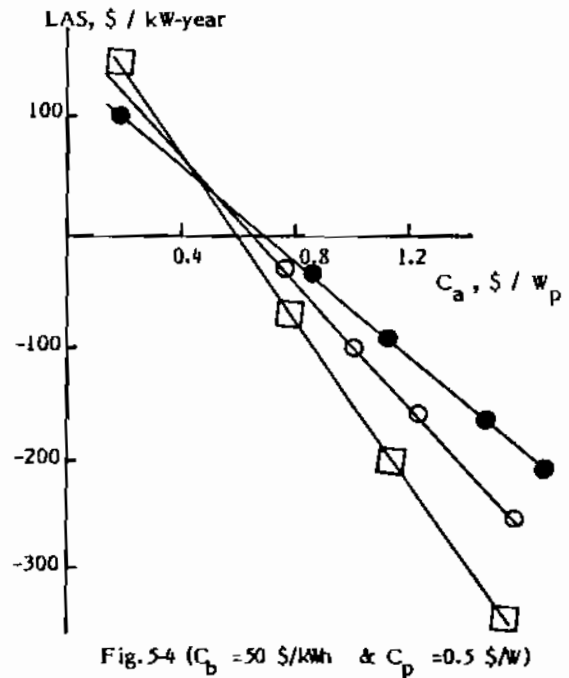
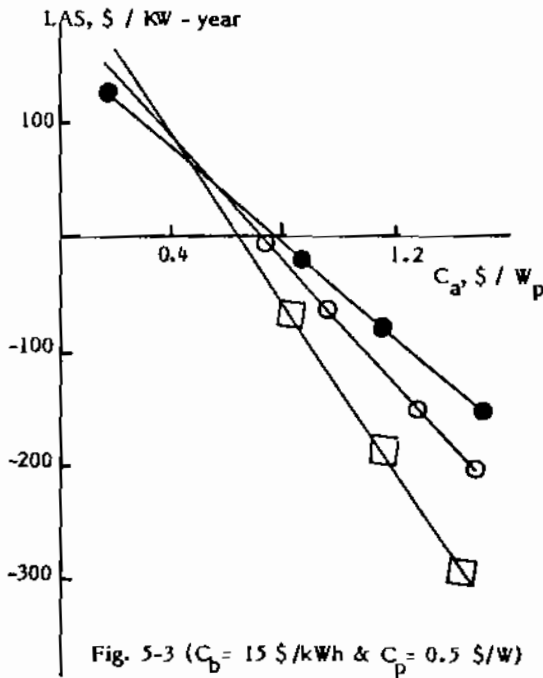
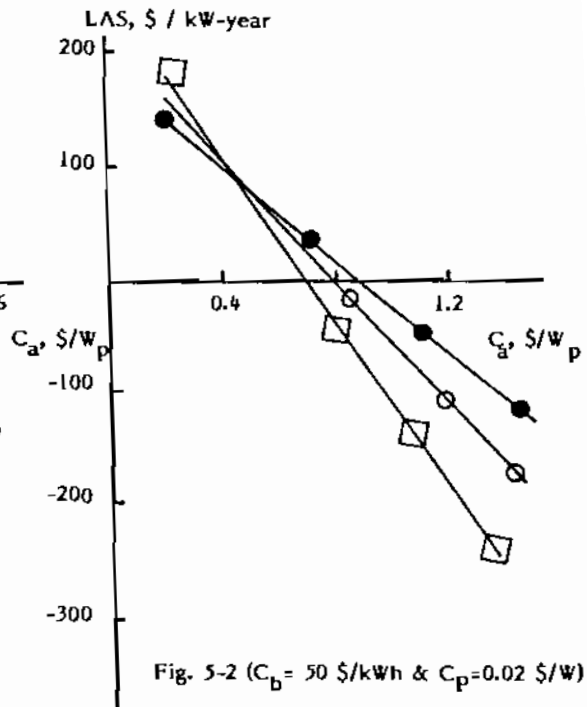
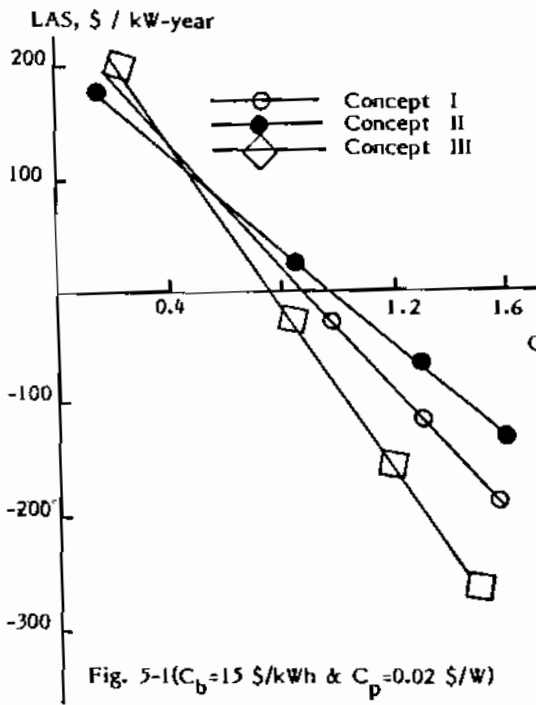

Fig.5 Variation of the levelized annual savings with the price of the solar cells for various values of battery and power conditioner prices, ( $C_{fg} = 0.084$  ,  $C_{fs} = 0.0376 \text{ \$/kWh}$ ).

Concept II

$$LAS_{II} = - 205.45 c_a - 0402 c_b - 77.3 c_p + 1668.1 c_{fs} + 921.1 c_{fg} + 61.7$$

Concept III

$$LAS_{III} = - 361.78 c_a - 0.402 c_b - 77.3 c_p + 3638.5 c_{fs} + 921.1 c_{fg} + 61.3$$

Table-5 The cell prices for zero LAS and the largest value of LAS at  $c_{fg} = 0.084$ ,  $c_{fs} = 0.0376$  and different battery storage and power conditioner prices.

| PC price \$/W<br>BS price \$/kWh<br>D-concept<br>Items | $c_{p1} = 0.02$ |              |                |               |              |                | $c_{p2} = 0.5$ |              |                |               |              |                |
|--|-----------------|--------------|----------------|---------------|--------------|----------------|----------------|--------------|----------------|---------------|--------------|----------------|
|  | $c_{b1} = 15$   |              |                | $c_{b2} = 50$ |              |                | $c_{b1} = 15$  |              |                | $c_{b2} = 50$ |              |                |
|  | I               | II           | III            | I             | II           | III            | I              | II           | III            | I             | II           | III            |
| $LAS_o$ at $c_a$ of<br>\$/W <sub>p</sub>               | 0.851           | <u>0.945</u> | 0.741          | 0.799         | <u>0.877</u> | 0.702          | 0.713          | <u>0.765</u> | 0.638          | 0.660         | <u>0.696</u> | 0.599          |
| $LAS_M =$ at<br>$c_a = 0.3$ \$/W <sub>p</sub>          | 147.903         | 132.599      | <u>159.365</u> | 133.828       | 118.525      | <u>145.290</u> | 110.782        | 92.479       | <u>122.245</u> | 96.707        | 81.404       | <u>108.170</u> |

4.2.3 Composite Effect of Economic Parameters & PV-penetration Level on Annual Savings

With different penetration levels, the levelized annual savings are computed taking the fuel, battery and power conditioner prices as parameters. Two main groups of curves are obtained. In the first one, (Figs.6 & 7), the fuel prices are the parameters, while in the second group, (Figs.8 & 9), they are the battery and power conditioner prices. Figs.6 & 7 depict these behaviours against the penetration level. Slight variation of savings is noticeable despite of considerable increase in PV-penetration level. They vary according to the design concept.

With low fuel prices and 1.0 \$/W<sub>p</sub> for solar cells array, PV/BS system is more expensive than the ease of using the conventional units as shown in Figs. 6.1 & 6.2. On other hand, increasing the fuel costs as demonstrated in Figs. 6.3 & 6.4 makes the PV/BS aggregation more economic and preferable to be used for peak shaving and load leveling. In general, the amount of savings depends on the design concept applied and the fuel, battery and power conditioner prices. Fig.7 reveals the same curves but with low PV hardware prices (0.3 \$/W<sub>p</sub>, 15 \$/kWh & 0.02 \$/W for SCA, battery and power conditioner respectively). They demonstrate sensible annual savings which would be higher on increasing the fuel prices. Figs. 8 & 9 depict the required composite effect with the hardware prices as a parameter. As shown in Fig. 8, there are no savings with low fuel prices and  $c_a = 1.0$  \$/W<sub>p</sub> although the battery and power conditioner prices would be varied. However, with higher prices of fuel while that of SCA of 0.3 \$/W<sub>p</sub> [12], there will be remarkable annual savings up to 400.317 \$/kW-year as displayed in Fig.10. Also, as can seen in previous figures (Figs. 6 & 7), the same behaviour would be demonstrated in the present ones, that is, the attainable savings have slightly been reduced on increasing the level of penetration.

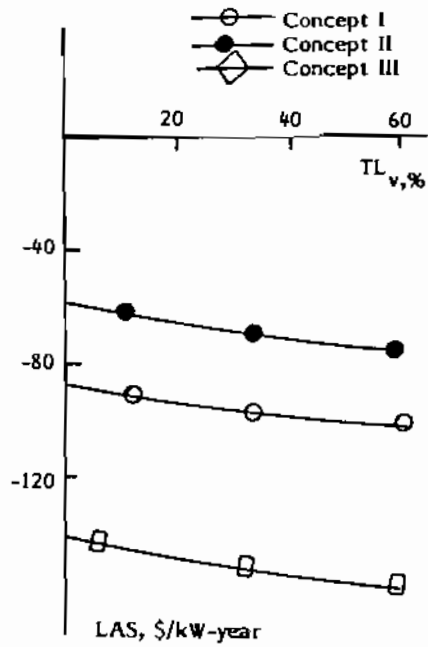

Fig. 6-1 ( $C_{fg}=0.084, C_{fs}=0.0376$  \$/kWh)

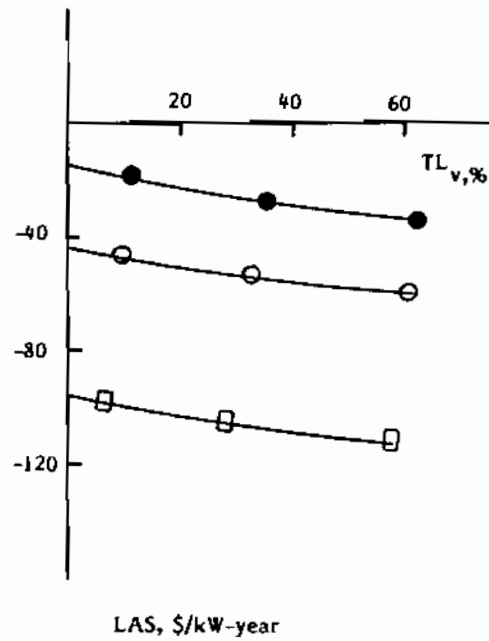

Fig. 6-2 ( $C_{fg}=0.132, C_{fs}=0.0376$  \$/kWh)

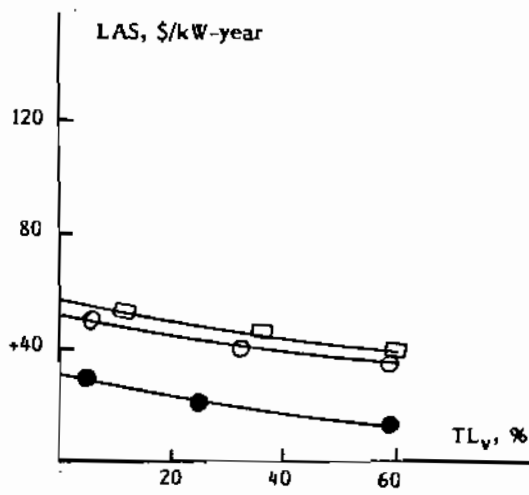

Fig. 6-3 ( $C_{fg}=0.084, C_{fs}=0.0928$  \$/kWh)

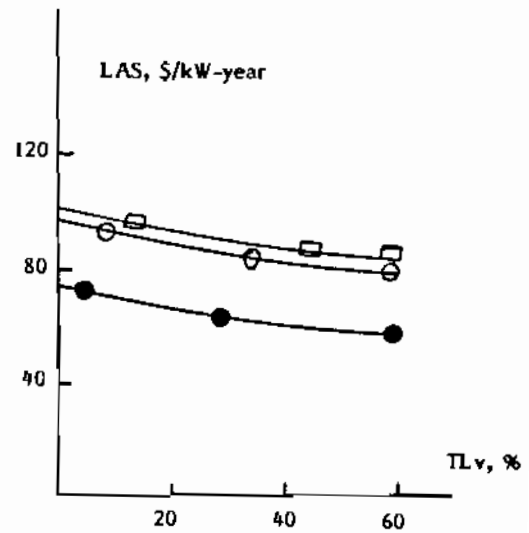

Fig. 6-4 ( $C_{fg}=0.132, C_{fs}=0.0928$  \$/kWh)

Fig. 6 Effect of the percentage penetration levels on the levelized annual savings for the different concepts, ( $C_a = 1$  \$/W,  $C_b = 50$  \$/kWh and  $C_p = 0.5$  \$/W).

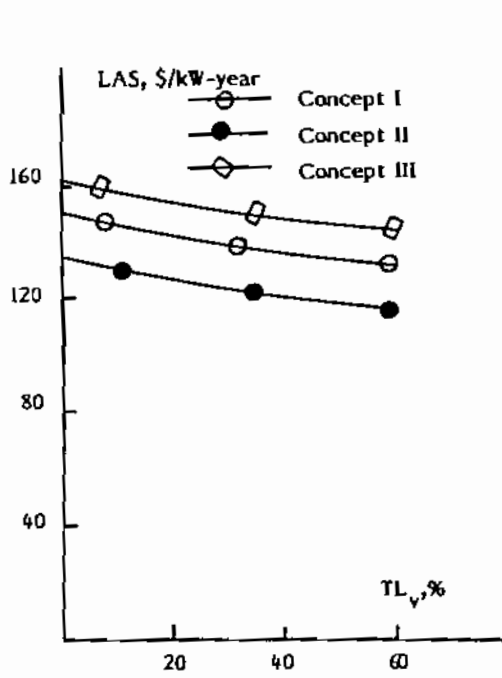

Fig. 7-1 ( $C_{fg} = 0.084$ ,  $C_{fs} = 0.0376$  \$/kWh)

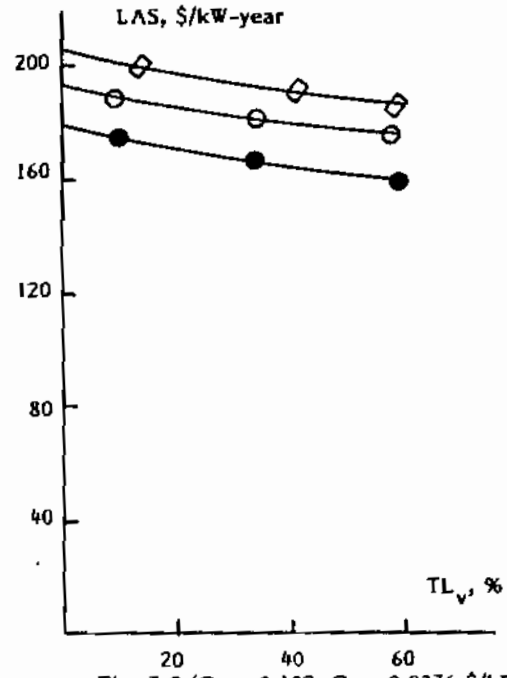

Fig. 7-2 ( $C_{fg} = 0.132$ ,  $C_{fs} = 0.0376$  \$/kWh)

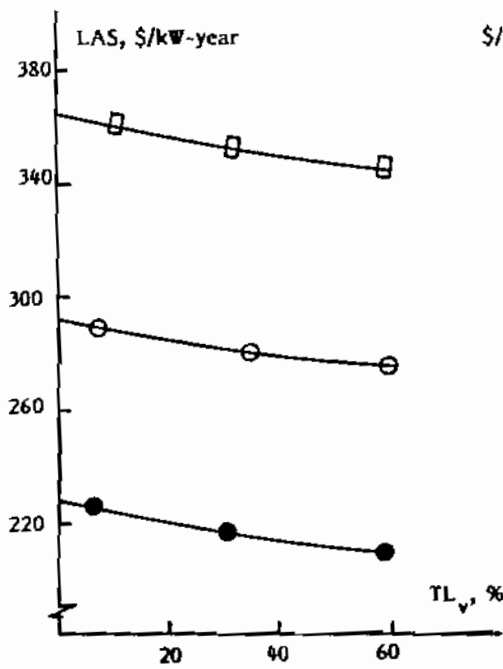

Fig. 7-3 ( $C_{fg} = 0.084$ ,  $C_{fs} = 0.0928$  \$/kWh)

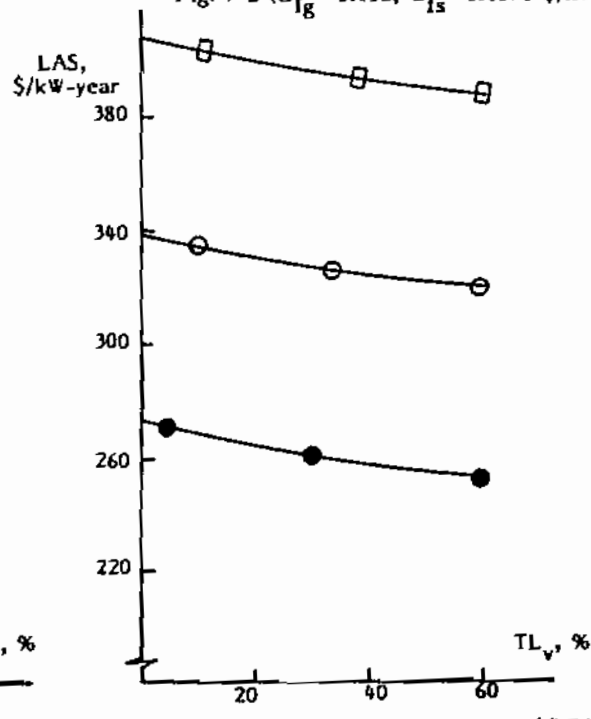

Fig. 7-4 ( $C_{fg} = 0.132$ ,  $C_{fs} = 0.0928$  \$/kWh)

Fig. 7 Effect of the percentage penetration levels on the levelized annual savings for the different concepts, ( $C_a = 0.3$  \$/W<sub>p</sub>,  $C_b = 15$  \$/kWh &  $C_p = 0.02$  \$/W).

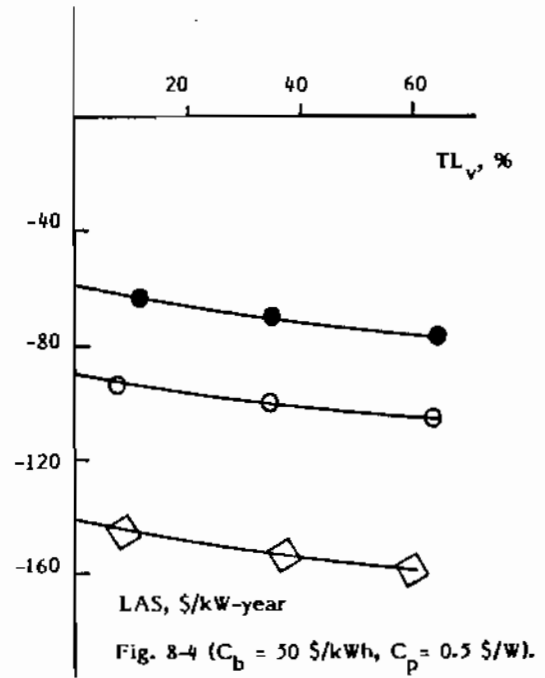
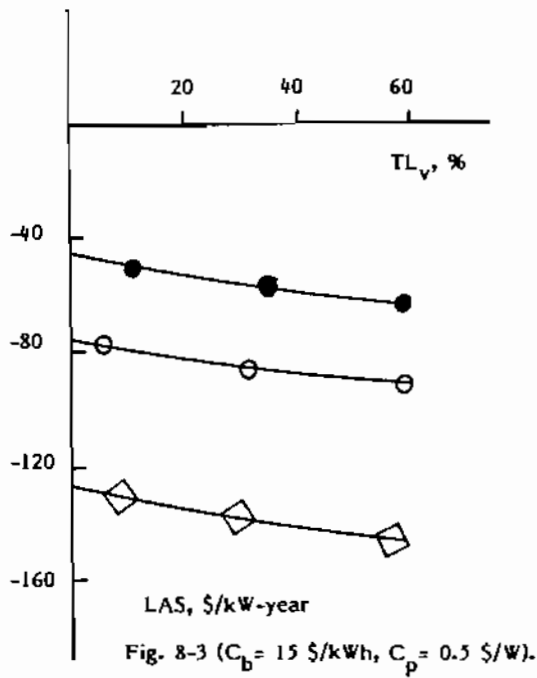
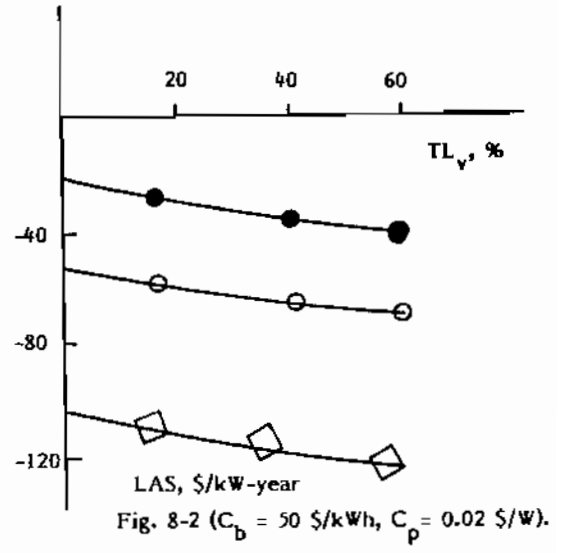
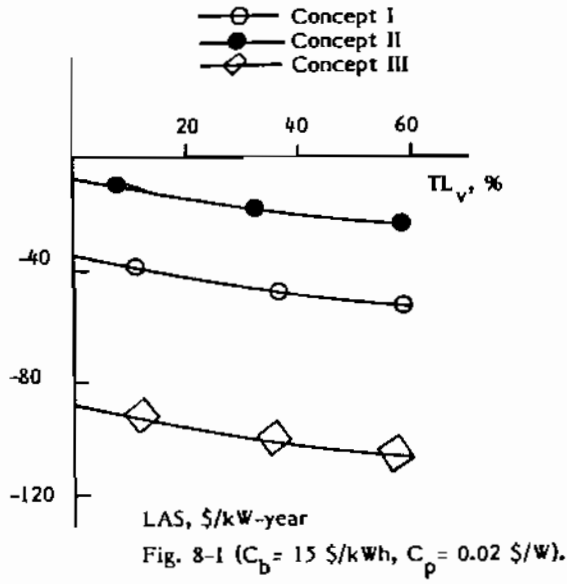

Fig. 8 Effect of the percentage penetration levels on the levelized annual savings for the different concepts, ( $C_a = 1$  \$/W<sub>p</sub>,  $C_{fg} = 0.084$  and  $C_{fs} = 0.0376$  \$/kWh).

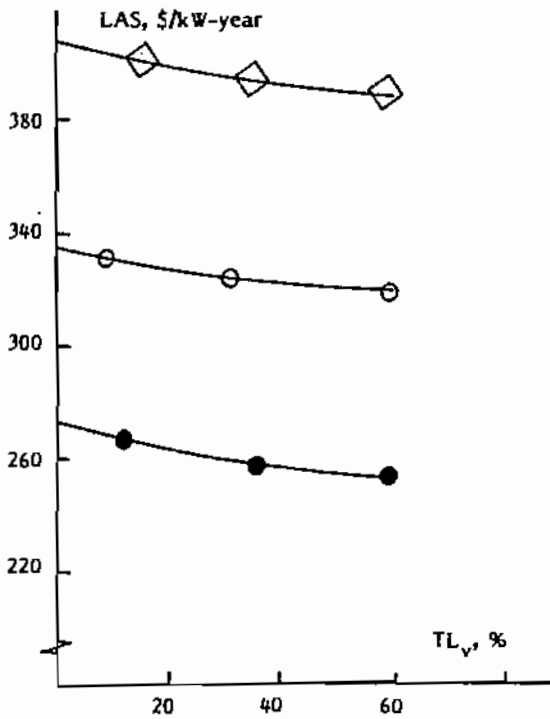

Fig. 9-1 ( $C_b = 15$  \$/kWh,  $C_p = 0.02$  \$/W).

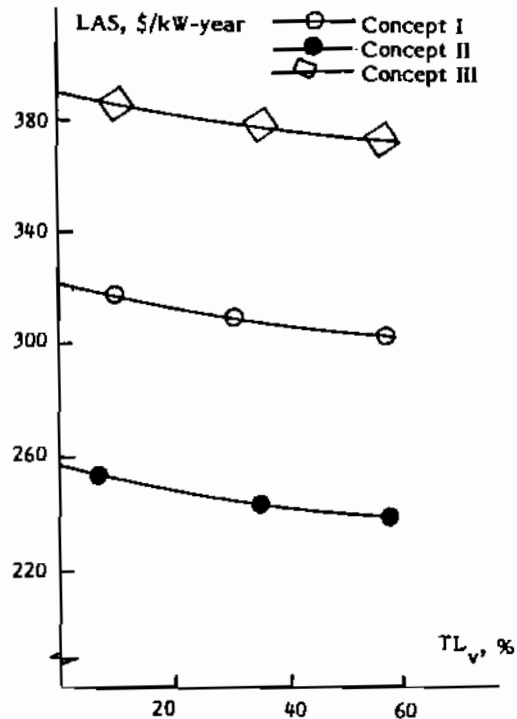

Fig. 9-2 ( $C_b = 50$  \$/kWh,  $C_p = 0.02$  \$/W).

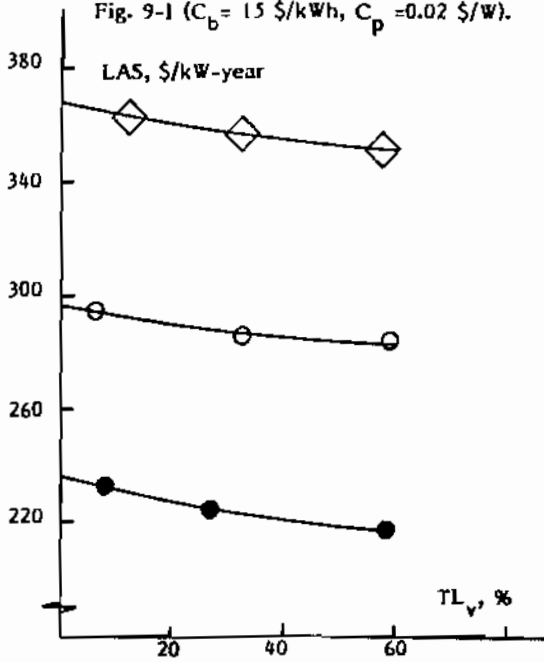

Fig. 9-3 ( $C_b = 15$  \$/kWh,  $C_p = 0.5$  \$/W).

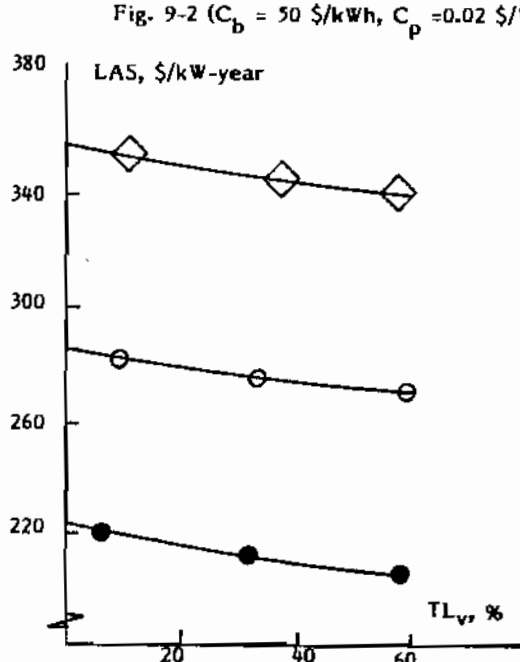

Fig. 9-4 ( $C_b = 50$  \$/kWh,  $C_p = 0.5$  \$/W).

Fig. 9 Effect of the percentage penetration levels on the levelized annual savings for the different concepts, ( $C_a = 0.3$  \$/W,  $C_{IG} = 0.132$ ,  $C_{IS} = 0.0928$  \$/kWh).

A general model is thus deduced expressing and giving directly LAS for any PV-penetration level in addition to any PVPS-components and fuel prices.

Again the model coefficients depends only on the applied design concept resulting in :

Concept I

$$LAS_I = - 268.3 c_a - 0.402 c_b - 77.3 c_p + 2581.1 c_{fs} + 921.1 c_{fg} + 13.31 TL_v^2 - 36.25 TL_v + 62.018$$

Concept II

$$LAS_{II} = - 205.45 c_a - 0.402 c_b - 77.3 c_p + 1668.1 c_{fs} + 921.1 c_{fg} + 33.03 TL_v^2 - 51.418 TL_v + 59.673$$

Concept III

$$LAS_{III} = - 361.78 c_a - 0.402 c_b - 77.3 c_p + 3638.5 c_{fs} + 921.1 c_{fg} + 33.8 TL_v^2 - 52.0 TL_v + 63.531$$

5. CONCLUSION

The outcome of this paper, concerning the issue of optimizing the operation of PV/BS aggregation with the utility grid to shaving the peak and leveling the load, can be stated in the following way :

- 1- An accurate solution algorithm has been proposed and applied using actual and continuous twelve solar radiation profiles for a calendar year. The corresponding daily PV maximum output power curves can then be drawn which have been used throughout the design process.
- 2- Three PV and BS design concepts are suggested and applied for different PV-penetration levels and PV-hardware and fuel prices.
- 3- A comparative economic study has, thus, been performed and analyzed to differentiate between the cases of either using the combustion turbines or the PV/BS combination under several economic and PV-penetration levels. The levelized annual savings (LAS) in \$/kW-year is the index upon which this comparison depends. The analysis of these results leads to the following conclusions :
  - 3.1 The LAS has a linear behaviour versus the SCA price with the fuel costs ( $c_{fg} = 0.084 - 0.132$  &  $c_{fs} = 0.0376 - 0.0928$  \$/kWh) as a parameter taking a constant PV-penetration level. Their slopes and consequently the amount of savings appreciably depends on the fuel costs. The SCA-prices at which no savings have been obtained are deduced as can be seen in Table (4) which incorporates also the largest annual savings (at  $c_a = 0.3$  \$/W<sub>p</sub>).
  - 3.2 Fig.5 depicts the same behaviour but with the prices of the battery (15-50 \$/kWh) and the power conditioner (0.02-0.5 \$/W<sub>p</sub>) as a parameter and Table (5) tabulates the cell prices necessitated to have zero and largest LAS (0.599-0.851 \$/W<sub>p</sub> & 0.3 \$/W<sub>p</sub> to have  $LAS_M = \$1.404 - 159.365$  \$/kW-year respectively).



- 3.3 Figs. 6,7,8 & 9 display the composite effect of the hardware prices of PV system and that of the fuel with the PV-penetration level on LAS. The increase of the fuel costs ( $c_{fg} = 0.132$ ,  $c_{fs} = 0.0928$  instead of  $c_{fg} = 0.084$  &  $c_{fs} = 0.0376$  \$/kWh) makes the PV/BS aggregation more economic compared with the combustion turbines as displayed in Figs. 6.3&6.4. The amount of LAS depends on the design concept applied and the fuel, battery and power conditioner costs for a certain SCA prices. With  $c_p = 1.0$  \$/W<sub>p</sub> and low fuel prices ( $c_{fg} = 0.084$  &  $c_{fs} = 0.0376$  \$/kWh), the PV/BS system is expensive than the case of using the conventional units. However, with hopeful SCA price of 0.3 \$/W<sub>p</sub>, 15 \$/kWh for the battery and 0.02 \$/W for the power conditioner, sensible annual savings have been attained (161.259 \$/kW-year at this low prices of fuel) which would be higher on increasing the fuel costs.
- 4- (LAS-PV-penetration level) behaviour demonstrates that a slight variation of savings is remarkable despite of considerable increase in PV-penetration level. It varies also according to the design concept.

#### REFERENCES

- [1] C.R. Chowaniec, J.L.Maitlen, H.S.Kirschbaum and W.Feduska, "Energy Storage Operation of Combined Photovoltaic/Battery Plants in Utility Networks", 13th IEEE PV Specialists Conference, 1978.
- [2] W.S. Ku, N.E. Nour and T.M. Piascik, "Economic Evaluation of Photovoltaic Generation Application in Large Electric Utility System", IEEE Transaction on Power Apparatus and Systems, Vol. PAS-132, No.8 August 1983.
- [3] Glenn Zorpette, "High-tech Batteries for Power Utilities", IEEE Spectrum, Oct.1984
- [4] Zia A. Yamayee and John Peschon, "Utility Integration Issue of Residential PV-Systems", IEEE Transactions on Power Apparatus and Systems, Vol.PAS-100, No.5, May 1981
- [5] John W. Mitchell, "Energy Engineering", book, John Wiley & Sons, 1983
- [6] H.L. Macomber, J.B. Ruzek, F.A. Castello and staff of bird Engineering Research Associates, "Photovoltaic Stand-Alone Systems : Preliminary Engineering Design", Handbook prepared for NASA, LeRC, Contract DEN 3-195, August 1981.
- [7] H. EL-Shaar and T.EL-Tablawy, "Conserving the Operation of Gas Stations", conserving the production and utilization of electrical energy meeting, Cairo, Jan.1984.
- [8] H.EL-Shaar and F.Ghalab, "Economic Operation of Egypton Electrical Grid", conserving the production and utilization of electrical energy meeting, Cairo, Jan.1984.
- [9] Ministry of Petroleum , "Conservation of Energy Support", conserving the production and utilization of electrical energy meeting, Cairo, Jan.1984.
- [10] D.L. Pulfrey, "Photovoltaic Power Generation ", book, Van Nostrand Reinhold Company, 1978.
- [11] Stanly L.Leonard "Photovoltaic Power Generation for Utilities : The Implications of Some Recent Projects & Design Studies", IEEE Transactions on Energy Conversion, Vol. Ec-1, No.2, June 1986.

- [12] Taylor Moore, "Pioneering the Solid State Power Plant", IEEE Power Engineering Review; July 1986.
- [13] A.J. Stranix and A.H. Firester, "Conceptual Design of a 50 Mw Central Station PV-Power Plant.", IEEE Transactions on Power Apparatus and Systems, Vol. PAS 102, No.9 Sep. 1983
- [14] Connor, T.J., Bogen, A.H., "Study of The Value of a PV-Central Station to a Sunbelt Utility", Aerospace Report No. ART-81 (7880)-1, April 1981
- [15] Alec Bulawka, Stan Krauthamer and Radhe Das, "Power Conditioning Subsystems for Photovoltaic Central-Station Power Plants: State-of-the Art and Advanced Technology", IEEE Transactions on Energy Conversion, Vol. EC-1 No.1, March 1986.

APPENDIX

1. PV-Array, Battery & Power Conditioner Specifications

| Price \$/w <sub>p</sub> | Array type                                | Price \$/kWh | Battery type  | Price \$/w <sub>p</sub> | Power conditioner type            |
|-------------------------|---|--------------|---------------|-------------------------|-----------------------------------|
| 1.5                     | Single crystal Silicon cell               | 50           | Lead Acid     | 0.5                     | Pulse-Width Modulation .          |
| 1.0                     | Flat-plate module of crystalline silicon. | 35           | Lead Acid     | 0.35                    | Pulse-Width Modulation.           |
| 0.5                     | Amorphous thin film.                      | 15           | Zinc Chlorine | 0.2                     | dc/dc converter for power control |
| 0.3                     | A. Si Monolithic                          |              |               | 0.02                    | Pulse-Width Modulation.           |

2. Design and Economic Factors

| Factor   | $\eta_a$         | $\eta_b$          | $\eta_p$          | $\eta_R$         | DOD               | V.F               | F.S              | d                 | $I_1$            | $I_2$             | T (years)       | m              |
|----------|------------------|-------------------|-------------------|------------------|-------------------|-------------------|------------------|-------------------|------------------|-------------------|-----------------|----------------|
| Per Unit | 0.1 <sup>g</sup> | 0.85 <sup>a</sup> | 0.95 <sup>g</sup> | 0.9 <sup>e</sup> | 0.95 <sup>a</sup> | 0.85 <sup>a</sup> | 1.2 <sup>a</sup> | 0.12 <sup>b</sup> | 0.1 <sup>d</sup> | 0.08 <sup>a</sup> | 20 <sup>a</sup> | 1 <sup>a</sup> |

3. Photovoltaic Array, Battery and Power Conditioner Prices

| Item  | $C_a, \$ / w_p$   | $C_b, \$ / kWh$                                     | $C_p, \$ / w$   |
|-------|---|---|---|
| Price | 0.3 <sup>g</sup> , 0.5 <sup>e</sup> , 1.0 <sup>j</sup> , 1.5 <sup>h</sup> | 15 <sup>e</sup> , 35 <sup>a</sup> , 50 <sup>e</sup> | 0.02 <sup>i</sup> , 0.2 <sup>f</sup> , 0.35 <sup>e</sup> , 0.5 <sup>i</sup> |

4. Gas and Steam Fuel Prices

| Item  | $C_{fg}, \$ / kWh$  | $C_{fs}, \$ / kWh$  |
|-------|---|---|
| Price | 0.084 <sup>c</sup> , 0.096 <sup>c</sup> , 0.108 <sup>c</sup> , 0.132 <sup>c</sup> | 0.0376 <sup>c</sup> , 0.0576 <sup>c</sup> , 0.0736 <sup>c</sup> , 0.0928 <sup>c</sup> |

5. Conventional Generation Unit Costs

| Item  | DC <sub>g</sub> , \$ / kw | DC <sub>s</sub> , \$ / kWh | AOC <sub>g</sub> , \$ / kWh-year | AOC <sub>s</sub> , \$ / kWh-year |
|-------|---------------------------|----------------------------|----------------------------------|----------------------------------|
| Price | 320 <sup>b</sup>          | 625 <sup>b</sup>           | 14.4 <sup>b</sup>                | 7.2 <sup>b</sup>                 |

a : Ref. [6] , b : Ref. [7] , c : Ref. [8] , d : Ref. [9] , e : Ref.[10] , f : Ref. [11]  
 j : Ref. [12] , g : Ref. [13] , h : Ref. [14] , i : Ref. [15]

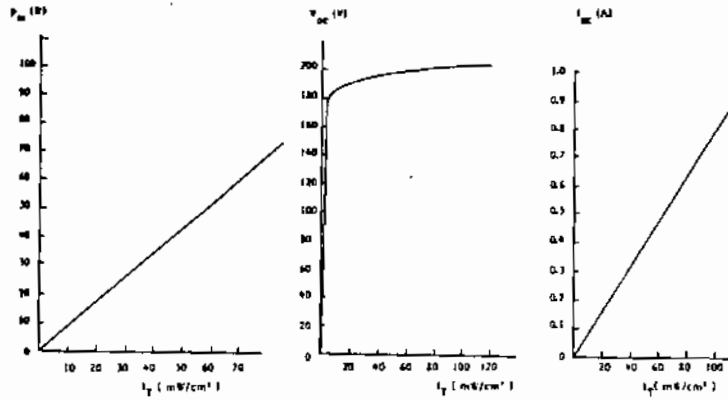

Fig. 10: Change of Maximum Power, Open Circuit Voltage & Short Circuit Current of PV-Module against Solar Radiation Intensity.

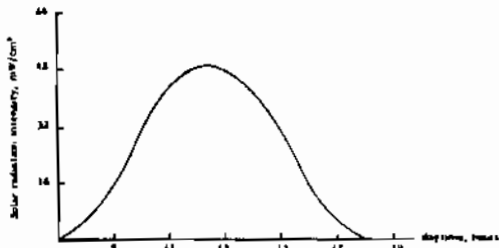

Fig. 12-a Actual daily solar radiation intensity pattern of winter season (January) recorded at El-Mansoura city, EGYPT.

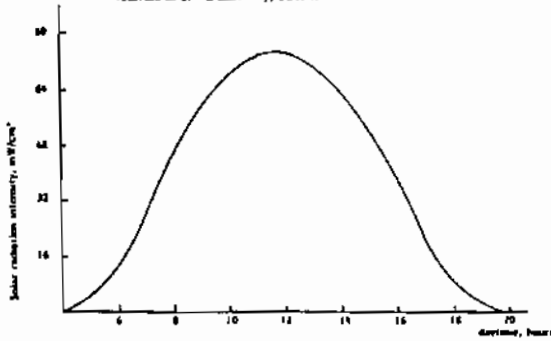

Fig. 12-b Actual daily solar radiation intensity pattern of summer season (July) recorded at El-Mansoura city, EGYPT.

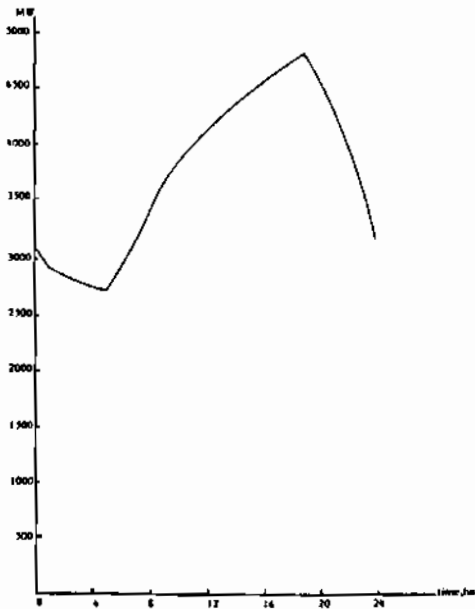

Fig. 11 Average Daily Conventional Generation Curve.