

5-24-2021

## Design and Implementation of a Stabilizing Network for Reluctance Motors.

S. Osheba

*Electrical Engineering Department., Faculty of Engineering., Menoufia University., Shebin El-Kom., Egypt.*

F. Abdel Kader

*Electrical Power Engineering., Faculty of Engineering., Suez Canal University., Port Said., Egypt.*

Follow this and additional works at: <https://mej.researchcommons.org/home>

---

### Recommended Citation

Osheba, S. and Abdel Kader, F. (2021) "Design and Implementation of a Stabilizing Network for Reluctance Motors.," *Mansoura Engineering Journal*: Vol. 14 : Iss. 1 , Article 8.

Available at: <https://doi.org/10.21608/bfemu.2021.171830>

This Original Study is brought to you for free and open access by Mansoura Engineering Journal. It has been accepted for inclusion in Mansoura Engineering Journal by an authorized editor of Mansoura Engineering Journal. For more information, please contact [mej@mans.edu.eg](mailto:mej@mans.edu.eg).

DESIGN AND IMPLEMENTATION OF A STABILIZING NETWORK FOR  
RELUCTANCE MOTORS

تصميم واستخدام دائرة موازنة لمحرك المعاوقة

F. M. Abdel Kader  
Faculty of Eng.  
Suez Canal University  
Port Said, EGYPT.S. M. Osheba  
Faculty of Eng.  
Menoufia University  
Shebin El-Kom, EGYPT.

يختص هذا البحث بتصميم واستخدام دائرة موازنة لاصداد الترددات المنخفضة التي تظهر في هذا المحرك وتنبسب تأرجح المصو الدائر حول سرعة التزامن مما يؤدي الى سوء اداء او ضروحة عن حدود الاتزان . في البداية تم تحديد نوع و عناصر دائرة الموازنة ومناسبة المتغيرات الممكن استخدامها كإشارة دخل لهذة الدائرة ووجد ان العرصة مناسبة كمتبر موازنة تصف ظروف تشغيل هذا المحرك .

لتصميم عناصر هذة الدائرة تم بناء نموذج حتى لهذا المحرك في المحاور الفراغية . . . . . واستخدم للتحليل في ازالة العناصر المعيرة للنظام لتحديد القيم المناسبة لعناصر الدائرة ، وتم اختيار الثوابت التي تعطين اقص احماد للتأرجحات حيث ان اختبار هذة العناصر يؤثر مباشرة في اداء المحرك ويؤدي الاختيار غير المناسب الى خروج المحرك عن اتزانه . ولتحقق من النتائج تم حساب عزوم الاضداد الذي يضيف الموازن الجديد باستخدام نظرية عزم الاضداد وعزم المضاد ووجد اتفاق بين الطريقتين

لتقييم النتائج ، تم عمل برنامج محاكاة متكامل للمحرك على الحاسب الرقمي ، وعند مقارنة اداء المحرك عمب سرعة لاضواع مختلفة من الاضطرابات وجد تحسن كبير في الاداء عند استخدام الموازن ، كما ان النتائج توضح عدم وجود أي تأخير عكس على سده الحركة في وجود الموازن مما يسبب جعل الموازن جزءا دائما من دائرة لرميلا الخارحية . يضاف الى الامة التطبيقية لهذا البحث انه قدم طريقة لتصين اداء المحرك باستخدام دائرة كهربية بسيطة .

## Abstract

This paper presents a method for stabilizing the low-frequency oscillations in reluctance motors. This method is based on modulating the input voltage by a feedback signal. This signal is obtained by using a speed feed back through a lead/lag compensating network. The parameters of this network are designed using an eigenvalues shift technique and the values which give maximum damping were determined. The obtained results illustrate a significant increase in damping and indicates that substantial improvement in reluctance motor performance can be achieved by using a simple electric circuit.

## 1. INTRODUCTION

From among the electric drive systems, reluctance motors exhibit a relatively poor dynamic performance. This is indicated by a limited stable operating region and small-amplitude low-frequency oscillations about the synchronous speed. Dynamic instability has been a subject of growing interest since the early 70's and a proper understanding of this instability, as affected by design parameters, has been reported [1-4]. However, problems associated with the low-frequency oscillations are still, to the author's knowledge, unsolved. These oscillations deteriorate the dynamic performance that follows small disturbances and, under

conditions, they build-up in magnitude, leading to motor instability. These problems, in the authors point of view, are limiting the wide spread application of reluctance motors.

To overcome this problem, positive damping must be added to the motor to compensate for its low inherent damping. The additional damping may be introduced either internally, via a proper design of the motor parameters, or externally, by using a suitable control strategy. Lawrenson et AL indicated that overall internal damping is affected by some of the motor parameters [3]. The problem of how to increase the internal damping has been recently investigated using the damping and synchronizing torque technique. It has been concluded [5,6] that the internal damping can be substantially improved by a suitable choice of both the q-axis resistance and the axes reactances ratio. The external additional damping was firstly discussed by Krause who suggested methods for stabilizing reluctance motors, based on a proportional feedback [7]. Alternatively, this paper examines the introduction of additional external damping using both proportional and integral feedback.

The object of this paper is to design and test a compensating network to stabilize the low-frequency oscillations in reluctance motors. This is achieved by using a lead/lag compensator and a speed feedback signal. The speed stabilizer parameters have been considered and their optimum values are obtained using an eigenvalues shift technique. The effects of this stabilizer on dynamic performance is investigated. Results illustrate a substantial improvement in both motor damping and overall performance using this approach. The obtained results are of interest to both users and designers due to the fact that the improved performance is achieved using a simple circuit.

## 2. STABILIZATION CONCEPT

Small amplitude and low-frequency oscillations often persist on the shaft of reluctance motors for a long period of time, limiting the stable region and deteriorating the motor performance. The basic function of the stabilizer is to add positive damping to these oscillations so that the dynamic performance is improved. To provide damping, the stabilizer must produce a component of electrical torque in phase with the speed variations. Also, the transfer function of the stabilizer must compensate for the motors' gain and phase characteristics. Moreover, the phase compensation of the stabilizer should cover the interested range of frequencies.

Stabilizing the low-frequency oscillations is a well known technique in synchronous machines [8-10]. Nevertheless, its application to reluctance motors is still uninvestigated. In asynchronous machines, the stabilizing signal is added to the exciter reference point, a matter that yields positive damping to compensate for deterioration in damping following disturbances [8,10]. In reluctance motors, the stabilizing signal is added to the input voltage which modulates the axes flux in a way that produces positive damping. The stabilizing network used in this investigation is shown in Fig.1. It consists of two time constants ( $T_1$  &  $T_2$ ) and a gain,  $G$ . This lead/lag network can be easily configured from a simple RLC circuit, with a suitable choice of the time constants and the gain [11]. The ratio of the time constant affects the range of stabilized frequencies and it generally depends on the machine type. In conventional synchronous machines this time-constant ratio is about 10 [10] and in

ing generators it reaches 50 [12]. In reluctance motors previous published values concerning the stabilizer and careful attention must be given to their choice. to the fact that an improper choice of stabilizer may lead to motor instability even from stable. In this work, these parameters are designed based on an shift technique, to predict those values which increase he frequency range of interest.

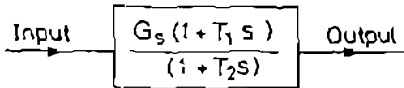

Fig. 1 Stabilizing Transfer Function

ING VARIABLES

ent accessibility, steady-state values and the ramping are generally, the measures to be considered for a specific variable as a stabilizer input signal. ilizing signals such as rotor speed, electrical torque ion can be used [9]. In reluctance motors, the ad changes require zero steady state value of the put signal. Although it gives good stabilization and o steady state value, the rotor acceleration is not because it is difficult to measure in practice. The m synchronous speed is used as a stabilizing signal satisfies the above mentioned measures. The es of this signal are investigated later.

OR REPRESENTATION

ally, transfer function and high-order polynomials are analysis of reluctance machines[2,4]. This, however, e simplifications which, in some cases, neglects rameters in the analysis of motor dynamical ]. Recently, a linear, time-invariant, state-space ined for reluctance motors which takes account of all parameters [13]. The nonlinear equations of polyphase tors are perturbed about an operating point, leading ing state space model in which the state vector is

$$\{ \psi_a, \psi_b, \psi_c, \psi_0 \} \quad 1$$

$$\{ U \} \quad 2$$

- the motor matrix;
- the input matrix;
- the state vector.
- the input voltage, measured from a reference point

The A matrix is the open loop matrix and the eigenvalues obtained using this matrix are used to assess the increase in damping due to some stabilizer parameters. To include the stabilizer in the above state space model, additional state variable  $X_s$  is introduced as shown in Fig.2, leading to the following equations :

$$\Delta X_s = \{G_s(1 - T_1/T_2) \cdot \Delta\omega - \Delta X_s\}/T_2 \quad 3$$

$$\Delta Y_s = \{G_s \cdot T_1/T_2\} \cdot \Delta\omega + \Delta X_s \quad 4$$

Equation 2 can be augmented to include Equation 3 by adding:

$$A(7,2) = G_s(1 - T_1/T_2) \quad , \quad A(7,7) = -1/T_2 \quad 5$$

The controlled input can also be modified to be:

$$\Delta u = (0 \ G_s \cdot T_1/T_2 \ 0 \ 0 \ 0 \ 0 \ 1) \cdot \underline{x} \quad 6$$

Eqn.6 can be simply written as:

$$\Delta u = [F] \cdot X \quad 7$$

Substituting from Eqn. 7 into Eqn. 2, the closed loop matrix can be obtained as:

$$\dot{X} = [A + B \cdot F] X \quad 8$$

$$= \lambda \cdot X \quad 9$$

Where  $\lambda$  is the closed loop matrix. The roots of this matrix represent the new motor roots.

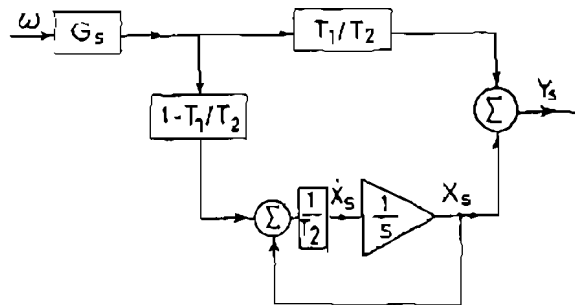

Fig. 2 State Representation Of Stabilizing Network

## 5. DESIGN ASPECTS

Normally, the stabilizer must improve the motor performance about the severe low-frequency mode. Therefore, the center of the network compensation range may be set to the hunting mode. This

frequency can be obtained, for the network in Fig.1, as [8]:

$$f_c = \frac{1}{2\pi\sqrt{T_1 T_2}} \quad \text{Hz} \quad 10$$

where the time constant ratio  $R (=T_1/T_2) > 1$

$$T_2 = \frac{1}{2\pi f_c \sqrt{R}} \quad \text{Hz} \quad 11$$

Substituting the hunting frequency, obtained from the open loop matrix Eqn.2, in Eqn.11, the time constants can be obtained. To illustrate the effects of stabilizer parameters on the motor dynamic performance, the eigenvalues of the closed-loop matrix, Eqn. 9, are obtained for different values of time constant ratio,  $R$ , and gain  $G_s$ . The loci of the dominant roots are shown in Fig.3. This result illustrates that, for a specific value of  $R$ , increasing  $G_s$  up to a certain value, increases motor damping and reduces the oscillation frequency. A further increase in  $G_s$  reduces motor damping. This result also illustrates that, for each time constant ratio there is a value of stabilizer gain at which maximum damping occurs as observed from Fig.4. Therefore, for each time constant ratio, the optimum stabilizer gain  $G_{s, opt}$  can be defined as the value which gives maximum damping. The results indicate that a decrease in the time constant ratio increases motor damping. However, the range of compensating frequencies is reduced as the time-constant ratio increases as shown in Fig. 5. Therefore, the choice of  $R$  is a compromise between increasing motor damping and decreasing the range of compensating frequencies. A value of  $R = 5.0$  has been found suitable for proper stabilization of reluctance motors. This time-constant ratio is within the practical range of compensating networks [11].

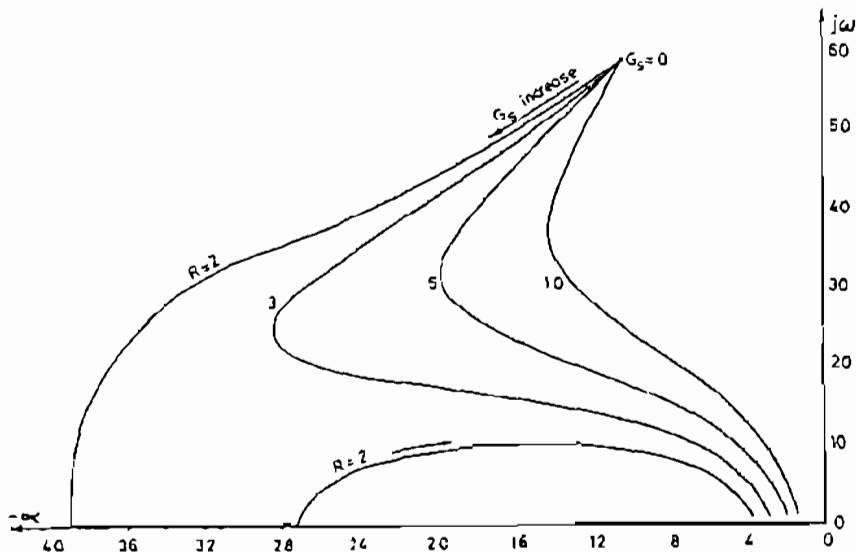

Fig.3 Effects of Stabilizer Gain on the Loci of Dominant Eigenvalues

## 6. COMPARISON OF EIGENVALUES

Table-1 shows a comparison between the eigenvalues of the reluctance motor with and without speed stabilizer. The above recommended parameters of the stabilizer were used. It is clear that the stabilizer shifts the roots towards the negative real axis, indicating an increase in damping and an improvement of the dynamic performance.

Table-1 : EFFECTS OF STABILIZER ON EIGENVALUES

Mode of Oscillations Motor Circuit	Eigenvalues	
	Without stabilizer	With stabilizer
Stator Circuit	- 467+j 110.0	-240.8+i424.5
Rotor Circuit	-10.6+j58.9	-19.7+j33.2
Damper Circuits	-85.4, -151.8	-65.20 , -44.4
Stabilizer Mode	0	-53.7

## 7. TECHNIQUE VERIFICATION

The above mentioned technique, used to choose the stabilizer parameters, is based on the eigenvalues analysis of linear motor equations. The object of this section is to evaluate and confirm the results using the time response analysis of nonlinear equations [6,10]. Following a load change on the motor shaft, the resulting electrical torque can be decomposed into damping and synchronizing torque components as follows :

$$\Delta T_e = K_{D0} \cdot \Delta \omega + K_{s0} \cdot \Delta \delta \quad 12$$

Where  $K_{D0}, K_{s0}$  are time-invariant coefficients of damping and synchronizing torque, respectively. The stabilizer must add a torque component in time phase with the rotor speed. This leads to the following equation:

$$\Delta T_e = (K_{D0} + K_{D1}) \cdot \Delta \omega + (K_{s0} + K_{s1}) \cdot \Delta \delta \quad 13$$

Where  $K_{D1}, K_{s1}$  are the increase in damping and synchronizing torques, respectively, due to the stabilizer action. Fig.6 illustrates the damping torque coefficient using the damping and synchronizing torque technique. It confirms the remarks explained in the above section, indicating that, for each time-constant ratio R, there is an optimum value of stabilizer gain at which maximum damping occurs. The time response of the speed deviation due to a step load disturbance is shown in Fig.7 for a reluctance motor without and with stabilizer at different values of R. It can be observed that the increase in motor damping, even with a higher value of R, about 400 % of the original motor damping, is sufficient to provide excellent motor performance following a load disturbance. Although higher values of R, increase the range of stabilizing frequencies, they are not recommended as the stabilizer becomes sensitive to system noise. Therefore, values of R = 5 and stabilizer gain below 0.05 are recommended to give good

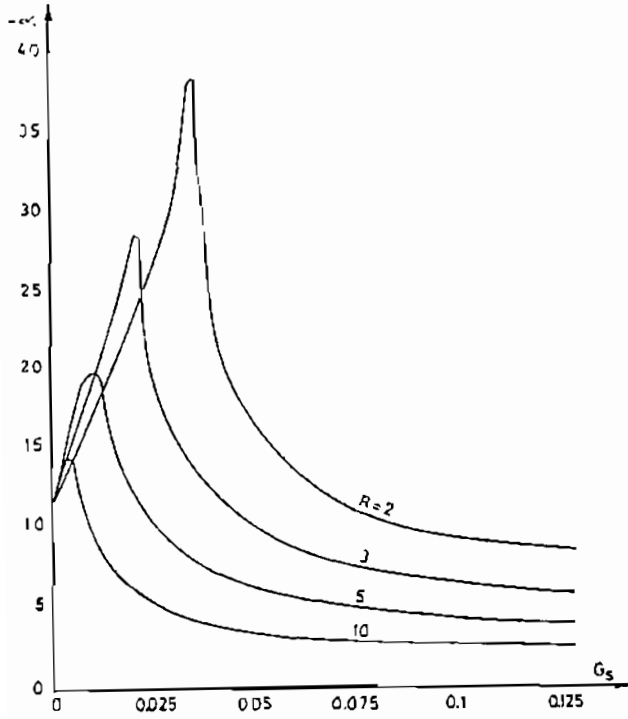

Fig. 4 Damping Factor Versus Stabilizer Gain for Different Time-Constant Ratios, R

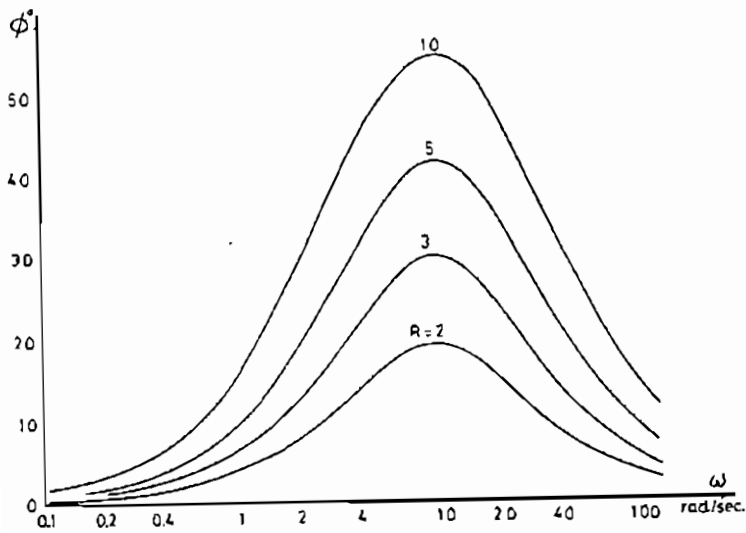

Fig. 5 Phase Compensation Versus Stabilized Frequencies for Different Time-Constant Ratios, R



stabilization of reluctance motors. Fig. 8 illustrates the effect of the stabilizer in increasing motor damping following load changes.

### 8. IMPLEMENTATION

To verify this developed stabilizing technique, a detailed nonlinear simulation, taking all nonlinearities and constraints into account, is constructed. The motor time response to a pulse load disturbance, with and without stabilizer, is shown in Fig.9. This result illustrates substantial improvement in motor performance using speed stabilizing signal to modulate the input voltage. The effect of this signal on modifying the d-axis flux is also demonstrated in the figure. To further elucidate the effect of the stabilizer, a step load increase is applied on the motor shaft and the motor response is shown in Fig.10. The motor, with the stabilizer, moved to the new load conditions without excessive displacement of load angle, and with well-damped rotor swings. Furthermore, the starting characteristics of the motor, with and without stabilizer, are compared in Fig.11. This result illustrates that the stabilizer has no adverse effects on motor starting performance.

### 9. CONCLUSIONS

A method for stabilizing polyphase reluctance motors has been introduced and extensively evaluated. This is based on feeding back a signal proportional to rotor speed, through a lead/lag compensating-network, to modulate the input voltage. The choice of the compensating-network parameters (i.e time constant ratio and

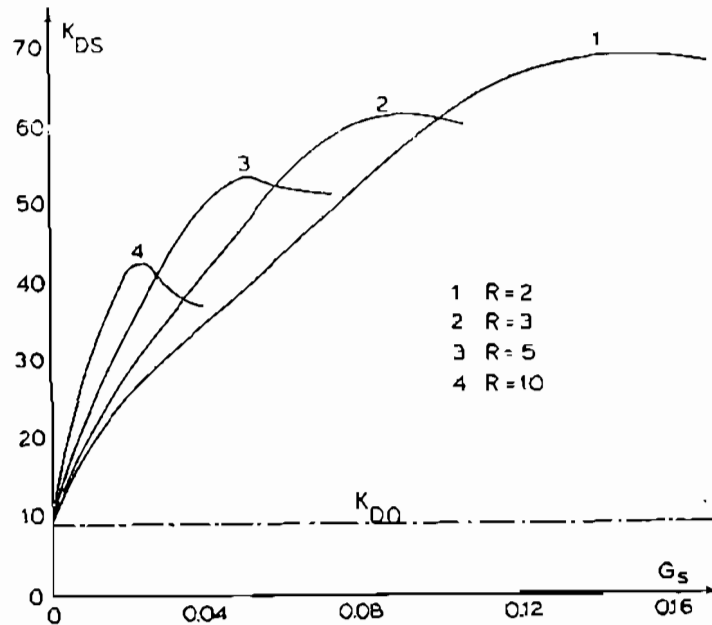

Fig.6 Damping Torque Coefficients Versus Stabilizer Gain for Different Time-Constant Ratios, R

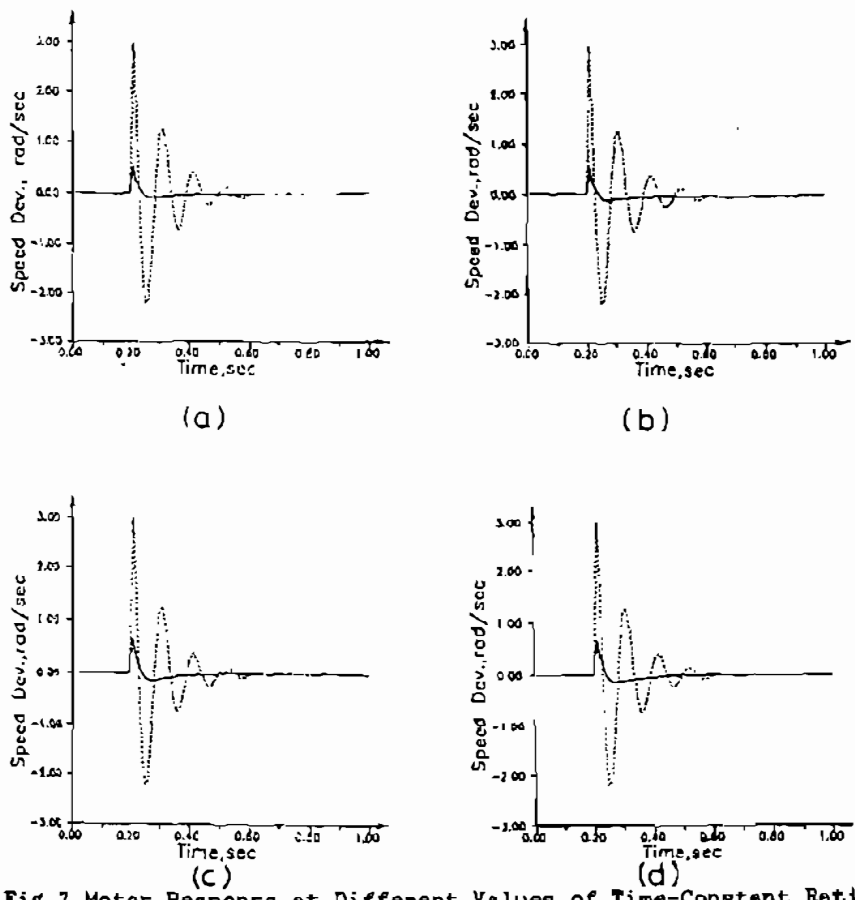

Fig. 7 Motor Response at Different Values of Time-Constant Ratios, R  
 Without stabilizer                      With Stabilizer  
 a-R = 2,  $T_1=0.2S$  &  $G_s=-0.11$ .    b-R = 3,  $T_1=0.206$  &  $G_s= 0.03$   
 c-R = 5,  $T_1=0.16$  &  $G_s=-0.015$ .    d-R = 10,  $T_1=0.113$  &  $G_s= 0.113$

stabilizer gain) which must be defined to add sufficient positive damping is of prime importance. A time constant ratio of 5 was found adequate for reluctance motor compensating networks. The results illustrate outstanding improvement in motor performance using this technique.

10. REFERENCES

[1] Lipo, T. A. and Krause, P. C. " Stability analysis of A reluctance synchronous machine " IEEE Trans. PAS-86, 1967, pp. 825-834.  
 [2] Mehraj, K. and Mchanty, A. K. " Stability of reluctance motors " IEEE Trans. PAS-87, 1968, pp. 2009-2015.

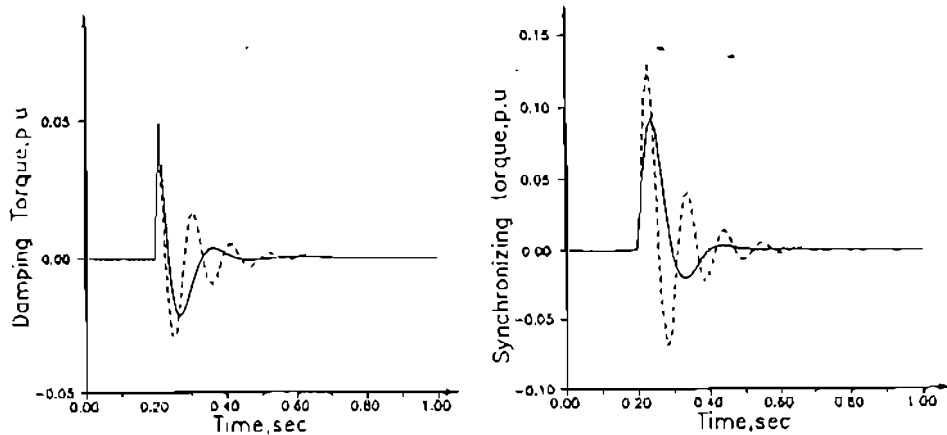

Fig.8 Damping and Synchronizing Torques  
 ----- Without stabilizer  
 ——— With Stabilizer

- [3] Lawrenson, P. J. and Bows, S.R. " Stability of reluctance machines" PROC. IEE , 118, 1971, pp. 356-369.
- [4] Honsinger, V. B. "Stability of reluctance motors" IEEE Trans. PAS-91, 1972, pp. 1536-1543.
- [5] Abdel Kader, F.M., and Osheba, S.M., "Improving transient performance of reluctance motors" Presented at the IEEE Summer Power Meeting, Portland, Oregon, July 24-29, 1988.
- [6] Osheba, S.M and Abdel Kader, F. M, "Dynamic performance analysis of reluctance motors using damping and synchronizing torques" Paper submitted for publication.
- [7] Krause, P. C. " Methods of stabilizing reluctance synchronous machines" IEEE Trans. PAS-87, 1968, pp. 641-649.
- [6] Osheba, S.M. "State-space controllers for AC turbogenerators in a multi-machine system" Ph.D thesis, Liverpool University, UK, May, 1981.
- [9] Larsen, E.V. and Swann, D.A. "Aplying Power system Stabilizer" IEEE trans., Vol. PAS-100, June, 1961.
- [10] Osheba, S.M., Hassan, S.A. and Moursi, G. A., "Parformance pridiction of controlled turbogenerator units using damping and synchronizing torques", Proc. UPEC'84, Dundee, UK, 10-12 April, 1984.
- [11] D'azzo, J.J., and Houpis, C.H., "Feedback control system analysis and synthesis" (McGraw-Hill)

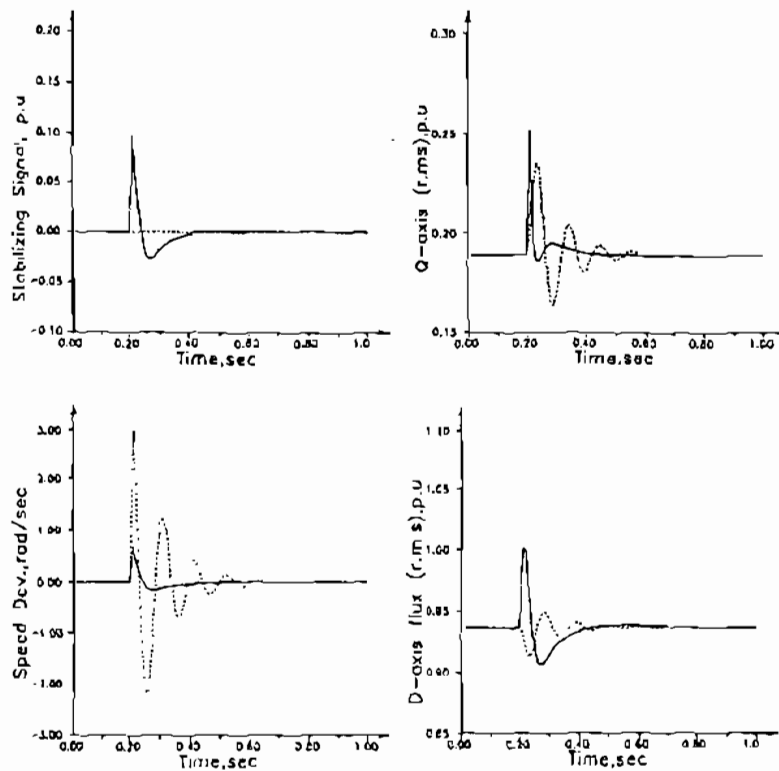

Fig. 9. Response To a Pulse Disturbance  
 $R = 5.0$ ,  $T_1 = 0.16$  &  $G_s = 0.03$

- [12] Osheba, S.M., Alyan, M.A. and Rahim, Y.A., "Comparison of transient performance of superconducting and conventional generators in a multi-machine system" IEE Proceedings, Vol. 135, Pt. C, No. 5, Sept. 1988.
- [13] F.M. Abdel Kador, and S.M. Osheba, "Analysis of dynamic stability of reluctance motors when operating from variable supply", Proc. 19th Annual conference on Modelling and Simulation, University of Pittsburgh, USA, May, 4-5, 1988.
- [14] Lowrenson, P.J., Mathur, R.M. and Stephenson, J.M. "Transient performance of reluctance machines" PROC. IEE, 118, 1971, pp. 777-783.

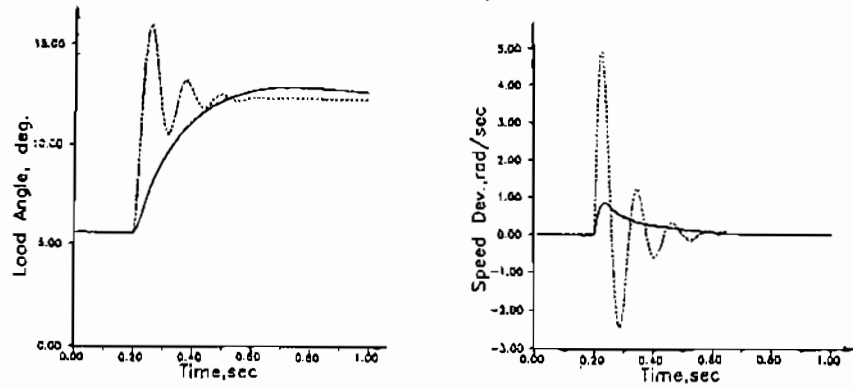

Fig.10 Motor Response to a Step Load Increase  
 - - - Without Stabilizer  
 — With Stabilizer

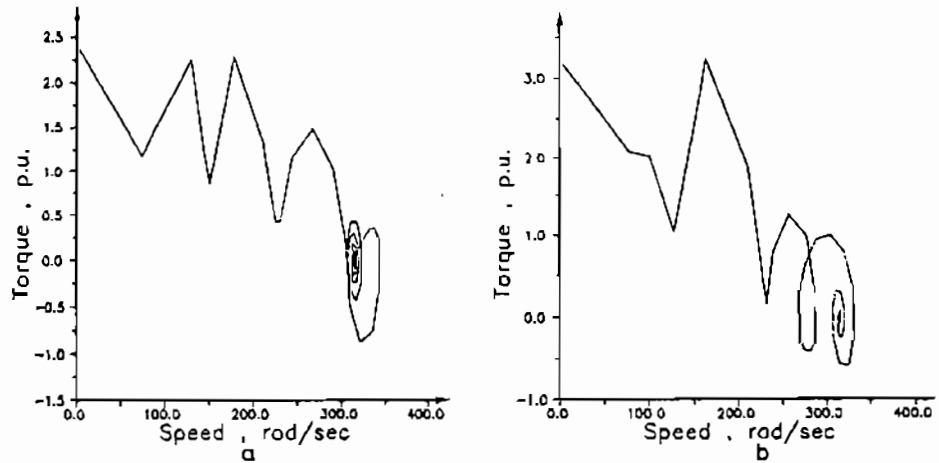
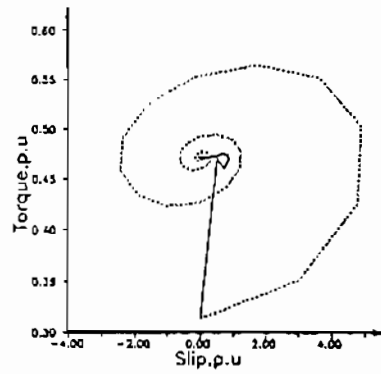

Fig.11 Starting Performance  
 a - Without Stabilizer  
 b - With Stabilizer