

3-1-2021

Fast Power System Restoration via Load Shedding Practices in the Egyptian Power System.

K. Yassin

Assistant Professor., National Energy Control., Center of Egypt.

El-Hussieny Abd-Raboh

Assistant Professor., Electrical Power Engineering Department., Faculty of Engineering., El-Mansoura University., Mansoura., Egypt.

M. Al-Domany

Talkha Power Station.

Follow this and additional works at: <https://mej.researchcommons.org/home>

Recommended Citation

Yassin, K.; Abd-Raboh, El-Hussieny; and Al-Domany, M. (2021) "Fast Power System Restoration via Load Shedding Practices in the Egyptian Power System.," *Mansoura Engineering Journal*: Vol. 17 : Iss. 1 , Article 1.

Available at: <https://doi.org/10.21608/bfemu.2021.166762>

This Original Study is brought to you for free and open access by Mansoura Engineering Journal. It has been accepted for inclusion in Mansoura Engineering Journal by an authorized editor of Mansoura Engineering Journal. For more information, please contact mej@mans.edu.eg.

FAST POWER SYSTEM RESTORATION VIA LOAD SHEDDING PRACTICES
IN THE EGYPTION POWER SYSTEM

الإرجاع السريع لنظم القوى الكهربائية عن طريق طرح الحمل المطبق
فى شبكة مصر الكهربائية

Dr. k. Yassin
National Energy Control
Center of Egypt

Dr. E. Abd-Raboh
Faculty of Engineering
Mansoura University

Eng. M. S. Al-Domany
Talkha Power Station

الخلاصة :

يتعلق هذا البحث بالانزاح الديناميكي لنظم القوى الكهربائية الناتج عن الاضطرابات محدودة القيمة والتي تظل فترة طويلة نسبياً ، ويدرس خلال هذا البحث تأثير فقد القدرة الفعالة للنظام وذلك بعمل برنامج يناقش تغير التردد للنظام أثناء هذه الاضطرابات ومن خلال هذا البرنامج تقدم طريقة عملية لاعادة النظام الى تردده المقتن وذلك باستخدام معادلة انزاح الطاقة (الطاقة الميكانيكية = الطاقة الكهربائية المولدة) مع التعرض للأساليب الآتية :

- ١- الاحتياط الدائر للمحطات المائية مثل كدالة فى تغير التردد بينما الاحتياط الدائر بالمحطات الحرارية يكون غير معتمد على تغير التردد.
- ٢- الاحتياط الدائر لكل من المحطات المائية والحرارية مثل كدالة فى تغير التردد .
- ٣- استخدام أسلوب طرح الحمل .

وقد طبقت هذه الطريقة على نظام القوى الكهربائية لجمهورية مصر العربية مستخدماً برنامج طرح الحمل الموجود بها ، وقد تم دراسة ثلاث طرق للإرجاع ، الطريقة الاولى تهمل الاحتياطى الدائر بينما يمثل الاحتياط الدائر فى الطريقتين الثانية والثالثة كما هو مذكور سابقاً. وفى كل طريقة من الطرق الثلاثة تم دراسة ١٢ حالة من فقد القدرة الفعالة إبداء من ١٥ موات حتى ١٨٠ موات وخلال ثلاث حالات مختلفة من الحمل اليومي (أدنى حمل ، الذروة الصباحية ، الذروة المسائية) .

ABSTRACT

This paper investigates the dynamic stability of power systems due to disturbances of finite magnitude that last for some minutes. In this paper the effect of only active power deficits is investigated. A computer program is developed to discuss system frequency changes during such disturbances. The program implements a practical approach using an energy approach and gives an insight to the following issues :

- (i) hydro spinning reserve is modelled as a function of frequency deviations, while thermal reserve is independent of frequency deviations.
- (ii) hydro and thermal spinning reserves are modelled as a function of frequency deviations.
- (iii) load shedding modelling in steps to trip loads as the frequency decreases.

This approach is applied to the Egyptian power system using the load shedding scheme adopted in the system. Three case studies, each case is studied for twelve active power deficits ranging from 150 MW to 1800 MW during three loading conditions (minimum day, maximum day and maximum evening). The results represent three scenarios for system restoration, the first one neglects the effect of spinning reserve, while the second and third ones implement the utilization of spinning reserve as mentioned here above.

1. INTRODUCTION

Any power system is usually subject to disturbances of quite different nature. These disturbances may, however, be grouped into three types [2] :

- 1- The first type includes disturbance of infinitesimal magnitudes lasting for different periods. Such disturbances usually arise due to the continuous small changes in the load of the power system, as well as the presence of either statisms or even dead bands in the regulating facilities and different time constants of the power system components, which result in delayed response. Steady state stability usually deals with this type of disturbances.
- 2- The second type includes disturbances of big magnitudes and with transitory nature. Such disturbances usually take place due to faults in power systems (line to ground, line to line, line to line to ground and three phase short circuits) and are cleared after a short period (0.08 - 0.3 Sec). This type of disturbances lead to a big transitory change in the operating conditions of the power system and is dealt with in the transient stability studies.
- 3- The third type includes disturbances of finite magnitude and long duration (some minutes or higher). This may take place in a power system due to power deficits. This phenomena is dealt with a dynamic stability investigation.

This paper deals with the concept dynamic stability which is affected by the following factors :

(a) Power Deficit

Power deficits may be pure active, pure reactive or combined. Any of these deficits will affect the frequency of any power system either directly due to active power unbalance or through the variations in the system load due to changes in voltage levels caused by reactive power unbalance. Active power deficits may take place in power systems as a result of the forced outage of generating units, loaded tie lines or due to the switching in of an appreciable load.

(b) Spinning Reserve

Spinning reserve in power systems is usually planned to take care for probable forced outages, which are normally determined based on the past available outage data using probability and statistical methods.

The magnitude of spinning reserve is usually selected to secure a specified reliability level. It is worth mentioning that such investigations are carried out to minimize long period interruptions in the power supply and usually they have nothing to do with the dynamic behavior of power system during the transition period after active power deficits occur and before the stationary utilization of the spinning reserve. The effect of the spinning reserve at hydro and thermal power stations depends upon the dynamic response of the different components of the control system of these stations during the period of active power deficits.

(c) Characteristics Of Loads

The constituents of electrical loads in power system are quite different and hence their response to frequency and voltage variation. The overall response of electrical loads is usually determined from field tests, and is mainly characterized by the per-unit variation of the active power with the frequency and voltage. If during dynamic behavior investigations the effect of voltage variations is neglected, then the per-unit variation of the active load with frequency (i.e. the load regulation coefficient $\alpha = \Delta P / \Delta f$) is the only factor which affects the dynamic behavior of power systems. This factor was reported [1] to be less than 2. The analysis of the field data available for Northern Egypt power system showed that a characteristic value for the load regulation coefficient α is about 1.4.

(d) Automatic Load Shedding

Automatic load shedding (ALS) under emergency conditions proved to be the most effective measure securing the dynamic stability

of power systems during power deficits. The ALS is widely used in most of power systems in the world. Any ALS program is usually characterized by :

The number of frequency levels, the time delay of each level, the percentage load connected to each level, the highest and lowest tripping frequencies, as well as the minimum frequency difference allowed between the various frequency levels.

The ALS programs are usually planned to trip the noncritical customers at higher frequency levels, while more important loads at lower levels. The most important loads (loads of first category) are either maintained in service or partially tripped, if absolutely necessary, at lowest frequency level.

An optimum ALS program has to secure at any level of power deficit the lowest frequency drop with minimum amount of load tripping.

This paper contains six sections in addition to the introductory section.

2. MATHEMATICAL MODEL

The sudden active power deficits is followed by system frequency transient conditions. The complete representation of this transient is very complex and calls for the modelling of system components to a great degree of detail . The frequency load shedding function developed in this work uses a simplified analysis , which although approximate , is regarded as adequate for planning purposes.

In this simplified analysis an energy approach is used , so that the rate of change of stored kinetic energy (i.e frequency) at any instant is equal to the difference between power input to the system (i.e prime mover power) and power output (i.e load).

2.1 ALGORITHM AND MODELS

The energy approach is represented by the following equation :

$$(2H) (P) \dot{\sigma} + \alpha (P_{Lo} - P_s) \sigma = P_1 + P_2 + P_3 - \Delta P + P_s \quad (2.1)$$

where:

- σ : frequency deviation in p.u of the nominal frequency
- P_s : load shed at time t in p.u
- P_1^s : fast spinning reserve used at time t from thermal non-reheat plant in p.u.
- P_2 : fast spinning reserve used at time t from thermal reheat plant in p.u.
- P_3 : fast spinning reserve used at time t from hydro plant in p.u.
- α : load regulation coefficient of the system (change of load as a function of frequency deviation)
- (P) : d/dt

(2H): total inertia constant of the system in seconds which is modified every integration step to account for load shedding using the equation :

$$(2H) = (2H)_0 - RL * TL * PSHED$$

where :

(2H)₀: initial inertia constant of the system in seconds and is defined as follows :

$$(2H)_0 = \left[\left(\sum_{i=1}^{np} N(i) * UNIR(i) \right) + RL * TL * P_{Lo} \right] / P_{Lo}$$

Where :

- N = number of units in each plant
- UNIR = inertia constant of each unit in MW.sec
- RL = rotating load percentage
- TL = rotating load inertia in sec
- np = number of plants
- P_{Lo} = Initial system load before disturbance
- ΔP = deficit power in p.u
- PSHED = total load shed up to this step in per unit

2.1.1 Spinning Reserve Modelling

Model (1) :

In this model hydro spinning reserve is modelled as a function of frequency deviations, while thermal reserve is independent of frequency deviations.

The equivalent hydro and thermal plants are represented as follows :

(a) The equivalent non-reheat thermal plant :

$$\begin{aligned} P_1 &= \frac{P_{1c}}{T1} t & \text{for} & \quad 0 \leq t \leq T1 \\ P_1 &= P_{1c} & \text{for} & \quad t > T1 \end{aligned} \quad (2.2)$$

where :

- P_{1c} = maximum fast spinning reserve available from non-reheat thermal plant in p.u.
- T1 = valve time of non-reheat thermal plant
- t = time measured from the beginning of disturbance

(b) The equivalent reheat thermal plant :

$$V_2 = \frac{P_{2c}}{T_2} t \quad \text{for} \quad 0 \leq t \leq T_2 \quad (2.3)$$

$$V_2 = P_{2c} \quad \text{for} \quad t > T_2$$

and

$$P_2 = \frac{1 + (m) (Th) (P)}{1 + (Th) (P)} (V_2) \quad (2.4)$$

where

V_2 = incremental opening in the steam valve of the reheat thermal plant at time t .

P_{2c} = maximum fast spinning reserve available from reheat thermal plant.

T_2 = valve time of steam valve of reheat thermal plant

m = fraction of power in high pressure section of turbine.

Th = time constant of reheat thermal plant.

(c) The equivalent hydroelectric plant :

$$G = \frac{\sigma + T_d (P) \sigma}{\delta + \delta (T_3) (P)} P_{n3} \quad \text{for} \quad - (P_{n3} - P_{3c}) \leq G \leq P_{3c}$$

where

$$T_3 = \frac{T_g + T_d (\delta + \delta t)}{\delta} \quad (2.5)$$

and

$$(P) G = 0 \quad \text{for} \quad P_{3c} < G < - (P_{n3} - P_{3c})$$

$$P_3 = \frac{1 - (T_w) (P)}{1 + 0.5 (T_w) (P)} (G) \quad (2.6)$$

where

T_g = Response time of speed governor

δt = Temporary droop of speed governor

G = Change in the opening of the hydro plant inlet vane .

T_d = Dashpot time constant of the hydro plant speed governor.

δ = Permanent droop of the hydro plant speed governor.

P_{n3} = Nominal capacity of hydro plant used for regulating purposes.

P_{3c} = Maximum fast spinning reserve available from hydro plant in p.u.

T_w = water starting time in the hydro intake

A block transfer diagram of this model is shown in fig (2.1).

Model (2) :

In this model both hydro and thermal spinning reserves are modelled as a function of frequency deviations. The equivalent hydro and thermal plants are represented as follows :

(a) The equivalent non-reheat thermal plant :

$$P_1 = \left[\frac{P_{n1}}{\delta_1} \right] \frac{-1}{1 + T1 (P)} \quad (\alpha) \quad \text{for } -(P_{n1} - P_{1c}) \leq P_1 \leq P_{1c} \quad (2.7)$$

$$P_1 = P_{1c} \quad \text{for } P_{1c} < P_1 < -(P_{n1} - P_{1c})$$

where :

P_{n1} = nominal rated power output of regulating non-reheat plant
 δ_1 = average governor droop setting

(b) The equivalent reheat thermal plant :

$$V_2 = \left[\frac{P_{n2}}{\delta_2} \right] \frac{-1}{1 + T2 (P)} \quad (\alpha) \quad \text{for } -(P_{n2} - P_{2c}) \leq V_2 \leq P_{2c} \quad (2.8)$$

and

$$P_2 = \frac{1 + (m) (Th) (P)}{1 + (Th) (P)} \quad (V_2)$$

$$P_2 = P_{2c} \quad \text{for } P_{2c} < P_2 < -(P_{n2} - P_{2c})$$

where :

P_{n2} = nominal rated power output of regulating reheat plant
 δ_2 = average governor droop setting

(c) The equivalent hydroelectric plant :

Same as mentioned above in equations (2.5), (2.6) of model (1).

A block transfer diagram of this model is shown in fig (2.2).

2.1.2 Load shedding model

The load shed scheme is modelled as number of frequency steps (this number differs from one utility to another), each step is characterized by a percent of load to be shed in addition to the

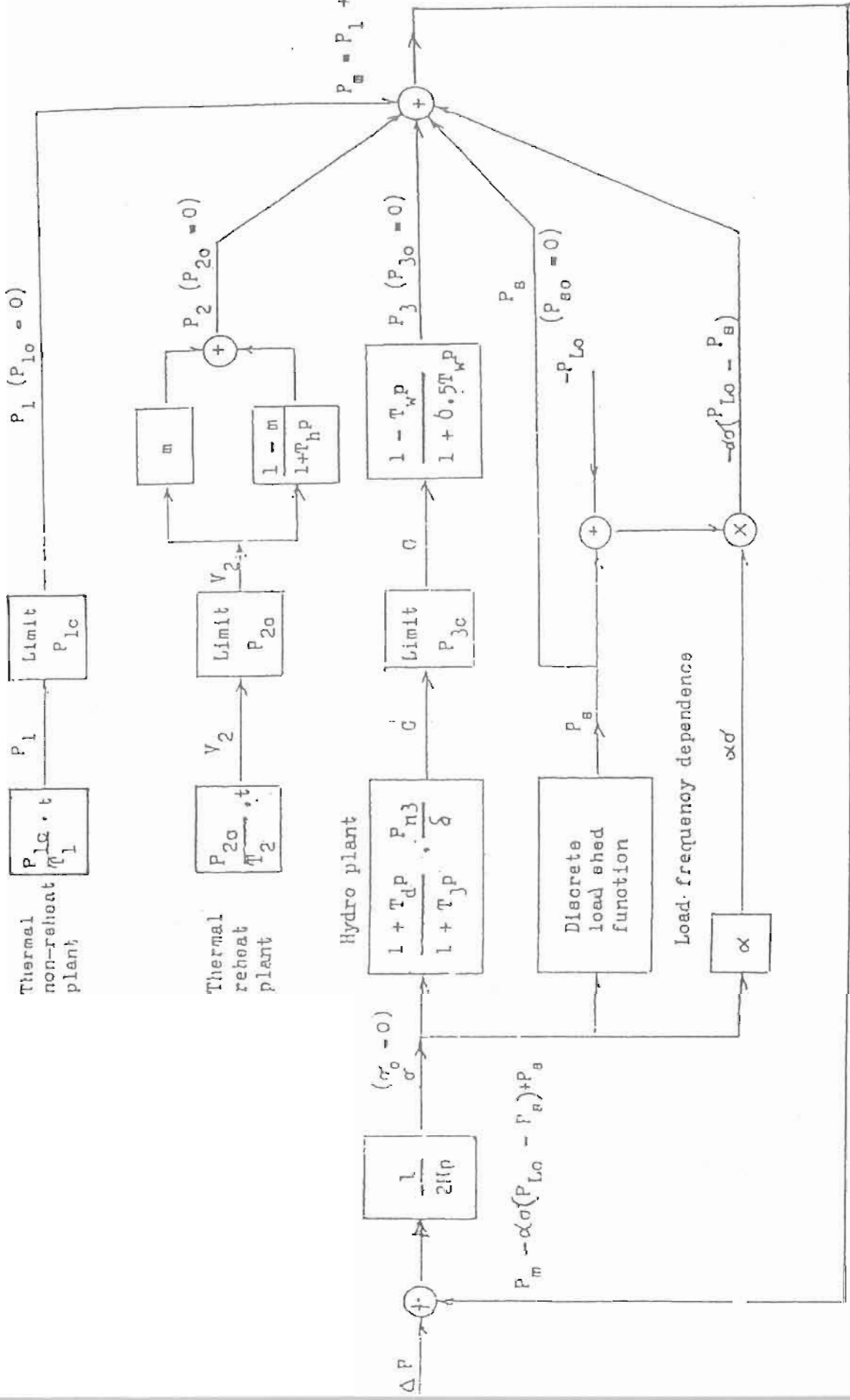

A block transfer diagram of model (1)

FIG (2.1)

Note $\sigma = f - f_0$

allowable time delay. If the system frequency is reduced to the level that matches the frequency setting of a load shedding step, then the amount of load corresponding to such step is shed after the step time delay.

3. PROGRAM DEVELOPED

The frequency load shedding program is written in Fortran to implement the algorithm described in section two as follows :

- (1) When an active power deficits occur, the energy balance equation (2.1) is no longer satisfied and the frequency begins to change.
- (2) The model starts by initializing the variables to zero and solving the energy balance equation for σ and σ' (a dot is used to denote first derivative with respect to time).
- (3) A flag is defined in the input data for spinning reserve if the flag is set to "Y" then the first model is used, otherwise the second model used.
 - (a) for the first model :
 - using σ and σ' computed in step (2);
 - (i) G , G' and P_3 for hydro are computed
 - (ii) P_1, P_2 for thermal non-reheat and reheat are computed
 - (b) for the second model :
 - using σ and σ' computed in step (2);
 - (i) G , G' and P_3 for hydro are computed
 - (ii) P_1, P_1' for thermal non-reheat are computed
 - (ii) V_1^2, V_2, P_2 for thermal reheat are computed
- (4) If the system frequency is reduced to the level that matches the frequency setting of a load shedding step, then the amount of load corresponding to such step is shed after the step time delay.
- (5) If the frequency return to its nominal value or the maximum available time is satisfied, the program stop, otherwise the program return to step (2).

4. IMPLEMENTATION

The developed program is used to study the restoration of the Egyptian power system to its nominal frequency after sudden power deficits for the following scenarios :

- 1- load shedding without any spinning reserve.
- 2- load shedding with the first spinning reserve model.
- 3- load shedding with the second spinning reserve model.

Each scenario is studied for twelve active power deficit ranging from 150 MW up to 1800 MW deficit with 150 MW increment, during the three periods; maximum evening, maximum day, and minimum day. The load shedding scheme (Table 1) used in the study cases represents the seven main load shedding steps installed in the

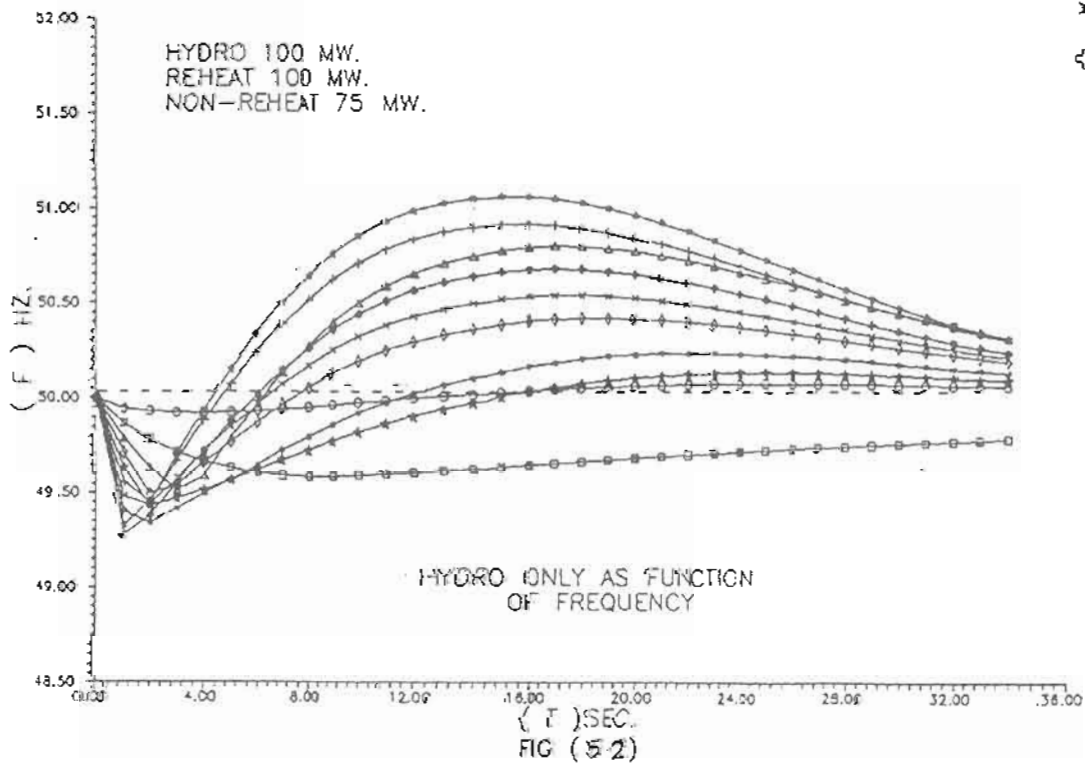
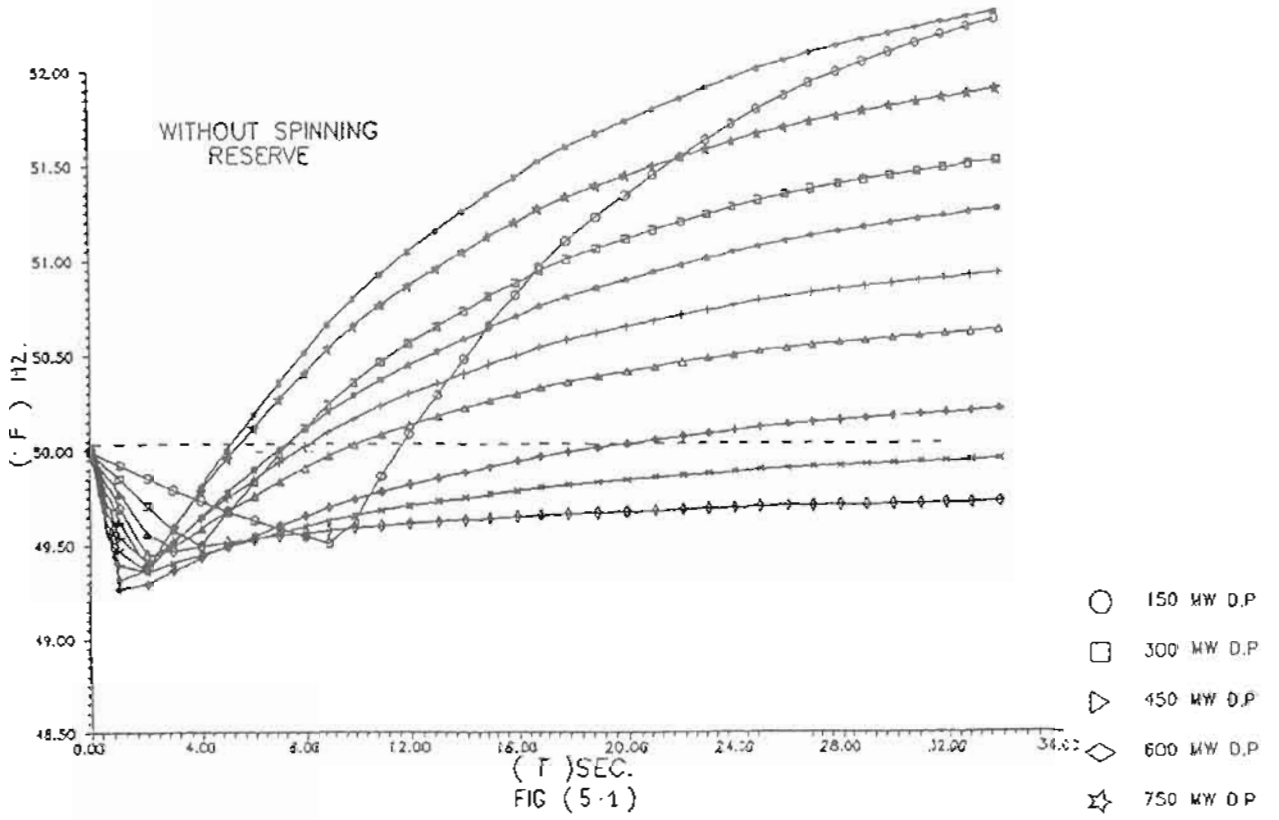

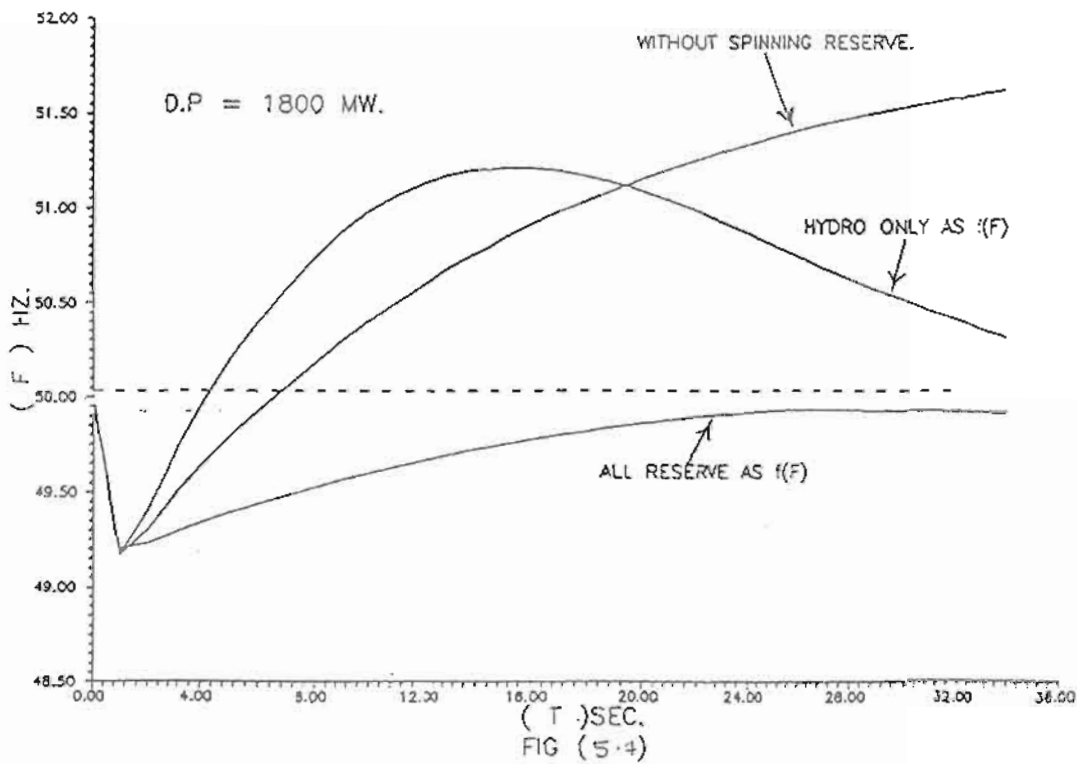
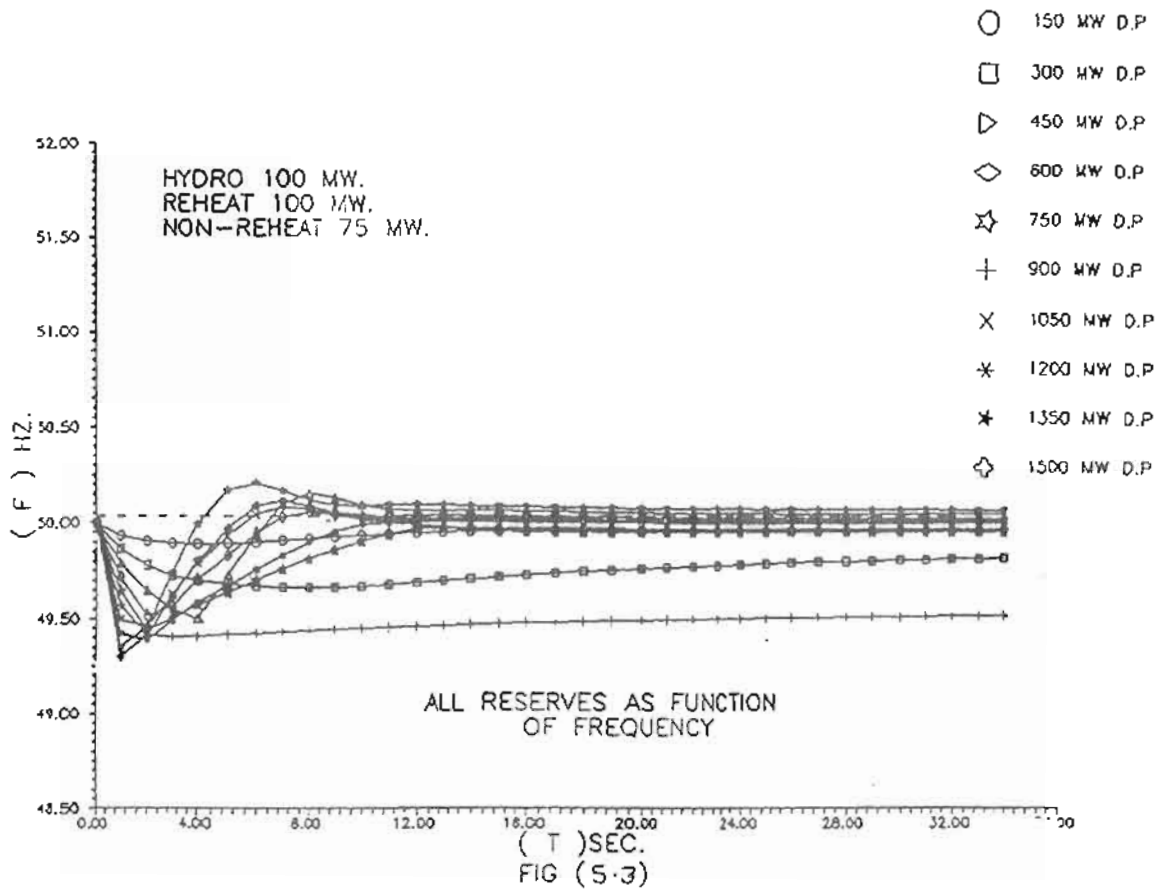

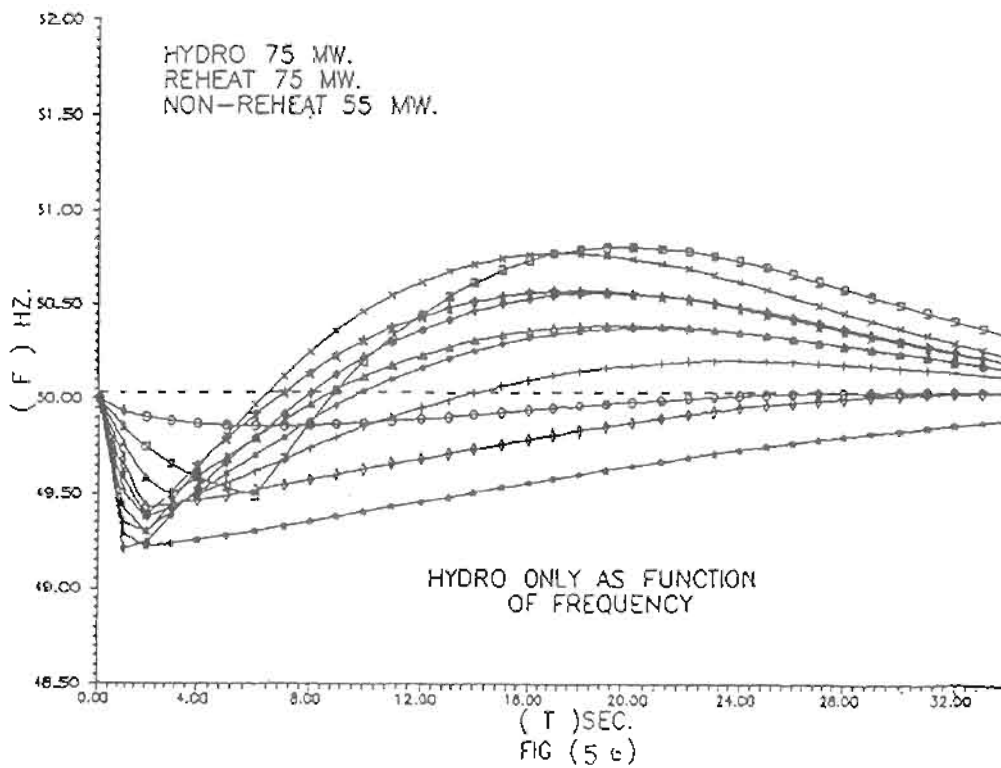
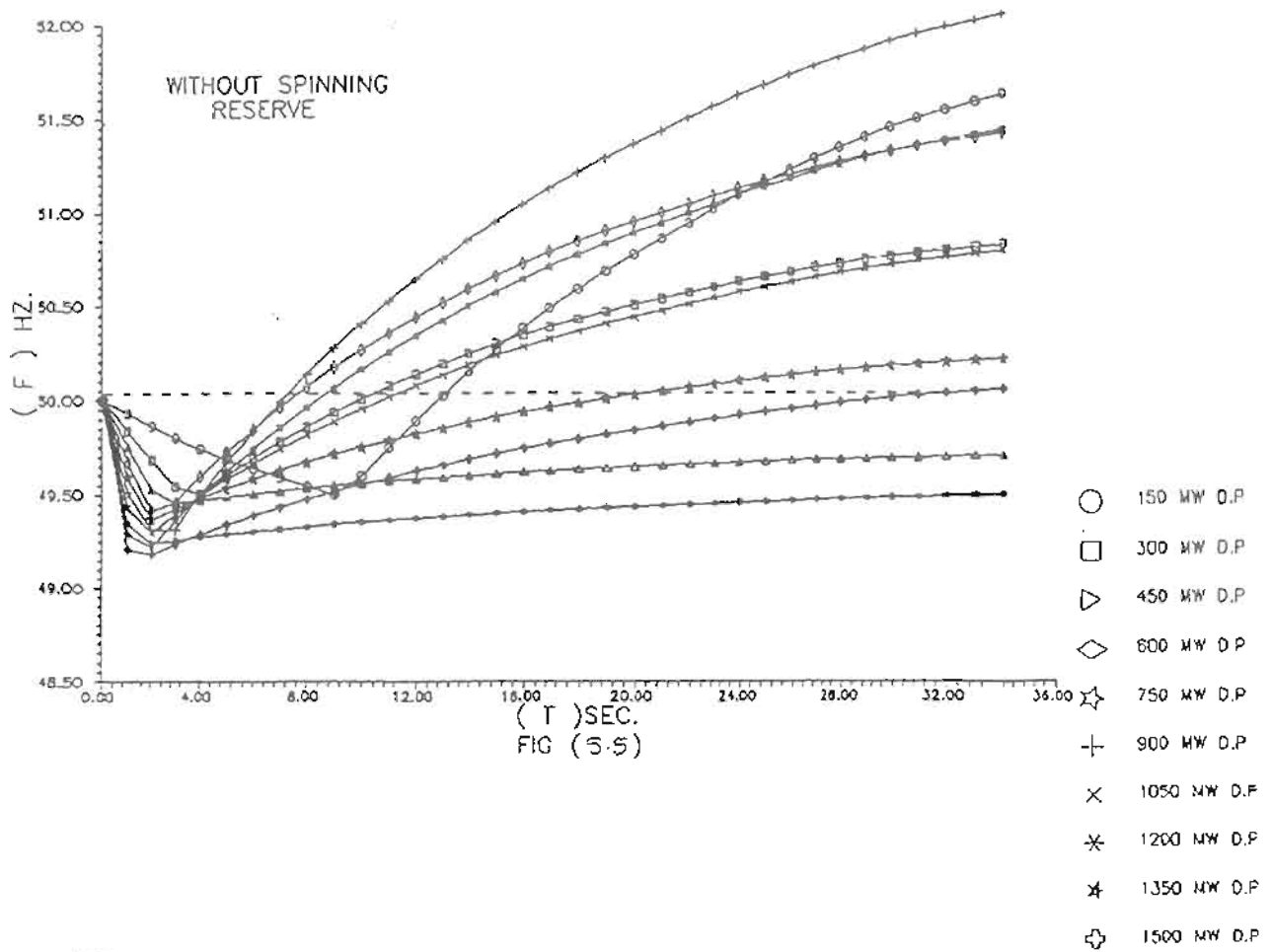

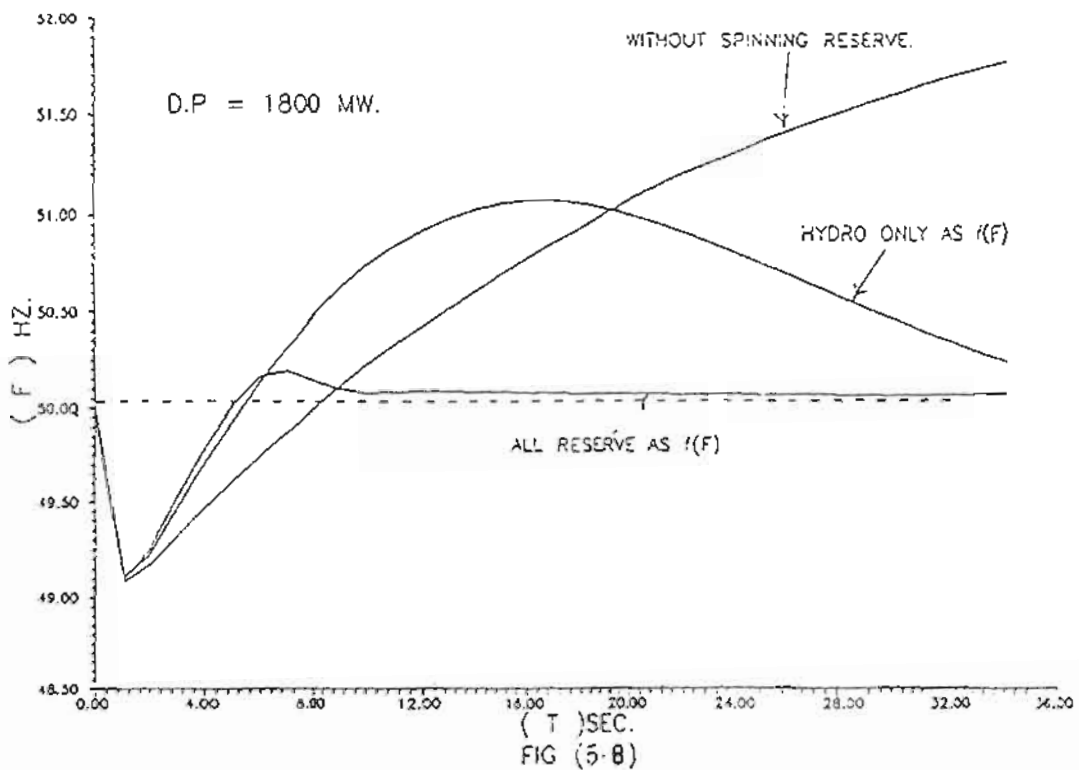
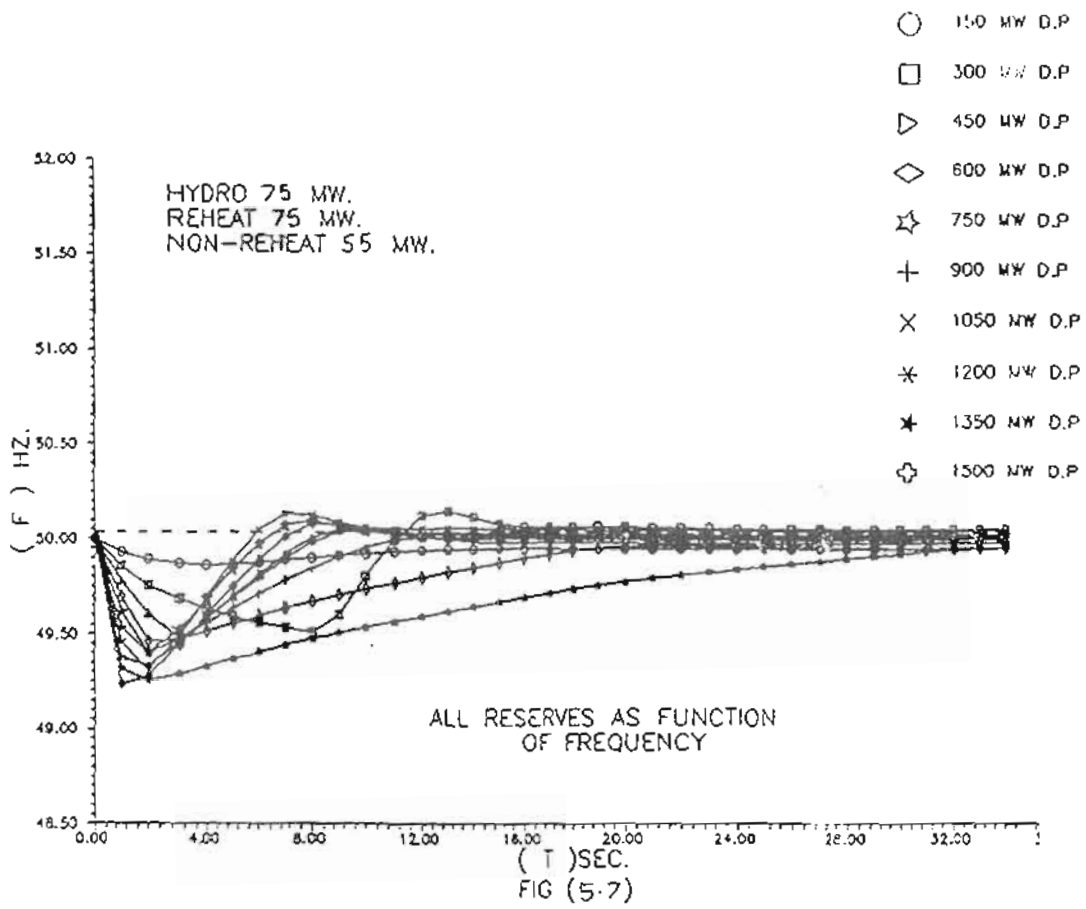

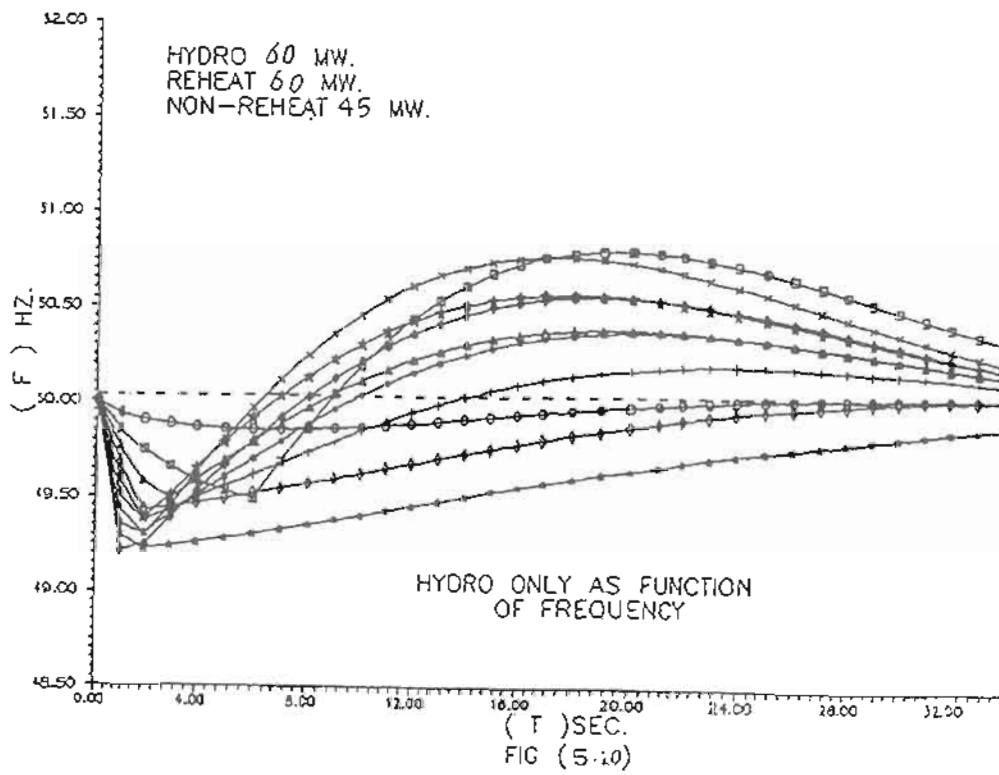
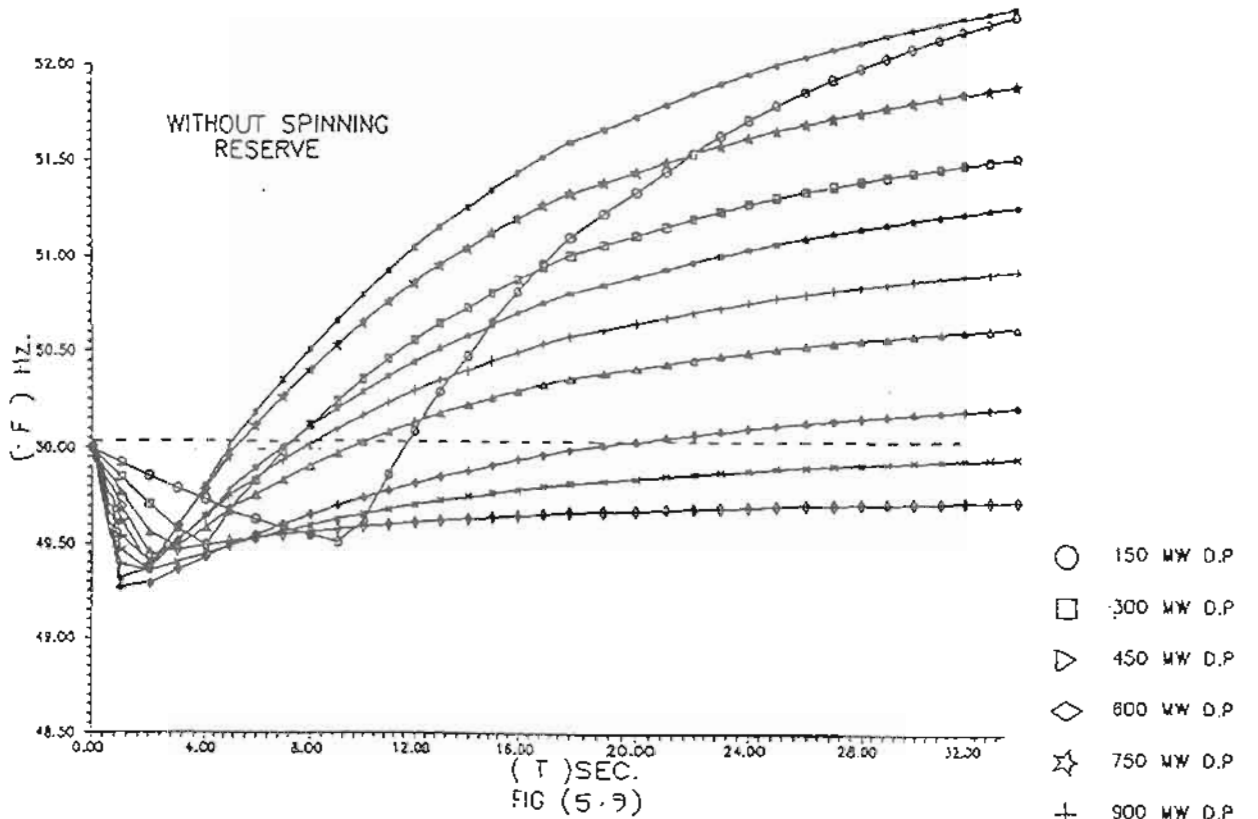

- 150 MW D.P
- 300 MW D.P
- ▷ 450 MW D.P
- ◇ 800 MW D.P
- ☆ 750 MW D.P
- + 900 MW D.P
- × 1050 MW D.P
- * 1200 MW D.P
- ★ 1350 MW D.P
- ⊕ 1500 MW D.P

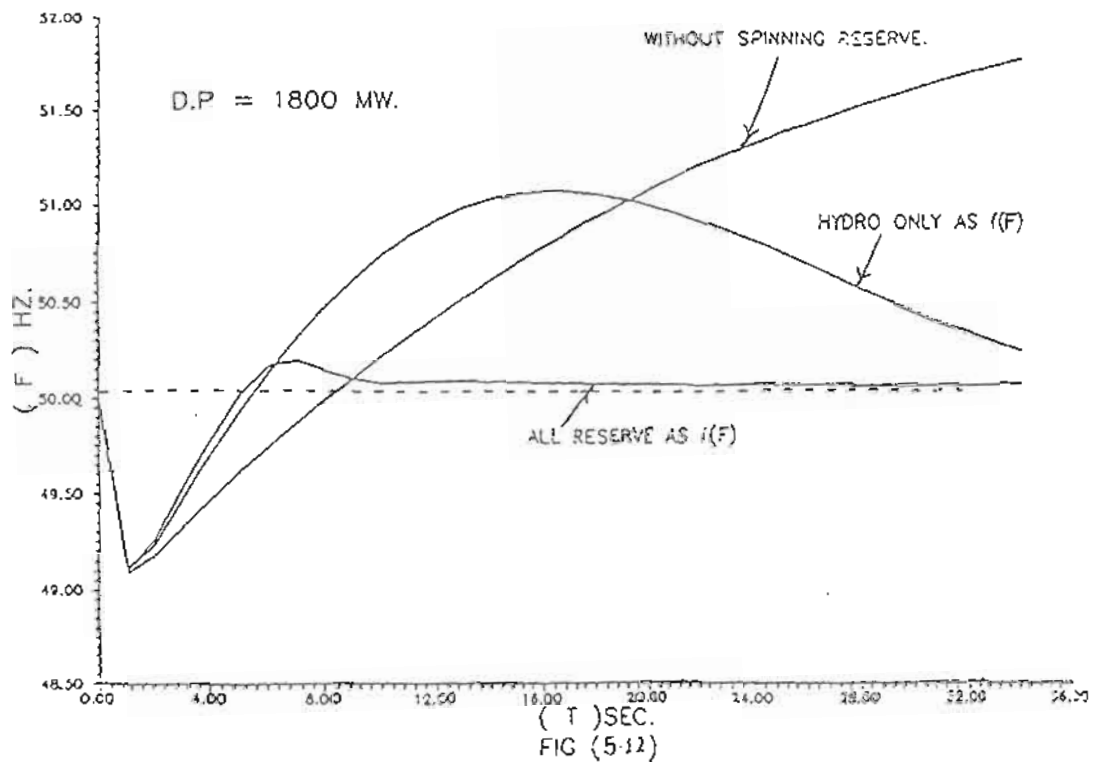
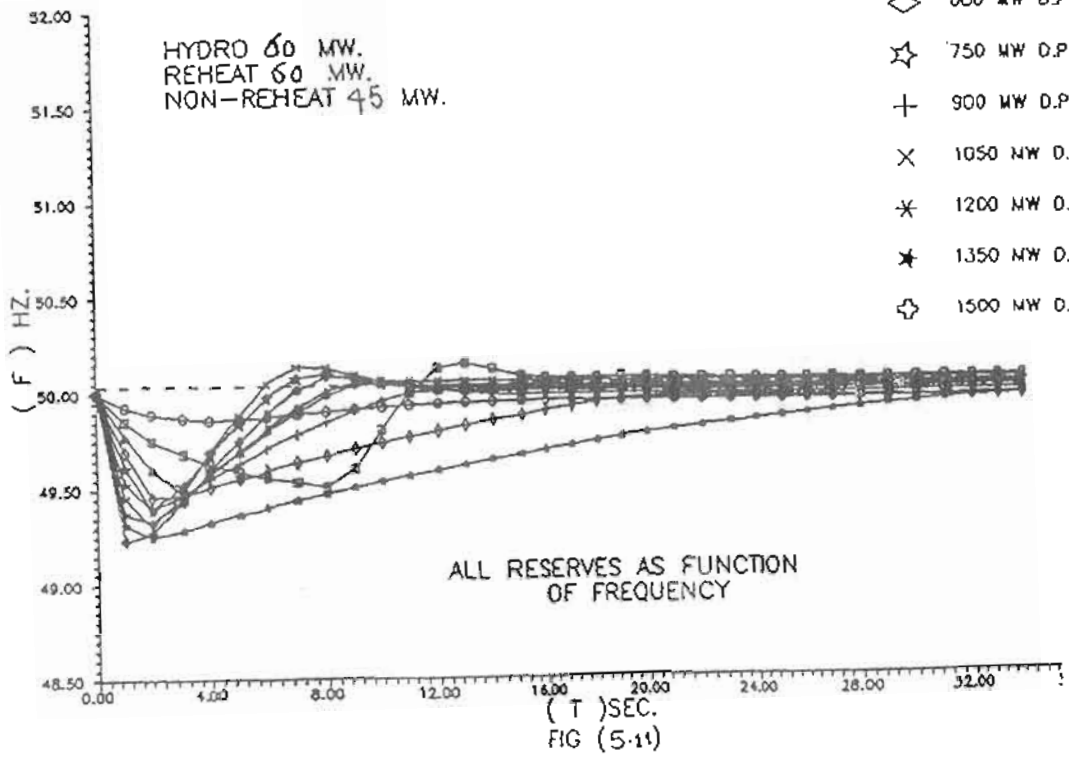

different substations of the Egyptian power system.

F	49.5	49.4	49.3	49.2	49.1	49.0	48.9
%	8	7	7	7	9	12	10

Table (1)

5. ANALYSIS OF RESULTS

The figures from (5.1) to (5.12) show the frequency / time for the Egyptian unified power system for above studied cases. From these figures it is evident that the third scenario is the best and the fastest one since it achieves the following :

- (1) avoids excessive load shedding.
- (2) reduces the frequency overshooting during the restoration before arriving to the nominal frequency.
- (3) takes less time to restore the frequency to its nominal value.

6. CONCLUSIONS

Extensive analytical investigations have been carried out to develop a frequency actuated load shedding program . Based on these investigations a number of general conclusions can be drawn :

- (1) To minimize the potential for excess load shedding , a multistage shedding program is desirable .
- (2) To minimize the overshoot frequency above 50 HZ during the restoration, both hydro and thermal reserves must be modelled as a function of frequency deviations.
- (3) The frequency set point for the first stage of load shedding should be sufficiently low such that spinning reserve may be effective in the system restoration for small disturbances .

7. REFERENCES

- [1] L.K. Kirachmeyer, "Economic control of interconnected powers systems", John wiley and sons, Inc. , New York 1959.
- [2] Hamdy EL-Shear, "dynamic behavior of power systems under active power thrusts" , Cairo 1972.
- [3] Power technologies , Inc , course notes on generation dynamic and control , July 1973.

- [4] Market Survey for nuclear power in developing countries, General summary, Appendix H, IAEA 1973.
- [5] Associated nuclear services, Notes on modified average system frequency model, 1975.
- [6] Yehia Abu-Alam, "Dynamic performance of power systems with consideration of system automatics", Ph.D thesis, Ain Shams University, Cairo 1978.
- [7] Nuclear power planning study for Hong Kong . A.J. Covarrubias, Y. Kong , H. Soo, 1979 IAEA Vienna .
- [8] C. Treewittayapoom, "studies on the coordination among steps of an under frequency load shedding scheme", Cigre, 1990 Session.
- [9] "Dynamic behaviour and security assessment of the Egyptian power system", Joint research between Cairo university and the Egyptian Electricity Authority, 2nd report, Feb 1991.