

6-1-2021

## A Study of Separation Efficiency of Geotextiles.

Hemdan Abou-Taleb

*Associate Professor., Textile Engineering Department., Faculty of Engineering., El-Mansoura University., Mansoura., Egypt.*

Follow this and additional works at: <https://mej.researchcommons.org/home>

---

### Recommended Citation

Abou-Taleb, Hemdan (2021) "A Study of Separation Efficiency of Geotextiles.," *Mansoura Engineering Journal*: Vol. 18 : Iss. 2 , Article 11.

Available at: <https://doi.org/10.21608/bfemu.1993.165315>

This Original Study is brought to you for free and open access by Mansoura Engineering Journal. It has been accepted for inclusion in Mansoura Engineering Journal by an authorized editor of Mansoura Engineering Journal. For more information, please contact [mej@mans.edu.eg](mailto:mej@mans.edu.eg).

## A STUDY OF SEPARATION EFFICIENCY OF GEOTEXTILES

دراسة كفاءة الفصل لأقمشة الجيوتكستائل

BY

Assoc. Prof. Dr. HEMDAN A. ABOU-TALEB

Textile Engineering Dept., Faculty of Engineering, Mansoura University, Egypt.

الخلاصة :

البحث الحالي هو دراسة لامكانية التنبؤ، بكفاءة الفصل لأقمشة الجيوتكستائل الغير منسوجة المستخدمة في هندسة الطرق . وذلك عن طريق المقارنه بين توزيع ماس القماش وتوزيع حبيبات الرمل المستخدمه . ولتوقيع التوزيع التفاضلي والتكامل لمام القماش امكن تصميم جهاز خاص لتعيين حجم الماء الممتص وارتفاع عمود السائل خلال عدده طبقات ماس القماش مترامه افقا وذلك عن طريق استخدام الخاصيه الشعريه عند حاله الاتزان . ولتوقيع توزيع حبيبات الرمل المستخدمه امكن استعمال طريقه العريله الجافه لعينه من الرمل وزنها ٥٠٠ جم مستخدما طريقه المتجمع الماعد . ولتقييم كفاءة الفصل لأقمشة الجيوتكستائل امكن عربلة رمل بحبيبات متدرجه الحجم خلال كل قماشه على حده وامكن توقيع العلاقه بين سبه الرمل المار خلال القماش وقطر حبيبات الرمل . نقطه تقاطع هذه العلاقه مع المنحنى المتكامل لتوزيع ماس القماش تشير الى النسبه النظرية للرمل المار خلال كل قماشه على حده . وبمقارنه هذه النسبه مع سبه الرمل المار معمليا خلال كل قماشه على حده وجد انها متقاربان الى حد كبير . هكذا من الدراسه السابقه امكن التنبؤ بكفاءة الفصل لأقمشة الجيوتكستائل واختيار احسن الاقمشه المناسبه في هندسة الطرق .

**ABSTRACT** - The present investigation deals with the study of separation efficiency of geotextiles used for civil engineering works by means of the comparison between pore size distribution of fabrics and particle size analysis of used soil. For plotting the integral and differential distributions of fabrics pores, a special apparatus was designed. This apparatus was used to characterize water wickability behaviour of geotextile fabrics. The method is based on the determination of the volumetric absorbed water and water height penetrated through multi-layers of geotextile fabrics using capillary phenomena at equilibrium condition. And consequently pore size distribution of fabrics could be plotted. Also an experimental technique (dry sieving of soil with and without fabric) used to evaluate fabric separation efficiency is investigated. The experimental results are compared to the calculated separation efficiency obtained using the pore size distribution. The calculated values of separation efficiency (passage percent of soil) was found to be fairly close to those observed experimentally.

### 1. INTRODUCTION

Geotextiles are defined as permeable fabrics which act compositely with soils and rocks. They are products of the textile industry and include woven and nonwoven fabrics [1]. In civil engineering there are many different applications for geotextiles.

However, the products perform only four basic functions. The four basic functions are separation, filtration, drainage and reinforcement. A geotextile functions as a separator when it is placed between a fine soil and coarse material and prevents the two materials from mixing. A geotextile functions as a filter when placed in contact with a soil, it allows water to pass through while preventing the passage of soil particles. Both permeability (requiring an open fabric structure) and soil retention (requiring a tight fabric structure) are required simultaneously. A geotextile functions as a drain when it collects a liquid or a gas and conveys it towards an outlet. The flow of water into the drain is controlled by the geotextile which must also perform a filter function to prevent loss of capacity due to soil entry into the drain. A geotextile functions as a reinforcement when it improves by its tensile behaviour, the mechanical properties of an earth structure by interacting with soil through interface shear [2-4]. In the many applications of geotextiles, the product rarely serves only one function. However, in most situations one particular function usually predominates with the others performing secondary functions.

## 2. MEASUREMENT OF PORE-SIZE DISTRIBUTION

In selecting a geotextile for civil engineering works, one must consider the different characteristics of the fabric as they relate to the type of application. To evaluate the performance of a geotextile with respect to some of its applications in separation and filtration requires characterization of its physical properties. The important factors that affect physical properties are pore diameter and pore size distribution. Standard methods for testing these factors are not readily available. Different methods [5] have been proposed for evaluating the opening size of geotextiles: dry sieving [6-9], wet sieving [10], hydrodynamic filtration [11-13] and image analysis [14]. Since these methods are quite different, it is difficult to compare results obtained by them, so that a standard for opening size has still to be developed. Wet sieving is similar to dry sieving in procedure which the soil is sieved through the fabric. In hydrodynamic filtration, sieving by a standard soil is carried out under alternate flows of water. It was reported that, for the same fabric, each of the above methods will show a different pore size distribution and in particular a different maximum pore size. Furthermore, the above methods are all very time-consuming.

One of the most important properties of geotextiles is their pore size distribution. Pore size distribution can influence the rate and magnitude of spontaneous uptake of liquids or the resistance to forced penetration. The correlation of the particle-size distribution of the soil with the pore-size distribution of the fabric is a necessity in the evaluation of the performance of a geotextile with respect to some of its functions, such as separation, filtration and drainage; and in the selection of a geotextile to fulfil the requirements of these applications, when used as a separator, for example, the pore sizes of geotextiles. For determining pore size distributions, particularly for fibrous materials, both woven and nonwoven geotextiles; four general approaches can be used to obtain pore size distribution data: Optical scanning, fluid flow-through, mercury intrusion and liquid extrusion [15-19].

This paper describes the designed apparatus and procedure for pore size distribution measurements using liquid extrusion technique. The technique involved to enable pore size distribution to be carried out is described. This study attempts to evaluate the soil separation efficiency of seven commercially available geotextiles differing in fabric construction, fabric weight and thickness.

### 3. EXPERIMENTAL TECHNIQUES

Two experimental techniques could be used to obtain pore size distributions for both fabrics and soil respectively.

(a) The first technique of fabrics is based on the determination of the volumetric absorbed water and water height penetrated through horizontal multi-layers of geotextile fabrics at equilibrium. This technique could be achieved using the apparatus shown in Figure 1. The apparatus is composed of vessel (1), measuring tube (2) and the liquid level controlling tap (3) and pipe (4). The water is poured into the vessel by a tap (3). The vessel containing a solution of potassium bichromate with a concentration of 1 gram/litre is connected to flexible polyethylene pipe (4) for draining to keep the liquid level in the vessel at a constant height. The measuring tube of 6-cm diameter is painted with a vaseline from the inside surface to prevent the fast penetration of water through the inside surface area of measuring tube. The bottom end of the measuring tube is covered with a metal wire mesh (5) (1.5x1.5 mm). Multi-layers (sample assembly) (6) of circular specimens 6-cm diameter are put in the measuring tube under a weight (7) to give a constant pressure of 34.5 g/cm<sup>2</sup>. At the start of measurement, the measured tube is suspended from the hook (8) and is movable up and down vertically and its bottom end is immersed in the vessel containing a solution of potassium bichromate which the zero division of the measuring tube must coincide with the solution level. Subsequently, liquid penetrated into the lower part of the measuring tube and made contact with the sample assembly. The height to which the solution rises along the measuring tube through the sample assembly after 24 hours (standard time of capillarity at equilibrium) is recorded. Afterwards, a number of watch-glasses are weighed. The wetted specimens of each sample clothing are put on a sheet of glass inclined at 30° to the horizontal level. After exactly one minute for draining the wetted specimens are weighed before and after drying using watch glasses and a sensitive balance. The sheet of glass is wiped dry with a paper handkerchief before repeating with another sample.

For knowing pore size distribution of geotextiles using capillary phenomena, The radius of capillary (r) can be determined. Pore radius (r) of the wetted fabrics with a white alcohol could be measured by the apparatus established by Hemdan Abou-Taleb [20] using the following equation :

$$r = \frac{2 S}{P \cdot g} \cdot 10^4, \quad \text{microns} \quad \dots (1)$$

where S = surface tension of the white alcohol in dynes per cm at the temperature at which the test is carried out, S = 25.9 dyne/cm at 23°C ,

P = Pressure in cm of water,

g - acceleration of gravity, 981 cm/Sec<sup>2</sup>.

On the other hand, the pore radius could be measured in the present study by the following Equation [21].

$$r = 2 S \cos (\theta) / P g h, \quad \text{meter} \quad \dots (2)$$

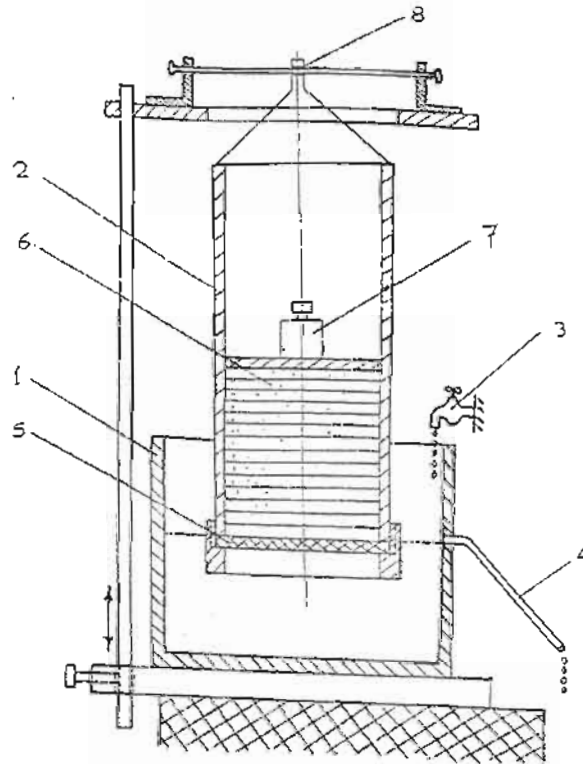

Fig. 1. An Apparatus For Testing Absorbability of Felt Fabrics

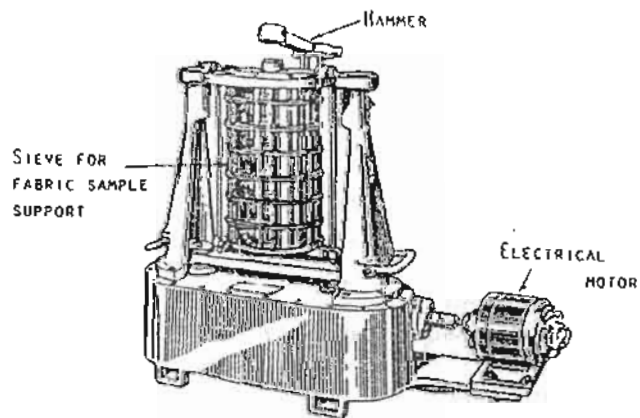

Fig. 2. Mechanical Sieving Apparatus.

Where  $r$  = radius of a capillary, meter

$S$  = surface tension of water,  $72.75 \times 10^{-3}$  Kg. sec<sup>2</sup>.

$\theta$  = contact angle between the liquid and the walls of capillary, degrees

$\rho$  = water density,  $1000$  Kg. m<sup>-3</sup>

$g$  = gravity acceleration,  $9.81$  m.sec<sup>-2</sup>

$h$  = height of rising liquid, meter.

Particularly, for a liquid that completely wets the walls of the capillary and for which, consequently,

$\theta = 0$  and  $\cos \theta = 1$ , hence.

$$r = 2S / \rho gh \quad \dots (3)$$

In order to determine the level of wetting of specimens, contact angle in degrees ( $\theta$ ) can be calculated as follows :

$$\theta = \arccos (r \cdot \rho \cdot g \cdot h / 2S) \quad \dots (4)$$

As should be expected, the height to which a liquid rises in a capillary (the capillary rise) grows with a decreasing radius of the capillary and with an increasing surface tension of the liquid. The height to which a liquid rises in a capillary (the capillary rise) depends on number of pores and their size.

(b) In the second technique of soil, different size classes of soil were successively sieved through a test specimen using a mechanical sieving apparatus (Figure 2). A sample of five hundred grams of soil was sieved. Retained soil weight on each sieve can be expressed as a cumulative percent by weight below the lower class limit. A model integral of this types  $F(r)$  is shown in Figures 3. The slope of the integral curve at any point represents the weight change per unit change in radius of sieve opening. The slope values are plotted against opening radius to produce the dashed differential curve  $f(r)$  in Figure 3, which represents the particle size distribution of the soil. Also a sample of fifty grams of soil was sieved for each class through a sample 20 cm in diameter for 10 minutes. The passage percentage of soil is plotted versus the soil size and is called dry sieving curve (DSC).

Afterwards, a sample of one hundred grams of the original soil including the different classes was sieved through each sample (20 cm in diameter) for 10 minutes and the passage percent of soil through each sample could be recorded and compared with that obtained at the intersection of the dry sieving curve and the integral curve of each fabric. Thus separation efficiency of geotextiles can be deduced.

## 4. RESULTS AND DISCUSSIONS

The geotextiles used in the study were nonwoven fabrics made of polyester fibres. Their main characteristics are presented in Table I. They represent a great range of mass per unit area (156-662 g/m<sup>2</sup>) and of pore radius (56-207 μk). And the fabric porosity ranges between 89.6% and 96.9%.

Table (I) : Characteristics of Nonwoven Geotextiles

Fabric No.	Fabric weight, g/m <sup>2</sup>	Thickness in mm at 34.5 g/cm <sup>2</sup>	Fabric density, 10 <sup>4</sup> g/cm <sup>3</sup>	Porosity, (%)	Pore radius, r, μk	Pore radius, r, μk
					(Eq.1)	(Eq.2)
1	209.9	3.193	657.5	95.2	150.0	143.0
2	203.6	3.130	650.4	95.3	152.4	142.8
3	661.7	4.593	1440.6	89.6	54.2	51.0
4	471.4	4.406	1070.0	92.2	145.0	127.5
5	561.1	4.206	1334.1	90.3	116.5	117.7
6	153.9	3.546	433.9	96.9	205.1	186.3
7	600.8	4.993	1203.3	91.3	145.4	113.8

The data obtained in the experiment are the height of liquid column and the weight of absorbed liquid by the multi-layers of fabrics after equilibrium period. If a more accurate assessment is required, a wet sample can be dried and its total liquid capacity can be determined from the weight loss. When this liquid is in very small pores, it usually represents a minor fraction of the total pore volume in the fabric. Pore radius could be measured using the two methods described earlier. The critical pore radius can be calculated in terms of applied pressure (Eq.1) or through Equation (2). The pore radius values for each fabric are presented in Table (1). It could be seen that the pore radius decreases with increasing mass per unit area.

Liquid content in each fabric can be expressed in absolute volume terms through the liquid density or as a fraction of the total content. A model integral curve of this type  $F(r)$  is shown in Figure (3). The slope of the integral curve at any point represents the volume change per unit change in  $(r)$ . The slope values are plotted against  $(r)$  to produce the dashed differential curve  $f(r)$  in Figure (3).

On the other hand, by using dry sieving method, passed soil weight from each sieve can be expressed as a cumulative percent by weight which represents the particle size distribution of the soil. The passage percent of the used soil sample is plotted versus the radius of sieve opening. Thus the integral and differential curves of the fabric samples and the used soil sample are plotted versus pore and opening radius respectively as shown in Figures (4-10). Also the integral curves of all the fabrics and

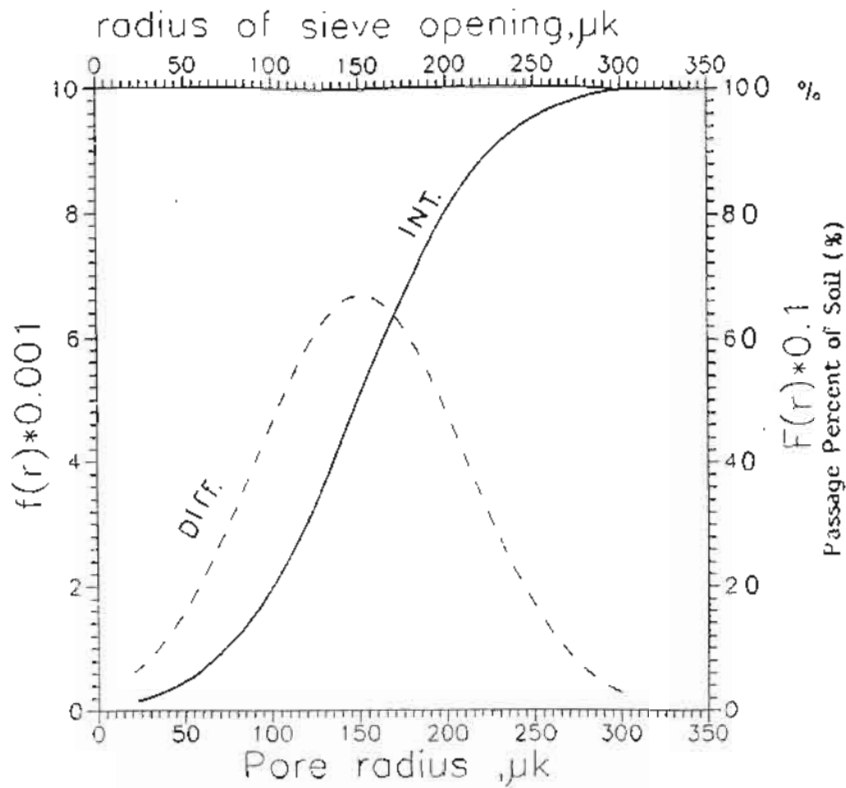

Fig. 3. Integral curve (solid) and Pore size distribution (dashed) for soil sample.

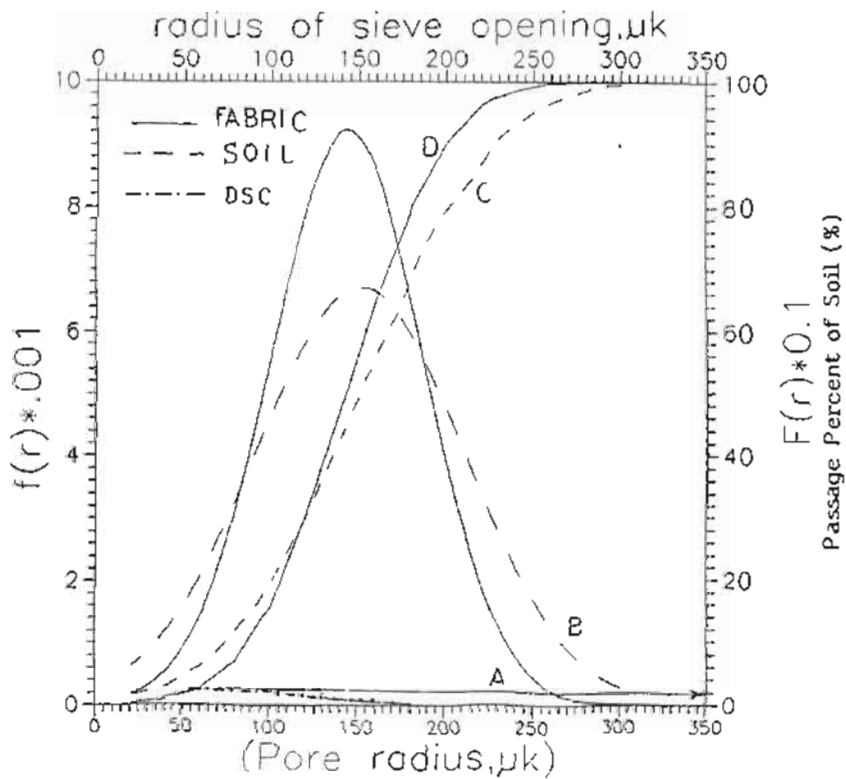

Fig. 4. Integral curves (C & D) and pore size distributions (A & B) for both fabric No.1 and soil.



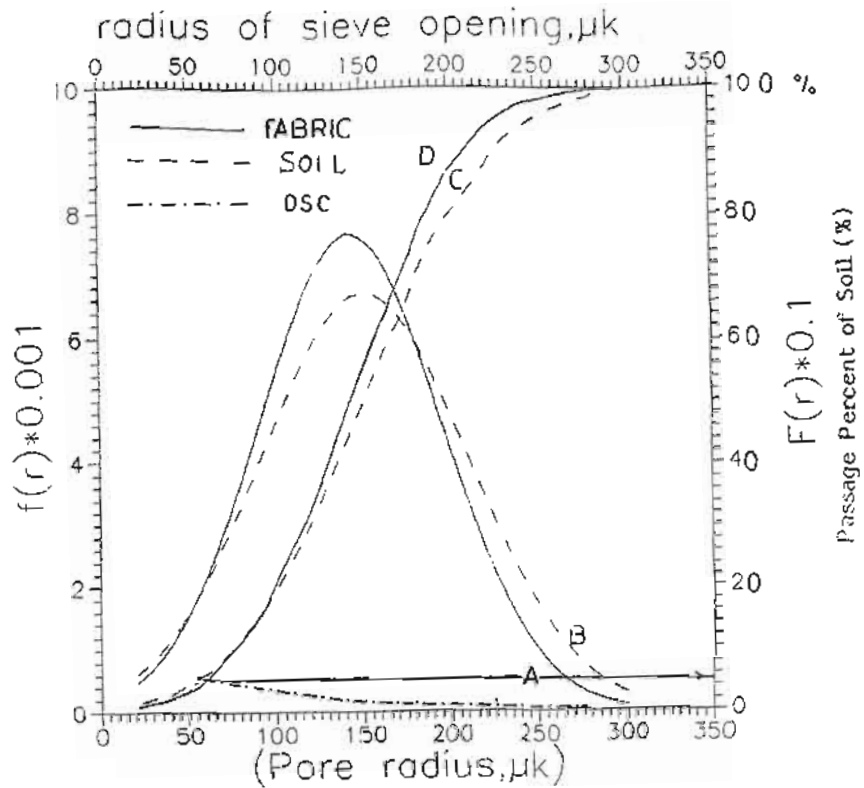

Fig. 5. Integral curves (C & D) and pore size distributions (A & B) for both fabric No. 2 and soil.

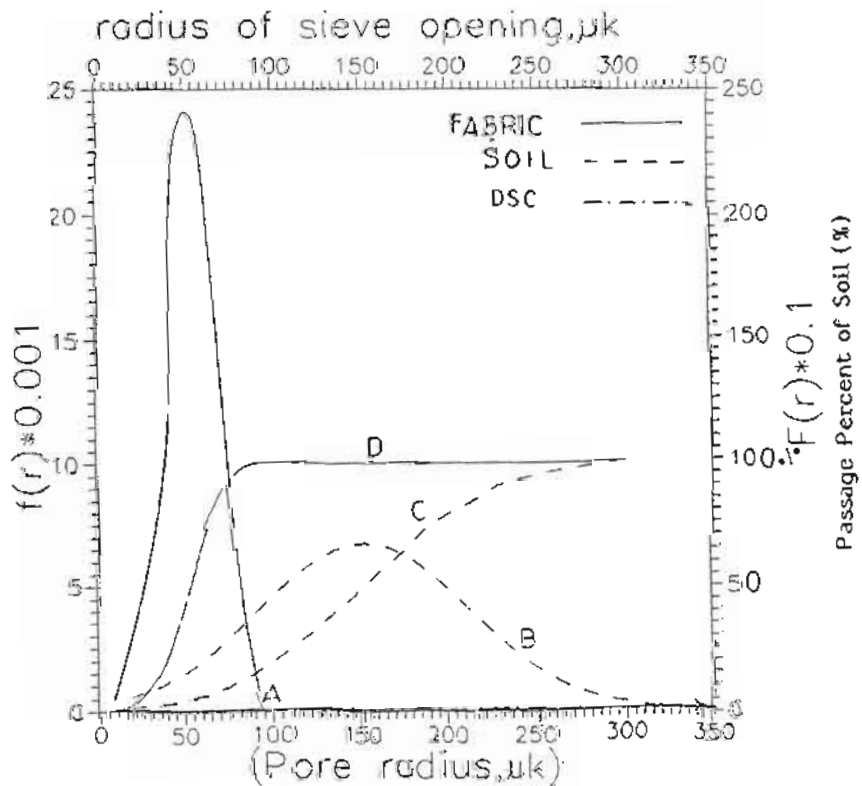

Fig. 6. Integral curves (C & D) and pore size distributions (A & B) for both fabric No. 3 and soil.

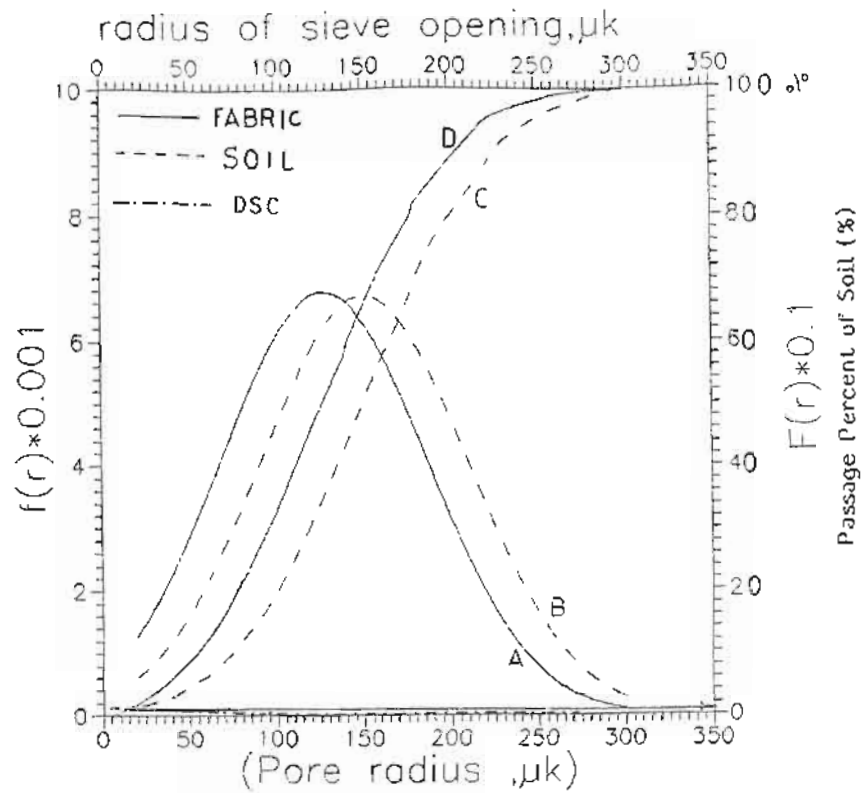

Fig. 7. Integral curves (C & D) and pore size distributions (A & B) for both fabric No. 4 and soil.

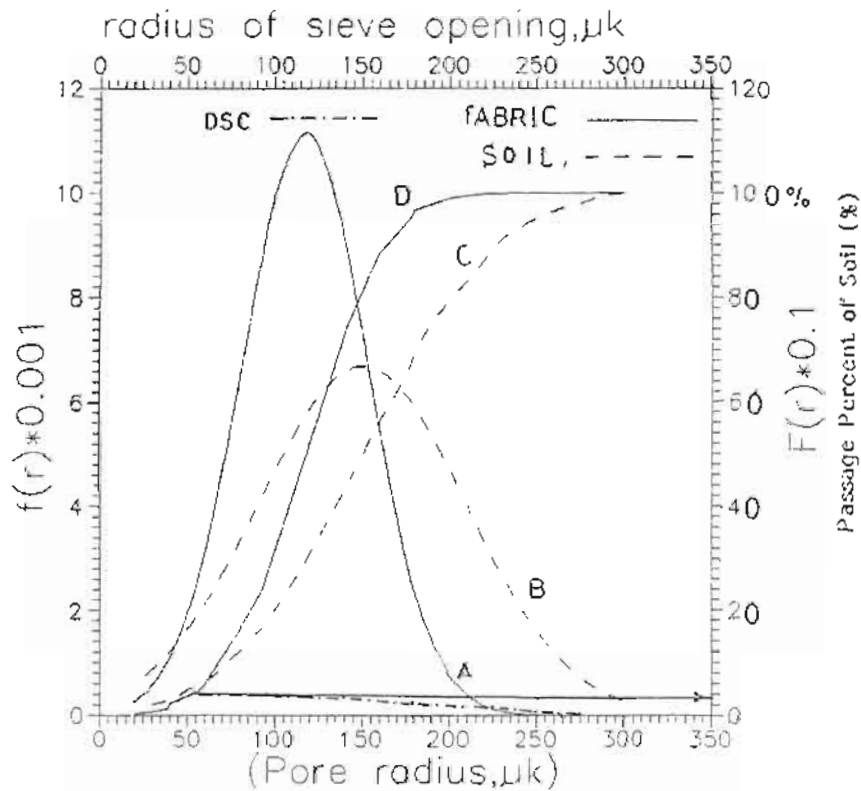

Fig. 8. Integral curves (C & D) and pore size distributions (A & B) for both fabric No. 5 and soil.

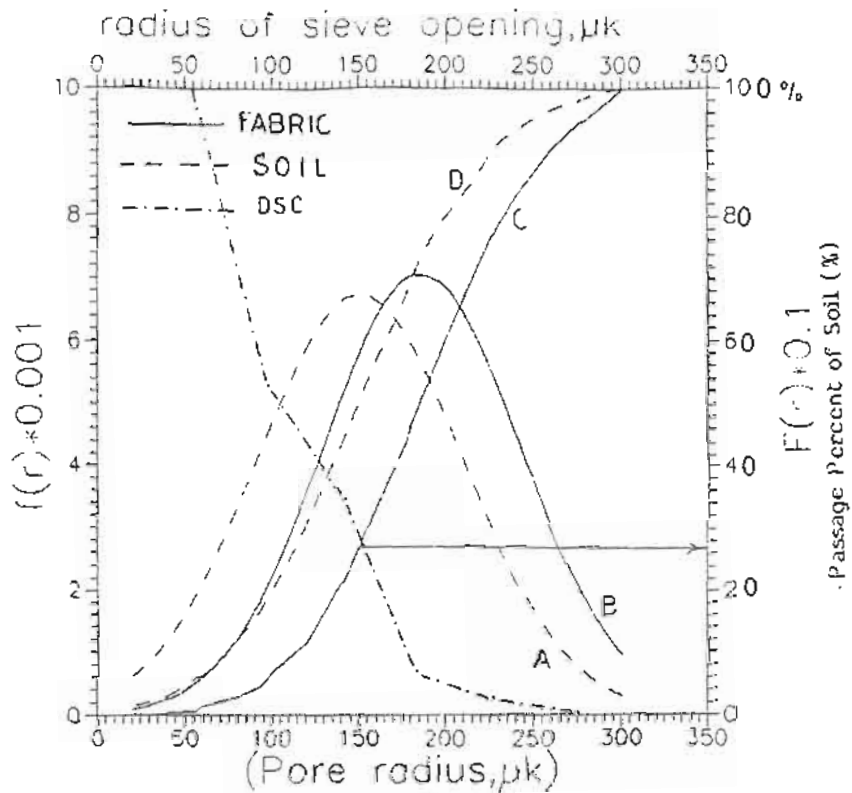

Fig. 9. Integral curves (C & D) and pore size distributions (A & B) for both fabric No. 6 and soil.

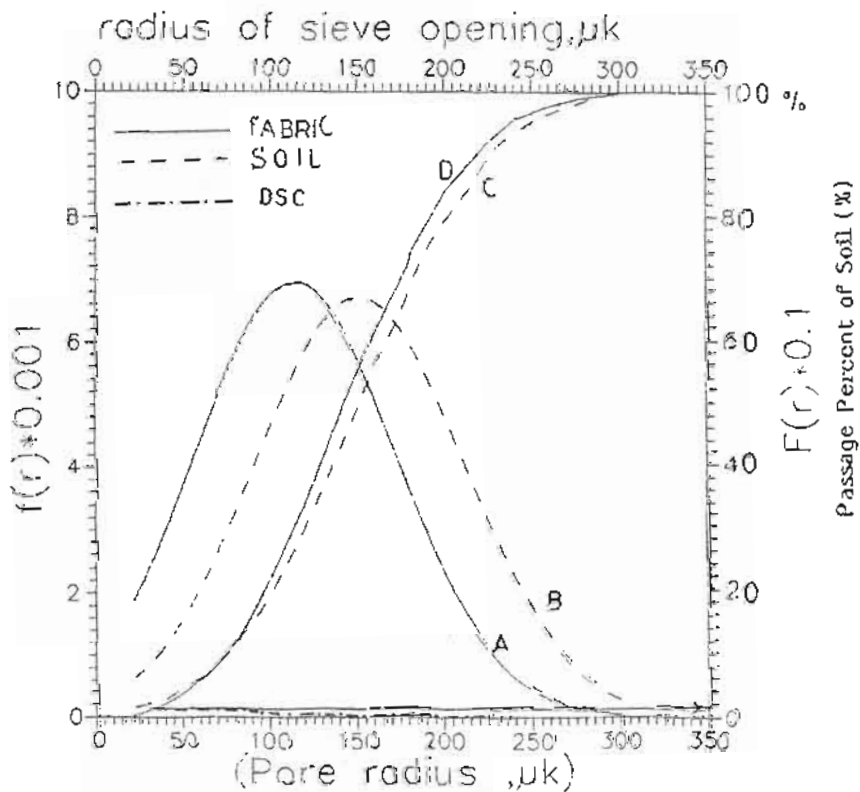

Fig. 10. Integral curves (C & D) and pore size distributions (A & B) for both fabric No. 7 and soil.

The soil are plotted together versus pore and opening radius respectively as shown in Figure (11). From Figure (11), it could be seen that Fabric No. 6 and fabric No. 3 has the lowest and highest soil separation efficiency respectively. Because at any pore radius of fabric No. 6, cumulative passage percent of soil (dashed line) is higher than the cumulative volume of pores in fabric No. 6. Conversely, for fabric No. 3 which cumulative passage percent of soil is lower than its pores volume.

The results of passage percent of fifty grams of soil in each size class through fabric samples are reported in Table II and plotted in Figures (4-10) and called dry sieving curves (DSC).

Table II : Passage Percent of Soil Through Fabrics

Sample	Class limit of soil size , $\mu$ k					
	>500	500 400	400 315	315 250	250 125	125 100
1	0	0	0	0.33	2.0	2.2
2	0.33	1.33	1.33	1.67	3.33	5.73
3	0	0	0	0	0	0
4	0	0	0	0	0.3	0.33
5	0	1.33	2.0	3.08	3.33	3.67
6	0	2.67	7.0	33.0	54.0	100
7	0	0	0.33	0.60	0.67	1.33

To assess soil separation efficiency of geotextile fabrics, dry sieving curves (DSC) could be plotted and intersected with the integral curves of fabrics. The intersection between them indicates the separation efficiency or passage percent of soil through the fabric. The observed and measured results of passage percent of the soil are presented in Table (III) and plotted in Figures (4-10).

The observed values of passage percent of soil through fabrics can be therefore considered to agree fairly close with the obtained experimental results.

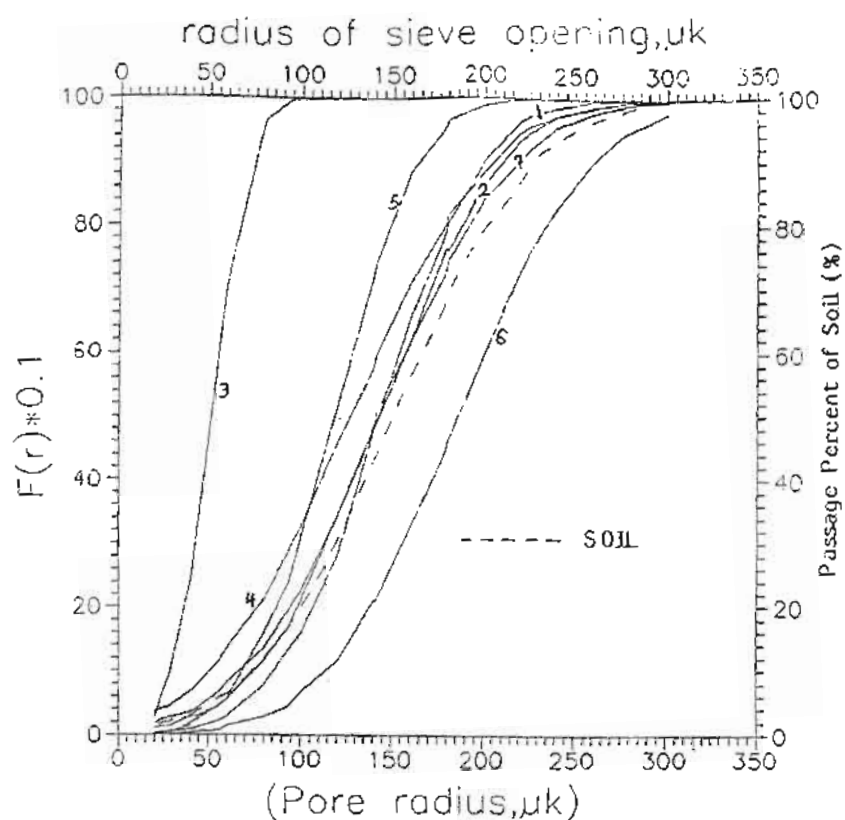

Fig. 11. Integral curves measured for seven geotextile fabrics (solid) and soil sample (dashed).

Table (III) : Comparison Between Observed and Measured Passage Percent of Soil Through Fabrics

Fabric Sample	Observed Value (from curves)	Measured Value (from sieving 100 gm of soil on fabrics)
1	2.0	2.97
2	5.0	4.40
3	0.0	0.00
4	1.0	1.10
5	3.67	3.20
6	26.5	25.40
7	1.33	1.60

### 5. CONCLUSION

Pore size distribution could be plotted from a knowledge of pore radius and volumetric absorbed water of multi-layers fabrics using a new technique. Also pore size distribution of soil could be obtained using particle size analysis. To assess soil separation efficiency of geotextile fabrics, dry sieving diagram of soil in each size class could be plotted. The intersection between the integral curve of fabric and dry sieving curve represents the separation efficiency or passage percent of soil through the fabric. The observed values of separation efficiency can therefore be considered to agree fairly close with the obtained experimental results.

### REFERENCES

1. Van Zanten V.R. and Balkema A.A., "Geotextiles and Geomembranes in Civil Engineering", Netherlands 1986.
2. Koerner R.M., "Designing with Geosynthetics", Prentice - Hall, 1986.
3. John Blackie N.W.M., "Geotextiles" 1987
4. Koerner R.M. and Welsh J.P., "Construction and Geotechnical Engineering using Synthetic Fabrics", Wiley International, 1980.
5. Falyse E., Rollin A., Rigo T.M. and Gourc J.P., Study of the Different Techniques used to Determine the Filtration Opening on Geotextiles, in "Proc. 2<sup>nd</sup> Canadian Symposium of Geotextiles and Geomembranes " Edmonton, Canada, September 1985, P. 45-50.
6. American Society for Testing and Materials, Standard Test Method : Test Method for water permeability of geotextiles by permittivity, D 4491-85.
7. Calhoun C.C., Development of Design Criteria and Acceptance Specifications for plastic Filter Cloths, Technical Report S.72.7, U.S.Army Engineer Water Ways Experiment Station, Vicksburg, Mississippi, June 1972.
8. Gerry B.S. and Raymond G.P., Equivalent Opening Size of Geotextiles, Geotech Testing J., 6, P.53-63, June 1983.
9. Ogink H.J.M., Investigations on the Hydraulic Characteristics of Synthetic Fabrics, Publication N.O. 146 of Waterloopkundig Laboratorium Delft Hydraulics Laboratory, May 1975.
10. Heerten G., Dimensioning the Filtration Properties of Geotextiles Considering Long Term Conditions in "Proc. 2<sup>nd</sup> International Conference on Geotextiles". Vol.1, Las Vegas, August 1982, P.115-120.
11. Fayoux D., Filtration Hydrodynamique des sols par les Textiles in "Comptes rendus du colloque International Sur L'Emploi des Textiles en Geotechnique", Vol. 2, Paris 1977, P.329- 332.
12. ISO Tests for geotextiles- porometry : Determination of the filtration aperture, ISO/TC 38/SC 21 NqE.
13. Brochier P., Comportement des Geotextiles en Filtration et en Separation, Maitrise es Sciences Appliquees, Ecole Polytechnique, Montreal. June 1984.

14. Masounave J., Rollin A. and Denis R., Prediction of Permeability of Nonwoven Geotextiles from Morphometry Analysis, *J. Microscopy* 121 (1), 99-110, January 1981.
15. Gong R.H. and Newton A., Image - analysis Techniques, Part I : The measurement of Pore - size Distribution, *J. Text. Inst.*, Vol. 83, No. 2, 1992, P. 253-268.
16. Bernard Miller and Ilya Tyomkin, An Extended Range Liquid Extrusion Method for Determining Pore Size Distribution, *Text. Res. J.*, Vol. 56, No. 1, 1986, P. 35 - 40.
17. Gerard Lombard and et al, theoretical and Experimental Opening Sizes of Heat - Bonded Geotextiles, *Text. Res. J.* Vol. 59, No. 4, 1989, P. 208 - 217.
18. Wei and et al, Permeability of Soil- Geotextile Systems, *Text. Res. J.*, Vol. 55, No. 10, 1985, P. 620 - 630.
19. Mc Cown and El-Shibini F.Z., Geotextiles and Related Materials, Conference 17<sup>th</sup> - 21<sup>th</sup> March 1990, Kuwait.
20. Abou- Taleb H.A., Theoretical Prediction of The Pore Size of Filter Fabrics, *The Indian Textile Journal*, November 1991, P. 42-47.
21. Kikoin A.K. and Kikoin I.K. *Molecular Physics*, Mir Publishers, Moscow, 1980.
22. Traekov B.C. and Polynovsky A.G., Determination of Porosity of Nonwoven Fabrics, *Technological Industry*, 1984, NO.4, p.65-67.