

12-1-2021

Elastic Behaviour and Analysis of Braced Domes.

Ahmed Badr

Associate Professor., Structural Engineering Department., Faculty of Engineering., El-Mansoura University., Mansoura., Egypt., profdrabadr@yahoo.com

Follow this and additional works at: <https://mej.researchcommons.org/home>

Recommended Citation

Badr, Ahmed (2021) "Elastic Behaviour and Analysis of Braced Domes.," *Mansoura Engineering Journal*: Vol. 18 : Iss. 4 , Article 2.

Available at: <https://doi.org/10.21608/bfemu.2021.166179>

This Original Study is brought to you for free and open access by Mansoura Engineering Journal. It has been accepted for inclusion in Mansoura Engineering Journal by an authorized editor of Mansoura Engineering Journal. For more information, please contact mej@mans.edu.eg.

ELASTIC BEHAVIOUR AND ANALYSIS OF BRACED DOMES

BY

Dr. AHMED E.A BADR.

Assoc. Prof. Struct Eng. Dept; El.Mansoura University

السلوك المرن وتحليل القباب المقواة

خلاصة

يستخدم المهندسون المعماريون و الإنشائيون القباب في تغطية المساحات الكبيرة لما لها من شكل جمالي بالإضافة الى انها اقتصادية في المواد المستخدمة في تنفيذها . والقباب المقواة تناسب تغطية المساحات الكبيرة مثل صالات الألعاب الرياضية وصالات المعارض وحمامات السباحة والممرات التجارية وقاعات الاجتماعات هذا بالإضافة الى المباني الصناعية حيث يتطلب الأمر مساحات كبيرة وتكلفة اقتصادية أقل ما يمكن . لهذا كان من الضروري دراسة سلوك وتحليل هذا النوع من المنشآت . حيث تم دراسة السلوك المرن والتحليل الإنشائي للقباب المقواة باستخدام نظرية العناصر الدقيقة . ففي هذا التحليل تم تقسيم المنشأ الى عناصر خطية عبارة عن الأعضاء المكونة لهذا الإنشاء حيث تتصل العناصر مع بعضها اتصال جسي . وتم تجهيز و اعداد البرنامج للاستخدام على الحاسب الآلى .

ABSTRACT

Large spans have always fascinated architects and engineers. Domes provide an easy and economic method of roofing Large areas and are used frequently by the designers who realize the advantages and the impressive beauty of this form of construction.

Domes are of special interest to engineers and architects as they enclose a maximum amount of space with a minimum surface and have proved to be very economic in the consumption of constructional materials. Domes are also exceptionally suitable for covering sports stadia, assembly halls, exhibition centers, swimming pools, shopping arcades, and industrial building in which large unobstructed areas are essential and where minimum interference from internal supports is required. The provision of unobstructed Sight-Lines for large numbers of people is the primary requirement in sports halls and can easily be satisfied through the adoption of a domical shape. In this paper The exact and approximate methods of analysis of domes are discussed.

1. INTRODUCTION

A braced dome may be defined as a skeletal structure whose geometric form is a part of a sphere and which is fabricated from members. Before any engineering Structure can be analyzed, it has to be represented by an idealized mathematical structure whose behaviour is sufficiently close to that of the original engineering structure. The idealizations available for braced dome structures fall into two distinct groups: the equivalent shell methods and the discrete structure methods.

The equivalent shell methods fall in turn into two sub-groups.

In the first sub-group, the analyst uses orthopedic shell theory. The orthotropic shell stiffness which occur in the theory are replaced by equivalent shell stiffness. These are calculated using approximations which aim to smear the effect of the discrete members uniformly over the surface of the equivalent shell.

In the second sub-group, difference expressions are set up by considering the stiffness of individual members. finite difference theory is then used in reverse to derive the governing differential equations of the equivalent shell from the difference equations.

All the equivalent shell methods lead to a set of governing differential equations. There are normally solved using a harmonic solution, but a conventional finite difference solution could be used or a finite element solution or even an equivalent skeletal structure.

In the second group of methods, the analyst tackles the discrete

structure directly. Within this group it is still necessary to select one of several possible idealizations. The principal choice is between a space truss analysis and a space frame analysis. There are also various non-linear effects which can and sometimes must be considered. The discrete structure methods led to a large set of simultaneous equations which can only be solved with the help of a computer.

The equivalent shell methods are best used in the early design stages and for structures which are too large to be analyzed as discrete structures. As computers become cheaper, the use of equivalent shell methods will certainly decrease.

2- BRACED DOME BEHAVIOUR

A shell dome resists loads with a force system acting in the surface of the shell. Typically, there will be a principal compressive force acting vertically in the surface of the dome and a lesser horizontal force (usually tensile) acting around the dome, as shown in Fig. (1).

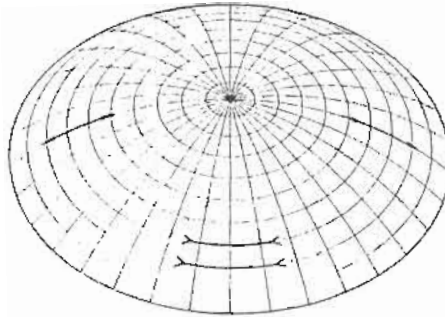

Fig.(1) Major stresses in a shell dome

The way a braced dome works depends on the configuration of the members. Braced domes which are fully triangulated, such as the dome in Fig. (2-a), will have a high stiffness in all directions in the surface of the dome. These configurations are also kinematically stable (no mechanisms) when idealized as a space truss. Accordingly, the forces in a fully triangulated dome will be principally axial and will have direction and magnitude similar to those in a shell dome.

A dome which is not fully triangulated is kinematically unstable when idealized as a truss and may also have widely different stiffness in different directions in the surface of the dome. The dome shown in Fig. (2-b) can only support loads by developing bending moments in the members and joints. The dome shown in Fig.(2-c) will require continuous joints or structural cladding to give the dome stability and to resist non-axisymmetric loading.

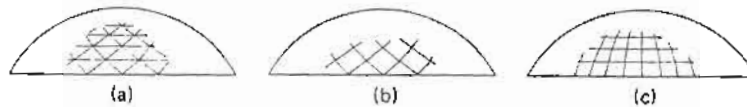

Fig.(2) Arrangement of bracing

3. ANALYSIS OF BRACED DOMES.

Analyses of braced domes can be divided into linear and non-linear. A simple linear elastic analysis in association with suitable permissible stresses can check for all types of local member (or joint) failure. These include yield, member buckling, fracture, fatigue and sliding at joints. The first yield load is also a lower bound on the shakedown load. However, to

check for instability effects involving more than one member or geometry change and also to exploit any post first yield strength that might be available in the structure, the designer must include non-linear effects in the analysis.

Non-linear effects can be divided into member effects such as plastic yielding and geometric effects.

Methods of non-linear analysis can be divided into three approaches.

The first is the plastic mechanism approach, which is not really applicable to braced domes.

The second is the stability approach, which involves the location of bifurcation points in a perfect structure. This approach can accommodate geometric but not member non-linearities.

The third is the incremental approach. In this approach, the load is applied in small increments. At each increment, the stiffness of the structure is re-calculated to accommodate changes in member stiffness, structure geometry, indeed all relevant non-linear phenomena. The structure is normally given assumed initial deformations and locked-in stresses to give a more representative analysis. Member non-linearities are accommodated by assuming a stress dependant member stiffness. The easiest to program is the elastic perfectly plastic case, where the member stiffness simply changes to zero. An improvement is the non-linear elastic case, which can model the falling force in a buckled member. Further sophistication can be obtained by modeling elasto-plastic flow using a yield criteria and flow rule containing the member stress resultants. Finally, the member can be subdivided into layers. Komatsu and Sakimoto[2] have produced stiffness for partially yielded closed sections, but generally there is need for further research in this area.

Geometric non-linearities can be critical in braced domes; in particular, with shallow or unevenly loaded domes, it may be essential to check for snap-through buckling. Geometric non-linearity will be covered later on other paper

For many braced domes a space truss idealization will be sufficient. A space truss analysis can incorporate both member and geometric non-linearity. A full space frame analysis is only required for structures which have a significant bending action, such as non-triangulated domes, domes with continuous curved members and possibly some very shallow single-layer domes.

4- THE STIFFNESS METHOD.

The stiffness method is usually used to analyze a structure which is an arbitrary assembly of simple structural members. The stiffness method is sometimes referred to as the displacement method. There is a second method for tackling the same problem called the flexibility or force method, but this latter method is not widely used.

Consider the simple elastic bar shown in Fig.(3). The bar has stiffness $k=EA/L$, end forces p_1 and p_2 and end displacements d_1 and d_2

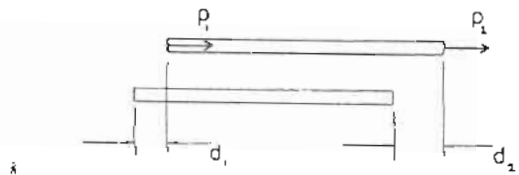

Fig.(3) End forces and displacements

The end forces can be expressed as a linear combination of the end displacements as follows;

$$kd_1 - kd_2 = p_1, \quad -kd_1 + kd_2 = p_2 \quad (1)$$

The analysis requires a large amount of linear algebraic manipulation and the most suitable branch of mathematics for representing such manipulations is matrix algebra. In addition to being ideally suited to computer implementation,

If the displacement at one end and either a force or the displacement at the other end are known, then the set of Eqns. (1) can be used to calculate the remaining forces and displacements.

Therefore, set of Eqns. (1) can be expressed in matrix form as follows,

$$\begin{bmatrix} K & -K \\ -K & K \end{bmatrix} \begin{bmatrix} d_1 \\ d_2 \end{bmatrix} = \begin{bmatrix} P_1 \\ P_2 \end{bmatrix} \quad \text{or } K.d = P \quad (2)$$

where ; K is the member stiffness matrix ,
 d and p are the member displacement and force vector.

It is obvious that the stiffness method can be used to generate a stiffness matrix for an arbitrary assembly of simple members. Consider for example, the structure shown in Fig.(4). The stiffness matrix for the complete structure is constructed such that the first row is the equilibrium equation for the first Joint and so on for all rows.

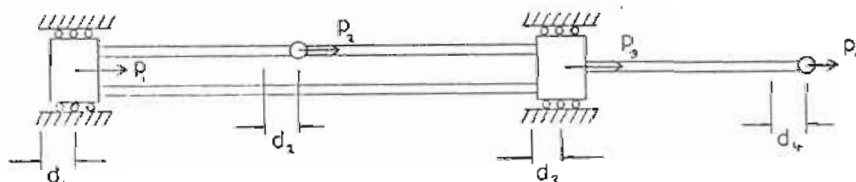

Fig.(4) An assembly of bar elements

The equations can be expressed as a simple matrix equation;

$$\begin{bmatrix} K_a + K_b & -K_a & -K_b & 0 \\ -K_a & K_a + K_c & -K_c & 0 \\ -K_b & -K_c & K_b + K_c + K_d & -K_d \\ 0 & 0 & -K_d & K_d \end{bmatrix} \begin{bmatrix} d_1 \\ d_2 \\ d_3 \\ d_4 \end{bmatrix} = \begin{bmatrix} P_1 \\ P_2 \\ P_3 \\ P_4 \end{bmatrix} \quad (3)$$

Inspection of Eq.(3) shows that the contents of the member stiffness matrices are added to the structure stiffness matrix in positions which correspond to the location of the member in the physical structure. For example, member B connects joint 1 to joint 3 and accordingly the contents of member stiffness K_b can be found in the first and third rows and columns of the structure stiffness matrix.

After the structure stiffness matrix has been assembled, some sort of solution procedure such as computer program can be used to evaluate the unknown displacements and forces after the known displacements and forces have been specified.

4.1 FORM STIFFNESS MATRIX OF A STRUCTURE

The first step towards forming the structure stiffness matrix is to form the primary stiffness matrix. This is composed of member stiffness submatrices, of which there are four per member. These submatrices K_{11}, K_{12}, K_{21} and K_{22} relate the forces applied to the ends of the member to

the displacements of those ends. K_{11} and K_{22} are known as the direct stiffness submatrices, as they relate the forces and displacements at the same end of a member. K_{12} and K_{21} are known as the cross stiffness submatrices, as they relate the forces applied to one end of a member to the resulting displacements at the other end. The derivation of the terms in these matrices will not be discussed here, as they are readily available from the many texts that now exist on the subject of matrix methods of structural analysis [4,5,6,7,9]. The terms of the member stiffness submatrices are; for a typical member b

$$K_{11b} = \left[\begin{array}{ccc|ccc} EA_b/l_b & 0 & 0 & 0 & 0 & 0 \\ 0 & 12EI_{zb}/L_b^3 & 0 & 0 & 0 & 6EI_{zb}/L_b^2 \\ 0 & 0 & 12EI_{yb}/L_b^3 & 0 & -6EI_{yb}/L_b^2 & 0 \\ \hline 0 & 0 & 0 & CJ_b/L_b & 0 & 0 \\ 0 & 0 & -6EI_{yb}/L_b^2 & 0 & 4EI_{yb}/L_b & 0 \\ 0 & 6EI_{zb}/L_b^2 & 0 & 0 & 0 & 4EI_{zb}/L_b \end{array} \right] \quad (4)$$

$$K_{22b} = \left[\begin{array}{ccc|ccc} EA_b/L_b & 0 & 0 & 0 & 0 & 0 \\ 0 & 12EI_{zb}/L_b^3 & 0 & 0 & 0 & -6EI_{zb}/L_b^2 \\ 0 & 0 & 12EI_{yb}/L_b^3 & 0 & 6EI_{yb}/L_b^2 & 0 \\ \hline 0 & 0 & 0 & CJ_b/L_b & 0 & 0 \\ 0 & 0 & 6EI_{yb}/L_b^2 & 0 & 4EI_{yb}/L_b & 0 \\ 0 & -6EI_{zb}/L_b^2 & 0 & 0 & 0 & 4EI_{zb}/L_b \end{array} \right] \quad (5)$$

$$\begin{matrix}
 K_{12b} = \\
 K_{21b}^T =
 \end{matrix}
 \left[\begin{array}{ccc|ccc}
 -EA_b/L_b & 0 & 0 & 0 & 0 & 0 \\
 0 & -12EI_{zb}/L_b^3 & 0 & 0 & 0 & 6EI_{zb}/L_b^2 \\
 0 & 0 & -12EI_{yb}/L_b^3 & 0 & -6EI_{yb}/L_b^2 & 0 \\
 \hline
 0 & 0 & 0 & -GJ_b/L_b & 0 & 0 \\
 0 & 0 & 6EI_{yb}/L_b^2 & 0 & 2EI_{yb}/L_b & 0 \\
 0 & -6EI_{zb}/L_b^2 & 0 & 0 & 0 & 2EI_{zb}/L_b
 \end{array} \right] \quad (6)$$

where

- E = modulus of elasticity
- L = Length of the member
- I_y = maximum principal second moment of area
- I_z = minimum principal second moment of area
- J = torsion constant of the cross-section of the member
- G = modulus of rigidity
- A = Cross sectional area

and $G = \frac{E}{2(1+\nu)}$ where ν is poisson's ratio

These matrices are formed with respect to the member coordinate system, to which the following assumptions apply:

- a) The number allocated to joint i is always smaller than that of joint j
- b) The member is of uniform cross-section
- c) The member axis $O_m X_m$, Fig (5), is passing through the centroid of the cross-section, with its positive direction from i to j
- d) The axes $O_m Y_m$ and $O_m Z_m$ are along the principal axes of the second moments of area of the cross-section such that the second moment of area about $O_m Y_m$ is the maximum
- e) The positive directions of $O_m Y_m$ and $O_m Z_m$ are such that $O_m X_m Y_m Z_m$ is a right-handed cartesian coordinate system and that the projection of $O_m Z_m$ on $O_g Z_g$ (global axis, Fig.(6)) is always positive

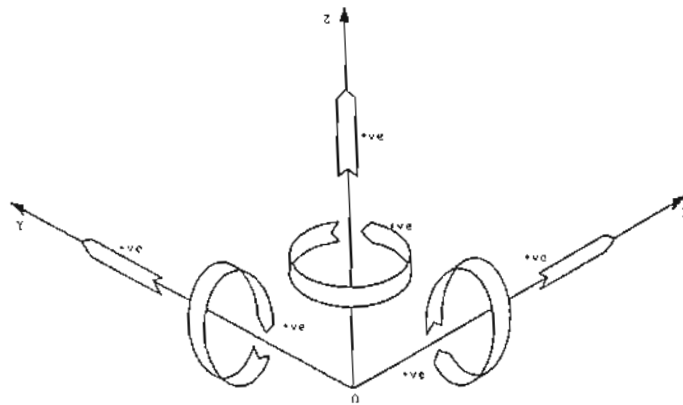

Fig.(5) Sign convention for right-handed Cartesian coordinate systems

The four member stiffness submatrices have been shown partitioned into submatrices of order 3, and computer time can be saved by evaluating only the required submatrices K_A, K_B, K_C and K_D .

$$K_{11} = \begin{bmatrix} K_A & K_C^T \\ K_C & K_B \end{bmatrix} \quad (8)$$

$$K_{22} = \begin{bmatrix} K_A & -K_C^T \\ -K_C & K_B \end{bmatrix} \quad (9)$$

$$K_{12} = K_{21}^T = \begin{bmatrix} -K_A & K_C^T \\ -K_C & K_B \end{bmatrix} \quad (10)$$

Where, for a typical member b,

$$K_{A_b} = \begin{bmatrix} \frac{EA_b}{L_b} & 0 & 0 \\ 0 & \frac{12EI_{z_b}}{L_b^3} & 0 \\ 0 & 0 & \frac{12EI_y}{L_b^3} \end{bmatrix} \quad (11)$$

$$K_{B_b} = \begin{bmatrix} \frac{GJ_b}{L_b} & 0 & 0 \\ 0 & \frac{4EI_{yb}}{L_b} & 0 \\ 0 & 0 & \frac{4EI_{z_b}}{L_b} \end{bmatrix} \quad (12)$$

$$K_{C_b} = \begin{bmatrix} 0 & 0 & 0 \\ 0 & 0 & \frac{-6EI_{yb}}{L_b^2} \\ 0 & \frac{6EI_{z_b}}{L_b^2} & 0 \end{bmatrix} \quad (13)$$

$$K_{D_b} = \begin{bmatrix} \frac{-GJ_b}{L_b} & 0 & 0 \\ 0 & \frac{2EI_{yb}}{L_b} & 0 \\ 0 & 0 & \frac{2EI_{z_b}}{L_b} \end{bmatrix} \quad (14)$$

Another right-handed cartesian coordinate system $O_g-X_g-Y_g-Z_g$ is the coordinate system for the whole structure and is referred to as the global coordinate system. Before the member stiffness submatrices can be assembled to form the primary stiffness matrix, they must be transformed such that they are all in terms of the global coordinate system as opposed to being in their own member coordinate systems. This is done by carrying out the following linear transformations.

a) THE MEMBER IS NON-VERTICAL WITH RESPECT TO THE GLOBAL COORDINATE SYSTEM

for this case, an additional right-handed cartesian coordinate system, The auxiliary co-ordinate system $O_a-X_a-Y_a-Z_a$ must be introduced and is constructed such that O_m-X_m and O_a-X_a are coincident and O_a-Y_a is parallel to the $O_g-X_g-Y_g$ plane as shown in fig.(6) The angle between O_m-Y_m and O_a-Y_a , angle α is measured from O_m-Y_m to O_a-Y_a and is positive if it drives a right-handed screw along the positive direction of O_m-X_m .

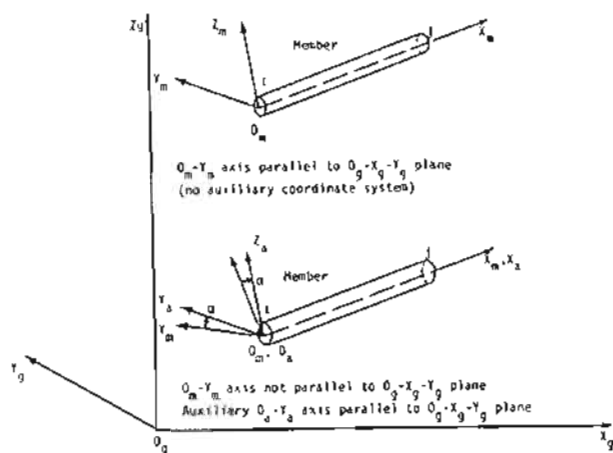

Fig. (6) Global and member coordinate systems (non-vertical members)

A transformation matrix of order 3, matrix R , is used to transform each of the four submatrices of order 3 of the member stiffness submatrices from the member coordinate system to the auxiliary coordinate system

$$R = \begin{bmatrix} 1 & 0 & 0 \\ 0 & \cos \alpha & \sin \alpha \\ 0 & -\sin \alpha & \cos \alpha \end{bmatrix} \quad (15)$$

The transformation from the auxiliary to the global coordinate system will now be considered. Again a transformation matrix of order 3, matrix P , is used

$$P = \begin{bmatrix} a & -bd & -acd \\ b & ad & -bcd \\ c & 0 & 1/d \end{bmatrix} \quad (16)$$

$$a = \frac{x_{gj} - x_{gi}}{L} \quad (17)$$

$$b = \frac{y_{gj} - y_{gi}}{L} \quad (18)$$

Where;

$$c = \frac{z_{gj} - z_{gi}}{L} \quad (19)$$

$$d = \frac{1}{\sqrt{a^2 + b^2}} \quad (20)$$

These being the components of a unit vector along O_m-X_m (and O_a-X_a) relative to the global coordinate system. x_{gi} , x_{gj} , y_{gi} , y_{gj} , z_{gi} and z_{gj} are the coordinates of member ends i and j relative to the global coordinate system and L is the length of the member.

Letting A be any sub-matrix of order 3 of the member stiffness submatrices, the required transformation from member to global coordinate system is

$$A_g = P.R.A_m.R^{-1}.P^{-1} \quad (21)$$

but since both transformation matrices P and R are orthogonal matrices, the transformation can be written as;

$$A_g = P.R.A_m.R^T.P^T \quad (22)$$

It should be noted that if angle $\alpha = 0$, $R = I$, a unit matrix, and the

transformation can be simplified to

$$A_g = P.A_m.P^T \tag{23}$$

If the member ij is parallel with O_g-X_g , $P = I$, a unit matrix, and the transformation can be simplified to;

$$A_g = R.A_m.R^T \tag{24}$$

If both P and R are unit matrices, no transformation is required, i.e.,

$$A_g = A_m \tag{25}$$

b) THE MEMBER IS VERTICAL WITH RESPECT TO THE GLOBAL COORDINATE SYSTEM

For this case, the values of the terms, a, b, c and d in Eqns.(16) to (20) will be $a = b = 0$, $c = \pm 1$ and $d = \infty$, therefore the matrix P is not defined. To obtain an equivalent matrix, an angle β has to be introduced, as shown in Fig (7). β is the angle between the positive directions of O_g-X_g and O_m-x_m and is positive if it drives a right-handed screw along O_g-Z_g . The transformation matrix P then becomes ;

$$P = \begin{bmatrix} 0 & \cos \beta & -c \sin \beta \\ 0 & \sin \beta & c \cos \beta \\ c & 0 & 0 \end{bmatrix} \tag{26}$$

The required transformation on any submatrix A of order 3 is then

$$A_g = P.A_m.P^T \tag{27}$$

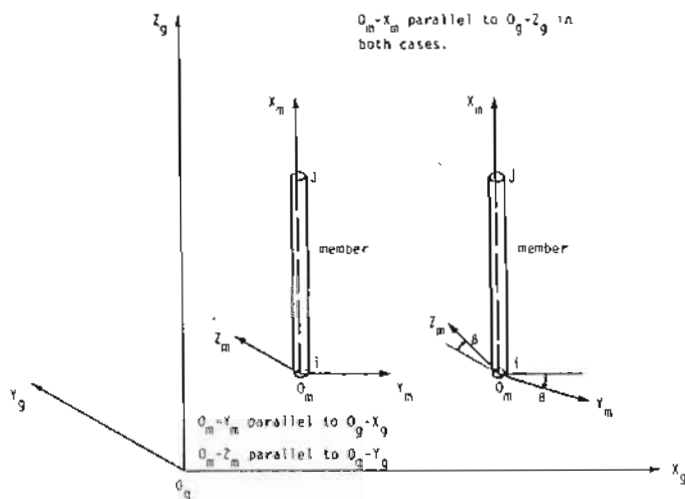

Fig.(7) Global and member coordinate systems (vertical members)

Once these transformations have been carried out on the member stiffness submatrices, they can be assembled to form the primary stiffness matrix K . For any member b, the position of the member stiffness is shown in Fig (8) and, for a typical structure, the assembly of the whole primary stiffness matrix is shown in Fig(9).

It should be remembered that; for a computer program, as the program stores only the lower diagonal portion of the matrix, only K_{21} and the lower

diagonal submatrices of K_{11} and K_{22} need be planted into the primary stiffness matrix.

The primary stiffness matrix \bar{K} must now be modified to produce the structure stiffness matrix K , which involves the implementation of constraint conditions. If, however, any of the constrained joints are nonconformable, i.e., the joint coordinate system does not correspond with the global coordinate system, a further linear transformation is required. A joint coordinate system is constructed which is again a right-handed cartesian coordinate system. In the computer program, allowance is made for rotation of X_n and Y_n axes about the Z_n axes, i.e. the horizontal joint coordinate axes may be rotated about the vertical axis.

The angle between O_g-X_g and O_n-X_n , angle γ in Fig (10), is measured from O_g-X_g to O_n-X_n and is positive if it drives a right-handed screw along the positive direction of O_g-Z_g .

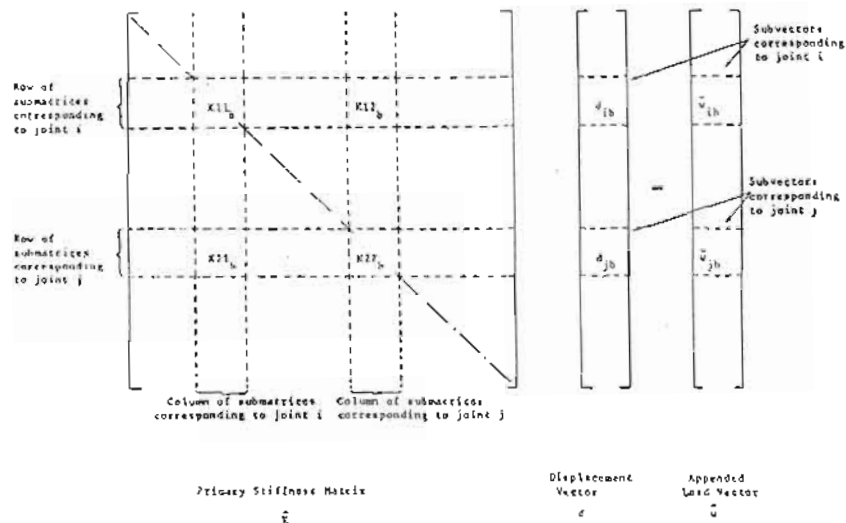

Fig.(8) Primary stiffness matrix, displacement vector and appended load vector

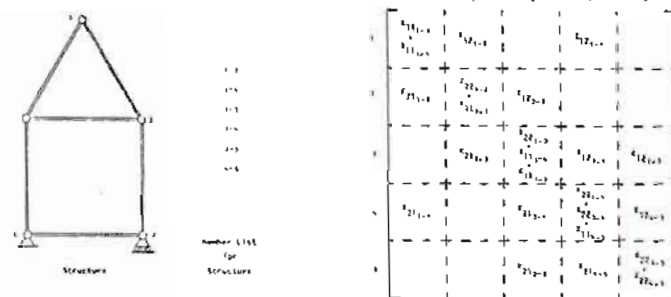

Fig.(9) Arrangement of member stiffness submatrices in primary stiffness matrix K

The required transformation matrix of order 3, matrix S, is

$$S = \begin{bmatrix} \cos \gamma & \sin \gamma & 0 \\ -\sin \gamma & \cos \gamma & 0 \\ 0 & 0 & 1 \end{bmatrix} \quad (28)$$

this matrix is the transformation matrix for rotation of the X_n and Y_n joint axes about Z_n . Similarly for rotation of X_n and Z_n axes about Y_n , matrix S would be;

$$S = \begin{bmatrix} \cos \gamma & 0 & \sin \gamma \\ 0 & 1 & 0 \\ -\sin \gamma & 0 & \cos \gamma \end{bmatrix} \quad (29)$$

where angle γ is measured from $O_g Y_g$ to $O_n Y_n$, and for rotation of the Y_n and Z_n axes about X_n , matrix S would be

$$S = \begin{bmatrix} 1 & 0 & 0 \\ 0 & \cos \gamma & \sin \gamma \\ 0 & \sin \gamma & \cos \gamma \end{bmatrix} \quad (30)$$

where angle γ is measured from $O-Z$ to $O-Z$.

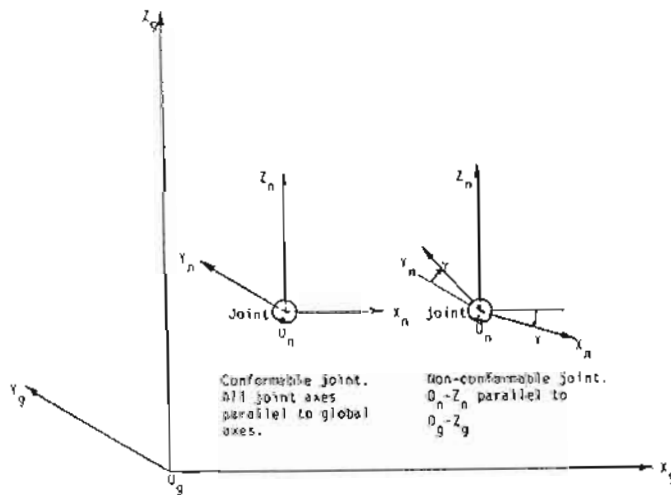

Fig.(10) Global and joint coordinate systems

The method of transformation from global to Joint coordinate systems described below is best carried out on the assembled primary stiffness matrix. Each joint in the structure has six row submatrices of order n associated with it in the primary stiffness matrix (n being the order of the stiffness matrix) which can be considered as a 6*n submatrix lying horizontally across the stiffness matrix. Similarly, each joint has six column submatrices of order n associated with it, which can be considered as an nx6 submatrix lying vertically in the stiffness matrix. At the intersection of these two submatrices, a common submatrix of order 6 exists

which lies on the diagonal of the primary stiffness matrix.

For any nonconformably constrained joint, take the $6 \times n$ submatrix and partition into submatrices of order 3. Letting a typical submatrix be A_r , the required transformation is of the form

$$A_{rn} = S \cdot A_{rg} \quad (31)$$

i.e. all such submatrices should be premultiplied by the transformation matrix S. Similarly, partitioning the $n \times 6$ sub-matrix into square submatrices of order 3, typically A_c , the transformation is of the form;

$$A_{cn} = A_{cg} \cdot S^T \quad (32)$$

i.e. all such submatrices should be post-multiplied by the transpose of matrix S. From this it can be seen that the four square submatrices of order 3, A_d , which make up the submatrix of order 6 lying on the diagonal of the stiffness matrix have each undergone a transformation of the form.

$$A_{dn} = S \cdot A_{dg} \cdot S^T \quad (33)$$

Again note that only the lower diagonal portion of the stiffness matrix is stored by the computer program, and that is in variable band form, so the submatrices will not be $6 \times n$ and $n \times 6$ but typically less than $6 \times 1/2 n$ and $1/2 n \times 6$ resulting in considerably fewer matrix multiplications.

The portion of the vertical $n \times 6$ submatrix may not even be continuous from top to bottom- see Fig.(11).

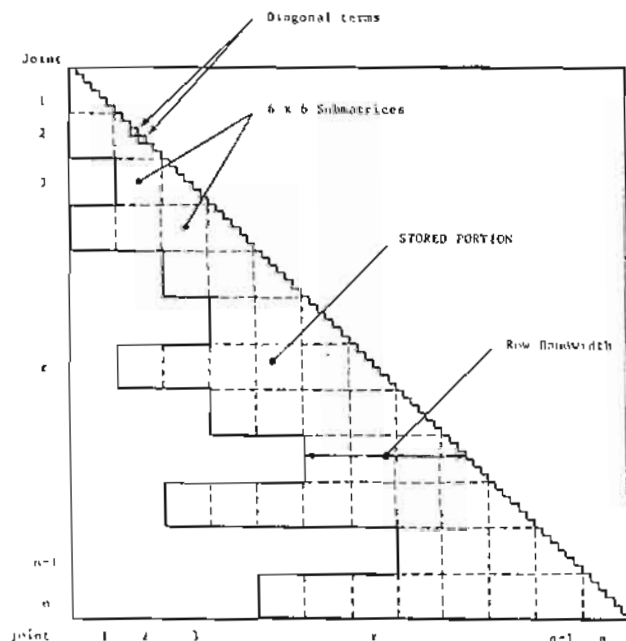

Fig.(11) Storage of stiffness matrix in variable band form

Also, the common sub-matrix lying on the diagonal of the stiffness matrix

will have been stored as a lower triangular matrix of order 6 rather than a square matrix of that order.

It may be seen that the use of nonconformable constraints is very limited, but it can be used to great effect in the analysis of symmetric structures by a reduction in the overall size of the problem, [8].

The stiffness matrix is now transformed to the various joint coordinate systems and the constraints may now be implemented, but first an additional step is carried out by the computer program. The decomposition of the stiffness matrix, for which see later, incorporates a singularity check and values for this check are evaluated at this stage. The values used are the means of the leading diagonal terms of the matrix for each degree of freedom that an individual joint has. Having obtained these six means, they are then divided by a suitable value (in the computer program the divisor used is 10^6) and stored. Also at this stage, the leading diagonal terms of the matrix are output to a file to allow checking of the matrix.

The final step in modifying the primary stiffness matrix to the structure stiffness matrix may now be carried out. This involves the implementation of constraints. Consider the equation

$$\bar{k}.d = \bar{w} \tag{34}$$

which contains no information regarding the manner in which the structure is supported, and \bar{w} contains components of reaction which are, as yet, unknown. Let δ_s be the s^{th} element of d and additionally let it correspond

to a constraint at a support. It can be seen that: $\delta_s = 0$ (35)

and this condition must be imposed on $\bar{k}.d = \bar{w}$.

Partitioning $\bar{k}.d = \bar{w}$, such that the s^{th} row and column of \bar{k} and the corresponding elements of d and \bar{w} become separated from the rest of the system.

$$\begin{bmatrix} \bar{K}_{aa} & \bar{K}_{as} & \bar{K}_{ab} \\ \bar{K}_{sa} & \bar{K}_{ss} & \bar{K}_{sb} \\ \bar{K}_{ba} & \bar{K}_{bs} & \bar{K}_{bb} \end{bmatrix} \begin{bmatrix} d_a \\ \delta_s \\ d_b \end{bmatrix} = \begin{bmatrix} \bar{w}_a \\ r_s \\ \bar{w}_b \end{bmatrix} \tag{36}$$

where r_s is the component of reaction at the constraint. Eq.(36) may be represented by three equations.

$$\bar{K}_{aa} d_a + \bar{K}_{as} \delta_s + \bar{K}_{ab} d_b = \bar{w}_a \tag{37}$$

$$\bar{K}_{sa} d_a + \bar{K}_{ss} \delta_s + \bar{K}_{sb} d_b = r_s \tag{38}$$

$$\bar{K}_{ba} d_a + \bar{K}_{bs} \delta_s + \bar{K}_{bb} d_b = \bar{w}_b \tag{39}$$

Substituting the constraint condition from Eq.(35) into the above three equations gives.

$$\bar{K}_{aa} d_a + \bar{K}_{ab} d_b = \bar{w}_a \tag{40}$$

$$\bar{K}_{sa} d_a + \bar{K}_{sb} d_b = r_s \tag{41}$$

$$\bar{K}_{ba} d_a + \bar{K}_{bb} d_b = \bar{w}_b \tag{42}$$

Equation (41) expresses the condition to be satisfied such that the displacement at the s^{th} degree of freedom is consistent with the overall equilibrium and compatibility of the structure. After substitution of the constraint condition, Eqns. (40) and (42) have been modified to include the requirement $\delta_s = 0$, but Eq.(41) relates displacements to the reactive component r_s , with which we are not concerned, so this equation can and should be omitted from the system. This leaves Eqns (40) and (42), which can be combined in the matrix equation.

$$\left[\begin{array}{c|c} \bar{k}_{aa} & \bar{k}_{ab} \\ \hline \bar{k}_{ba} & \bar{k}_{bb} \end{array} \right] \begin{bmatrix} d_a \\ d_b \end{bmatrix} = \begin{bmatrix} \bar{w}_a \\ \bar{w}_b \end{bmatrix} \quad (43)$$

Comparing this equation with Eq.(36), it can be seen that, in effect, all terms associated with S have been removed. As regards the computer program, to carry out such an action would be an extremely time consuming chore, so an alternative method is adopted as shown by the matrix equation;

$$\left[\begin{array}{c|c|c} \bar{K}_{aa} & 0 & \bar{K}_{ab} \\ \hline 0 & x & 0 \\ \hline \bar{K}_{ba} & 0 & \bar{K}_{bb} \end{array} \right] \begin{bmatrix} d_a \\ \delta_s \\ d_b \end{bmatrix} = \begin{bmatrix} \bar{w}_a \\ 0 \\ \bar{w}_b \end{bmatrix} \quad (44)$$

The condition $\delta_s = 0$ is still satisfied, but instead of deleting a row and column of the matrix and a term in each vector and then 'closing up' the matrix and vectors, the off-diagonal elements of the s th row and column of K and the s th element of w have been replaced by zero and at the intersection of the s th row and column in K the element has been replaced with a non-zero number x . x need only be unity, but in this program it is taken as a large number, i.e. 10^{50} . The reason for using such a large number will be explained later in the next article of matrix decomposition. Once this modification has been carried out for all constrained degrees of freedom, the matrix has been fully modified to the structure stiffness matrix which relates displacements to external loads only, by the equation

$$K d = w \quad (45)$$

4.2 DECOMPOSE STIFFNESS MATRIX.

Having formed the structure stiffness matrix, the system of simultaneous equations $k d = w$ must be solved and the first step towards this is to decompose the matrix. The computer program used in this research uses the CHOLESKI method of decomposition which is ideally suited to the task for a number of reasons. It should be noted that CHOLESKI decomposition is only suitable for positive definite, symmetric matrices and the stiffness matrix is of this type. This method will decompose a matrix A such that;

$$A = L.L^T, \quad (46)$$

where L is a lower triangular matrix and, as its transpose, L^T is an upper triangular matrix. From this it can be seen that only one of these two is required as the other can be simply obtained from it. As the computer program stores the lower triangular portion of the stiffness matrix, it is the lower triangular matrix L which is stored, L occupying the same storage space after decomposition as the stiffness matrix did before decomposition.

The equations governing this method of decomposition are;

$$l_{ii} = \sqrt{a_{ii} - \sum_{k=1}^{i-1} l_{ik}^2} \quad (47) \quad \text{for elements on the diagonal, and}$$

$$l_{ij} = \frac{a_{ij} - \sum_{k=1}^{j-1} l_{ik} l_{jk}}{l_{jj}} \quad (i > j) \quad (48) \quad \text{for the off-diagonal elements}$$

The elements on the diagonal have their square root taken due to the fact

that they are the product of the diagonal terms of L and L^T , i.e. l_{ii}^2 and only L (hence l_{ii}) is required. The decomposition is carried out row by row from top to bottom. During the decomposition, prior to having its square root taken, each pivot is output to a file and is checked to determine whether the matrix should be considered singular. If the pivot for a particular degree of freedom is found to be less than the singularity check value (i.e. one millionth of the mean of diagonal elements for that degree of freedom), the matrix is considered singular and execution of the program is halted. This explains why, when a constraint is applied to the stiffness matrix, a large value (10^{50}) as opposed to unity is placed on the diagonal.

4.3 INPUT LOAD DATA AND FORM LOAD VECTOR.

In the computer program A some what different and simpler approach is adopted when forming the load vector w to that used in forming the stiffness matrix K . Whereas with the stiffness matrix, \bar{K} was formed and then modified to K , with the load vector, \bar{w} cannot be formed due to the fact that it contains unknown components of reaction. Loading for a single-load case are read into the the load vector, these loads being in terms of the global coordinate system. This vector now contains all the loads applied to the structure for the load case in question, including loads applied to degrees of freedom which are to be constrained, but obviously no components of reaction. Two steps only are now required to modify this vector to the load vector w . The first of these steps is concerned with non-conformable constraints and the second is the implementation of the constraints.

If a joint in the structure is nonconformably constrained, the elements of the load vector associated with that joint must be transformed to that joint's coordinate system, just as the elements of the stiffness matrix associated with that joint were transformed. There will be six terms in the load vector associated with any joint i , these being;

$$w_i = \begin{bmatrix} P_{ix} \\ P_{iy} \\ P_{iz} \\ m_{ix} \\ m_{iy} \\ m_{iz} \end{bmatrix} \quad (49)$$

The upper three terms corresponding to applied forces in the X,Y and Z directions and the lower three terms corresponding to applied moments. Letting b be a subvector of order 3 corresponding to either the upper or lower three terms of w_i , the required transformation becomes..

$$b_n = S \cdot b_0 \quad (50)$$

where; S is the same transformation matrix as used in transforming the stiffness matrix (Eqns. 28, 29 or 30).

The loads applied to a non-conformable joint will now be in terms of that joint's coordinate system.

Once this transformation has been carried out for all non-conformable joints, the constraints may be implemented on the load vector. Eqns (34 to 44) explain the principle involved, but in addition to simply setting the required terms of the load vector to zero, any forces externally applied to a constrained degree of freedom will become reactions of the same magnitude and opposite sign to that of the applied force. Therefore, before a

constrained degree of freedom is set to zero, the value of that element of the load vector should be transferred to a reaction vector where its sign should be changed. For example, if a joint i is constrained against vertical movement and is loaded with a vertically downward force $-P_{ix}$, a vertically upward reaction of $+P_{ix}$ will be induced. When all constraints have been implemented, the load vector is fully modified to w and the system is ready to be solved.

4.4 SOLVE SYSTEM AND EVALUATE DISPLACEMENTS.

The system $Kd=w$ is now ready to be solved to determine the unknown nodal displacements. Expressing $Kd=w$ in general terms.

$$A.x = b \quad (51) \quad \text{where } A \text{ has been decomposed to } L.L^T, \text{ i.e.}$$

$$L.L^T.x = b \quad (52)$$

The solution can now be carried out in two distinct stages.

$$\text{let } L.L^T.x = Y \quad (53) \quad \text{then } LY = b \text{ (solve for } y) \quad (54)$$

$$\text{and } L^T.x = Y \text{ (solve for } x) \quad (55)$$

Hence the displacements are evaluated and, in the computer program, they are stored in the same space as the load vector was before solution. This is possible as the load vector is no longer required.

If any joints in the structure are nonconformably constrained, the elements of the displacement vector associated with those joints will have been evaluated in terms of the various joint coordinate systems and must now be transformed back to the global coordinate system. There will be six terms in the displacement vector associated with any joint i , these being;

$$d_i = \begin{bmatrix} \delta_{ix} \\ \delta_{iy} \\ \delta_{iz} \\ \theta_{ix} \\ \theta_{iy} \\ \theta_{iz} \end{bmatrix} \quad (56)$$

The upper three terms corresponding to translations in the X,Y and Z directions and the lower three terms corresponding to rotations. Letting b be a subvector of order 3 corresponding to either the upper or lower three terms of d_i , the required transformation becomes.

$$b_g = S^{-1}.b_n \quad (57)$$

where S is the same transformation matrix as before (Eq.(28), 29 or 30)) It can be seen that this transformation is the inverse of that used to transform elements of the load vector from the global to the joint coordinate system in Eq.(50), but as the matrix S is orthogonal, the transformation may be written as;

$$b_g = S^T.b_n \quad (58)$$

After all such transformation have been carried out, the displacement vector is in terms of the global coordinate system and the displacements are output to the displacement data file.

4.5 EVALUATE MEMBER FORCES AND REACTIONS

The first step towards evaluating member forces is again to form the member stiffness submatrices K_A, K_B, K_C and K_D as in Eqns (11), (12), (13), and (14). These are formed in the member coordinate system, which is of course the coordinate system in which the member forces should be evaluated to be meaningful. These submatrices relate forces at the ends of a member to the displacements of those ends, so it follows that, as the member forces are required in the member coordinate system, the displacements should also be in that coordinate system. This means that for each member, the elements of the displacement vector associated with the two ends of the member must be transformed from the global to the relevant member coordinate system. This is the inverse of the transformation used to transform the member stiffness submatrices from the member to the global coordinate system, but as the transformation matrices are orthogonal the transpose of the matrix rather than its inverse may be used. The transformation applied to a typical subvector b of order three associated with end i of a member can therefore be written as:

$$b_{im} = R^T \cdot P^T \cdot b_{ig} \quad (59) \quad \text{for non vertical members, noting that;}$$

$$R^T \cdot P^T = (PR)^T \quad (60)$$

$$\text{and } b_{im} = P^T \cdot b_{ig} \quad (61) \quad \text{for vertical members.}$$

In Eq.(59), matrix R is as given in Eq.(15) and matrix P is as given in Eq.(16), in Eq.(61) matrix P is as given in Eq.(26).

With both member stiffness submatrices and joint displacement subvectors now in terms of the member coordinate system, the member forces can now be evaluated for a typical member b by using the relationships.

$$P_{ib} = K_{11b} d_{ib} + K_{12b} d_{jb} \quad (62)$$

$$P_{jb} = K_{21b} d_{ib} + K_{22b} d_{jb} \quad (63)$$

where P_{ib} and P_{jb} are the member end force vectors for member ends i and j respectively and d_{ib} and d_{jb} are the joint displacement subvectors for joints i and j . The form of these vectors is

$$P_{ib} = \begin{bmatrix} P_{ibx} \\ P_{iby} \\ P_{ibz} \\ \text{---} \\ m_{ibx} \\ m_{iby} \\ m_{ibz} \end{bmatrix} \quad P_{jb} = \begin{bmatrix} P_{jbx} \\ P_{jby} \\ P_{jbz} \\ \text{---} \\ m_{jbx} \\ m_{jby} \\ m_{jbz} \end{bmatrix} \quad d_{ib} = \begin{bmatrix} \delta_{ibx} \\ \delta_{iby} \\ \delta_{ibz} \\ \text{---} \\ \theta_{ibx} \\ \theta_{iby} \\ \theta_{ibz} \end{bmatrix} \quad d_{jb} = \begin{bmatrix} \delta_{jbx} \\ \delta_{jby} \\ \delta_{jbz} \\ \text{---} \\ \theta_{jbx} \\ \theta_{jby} \\ \theta_{jbz} \end{bmatrix} \quad (64) \quad (65) \quad (66) \quad (67)$$

The vectors P each containing three components of force and three components of moment and the vectors d containing three components of translation and three components of rotation. Having thus evaluated the forces in a member, they are output to the member forces file, but before going on to the next member, the current member should be checked to see whether either end is subject to a constraint. IF a member end is subject to

a constraint, then the forces at that end of the member should be transformed to the global coordinate system using the transformations .

$$b_g = p.R.b_m \quad (68) \quad \text{for non-vertical members} \quad \text{and}$$

$$b_g = P b_m \quad (69) \quad \text{for vertical members,}$$

where b is a subvector of order three of the member-end force vector for the constrained end of the member, and the transformation matrices P and R are the same as for previous transformations.

When this step has been carried out for all members connected to the constrained joint , and the results have been summed, the resulting vector, the constrained member-end force vector, contains the forces applied to the constrained joint by the members in the global coordinate system. If the joint is conformably constrained, these values may now be added to the reaction vector for that joint, which already contains any external loads applied to constrained degrees of freedom. If, however, the joint is non-conformably constrained, the values already in the reaction vector will be in terms of the joint coordinate system and therefore the forces applied to the joint by the members must be transformed to the joint coordinate system before being added to the reaction vector. letting b be a subvector of order three of this constrained member-end force vector, the required transformation is

$$b_n = S.b_g \quad (70)$$

where the transformation matrix S is the same as for previous transformations. The resulting vector may now be added to the reaction vector, which will now be complete and for a typical constrained joint i will be of the form.

$$r_i = \begin{bmatrix} P_{ix} \\ P_{iy} \\ P_{iz} \\ m_{ix} \\ m_{iy} \\ m_{iz} \end{bmatrix} \quad (71)$$

which contains three components of force and three of moment. If any of the degrees of freedom associated with the joint are not constrained, then the value of reaction for that degree of freedom will be zero due to equilibrium being satisfied. The reactions can now be output to the reaction data file. If there are any more load cases to be solved, the program now repeats sections 4.3,4.4 and 4.5 for each load case.

5. RESULTS.

After the analysis, the contents of the output data files are as follows,

- a) The member lengths data file contains the length of each member
- b) The joint displacement data file contains displacements in the form of three translations and three rotations per joint in terms of the global coordinate system.
- c) The member end forces data file contains three forces and three moments for each end of each member in terms of the member co-ordinate system for each member. Space can be saved in this file by listing three forces and three moments at one end of the member and two moments at the other. As all loads are applied at joints, the following values are all that are required:

$$F_{xi} \quad (=-F_{xj}) \quad , \quad F_{yi} \quad (=-F_{yj}) \quad , \quad F_{zi} \quad (=-F_{zj}) \quad , \quad M_{xi} \quad (=-M_{xj})$$

$$M_{yi} \quad , \quad M_{yj} \quad , \quad M_{zi} \quad , \quad M_{zj}$$

- d) The reaction data file contains three reactive forces and three moments at each constrained joint in terms of the joint coordinate system for each joint. Generally, the joint coordinate system will be coincident with the global coordinate system (i.e. for all conformably constrained joints) but will differ for nonconformably constrained joints.
- e) The matrix data file contains the leading diagonal terms of the primary stiffness matrix and the mean value of each of the six degrees of freedom per joint. These mean values divided by the singularity check value are also contained in the file, as are the pivotal values during decomposition of stiffness matrix.

The output from the computer graphics is shown in Figs.12 and 13-30. The dome shown in Figs 12-30 is a shallow spherical dome having a span of 40 m and a rise of 5 m. It is subdivided into six spherical isosceles triangles, each of which is further sub-divided eight times. Figure 12 shows the general arrangement of the structure. This dome was analyzed using the implementation of the analysis described in this paper. The loading applied to the structure was a combination of a dead load of 0.5 KN/m² proportional to the surface area of the dome and an imposed load of 0.75 KN/m² on plan, both distributed proportionally between all the joints. The dome was analyzed for two different support conditions: first, having six supports, the six joints at the ends of the main ribs, and secondly, having 48 supports i.e. all perimeter joints. In each case, the joints were constrained against x,y and z translations but free to rotate. The results of the analysis for the first support condition are shown in Figs. 13-21 and for the second support condition the results are shown in Figs -22-30

6. CONCLUSIONS

An attempt has been made in this paper to present method for the solution of skeletal systems as applied to braced domes. The designer however, should have no real difficulty in deciding upon a satisfactory arrangement and then carrying out a structural analysis.

This paper gives a step-by-step description of the operation necessary to carry out an analysis of structural systems. The method of analysis described is the finite element stiffness method, a popular and widely used technique which is ideally suited to implementation on a digital computer. The steps detailed in this paper are those required for a linear static analysis of elastic structural systems comprising prismatic members connected at fully rigid joints. Such skeletal systems may be considered as belonging to a particular class of structure within the field of finite element analysis in that idealization of the structure into elements is coincident with the members of that structure.

REFERENCES

- (1) Allen H.C. and Bulson, P.S. (1980). 'Background to Buckling' McGraw Hill book.
- (2) Blessman, J. (1971). 'Pressure on domes with several wind profiles' proc. 3rd Int. conf. 'wind Effecton Buildings and Structures' Tokyo, 1971, 313-326.
- (3) Crisfield, M.A. (1981) 'Computers and structures'13, pp. 55-62(4) Jennings, A. (1977). 'Matrix computation for engineers and scientists' J.wiley
- (5) Kardestuncer, H. (1974) 'Elementary matrix analysis of structures' Mc Graw-Hill. book

- (6) livesely, R.K. (1975). 'Matrix methods of structural analysis' 2nd Edn, pergmon press.
- (7) Meek, J.t. (1971) 'Matrix structural analysis, McGraw-Hill book'
- (8) Nooshin, H (1966) 'A technique for the analysis of structures having partially constrained Joints' Civ. Eng public wks Rev., 61, May, pp. 544.607
- (9) Przemieniecki, J.S. (1968). 'Theory of matrix structural analysis' McGraw-Hill book.
- (10) Roberts, G. (1951). 'The structural design of the dome of Discovery' Festival of Britain, 1951, proc. Inst. Civ. Eng., 3777-417.
- (11) Stevens, D.E. and Odom, G.S. (1965). 'The steel formed dome in space forms in steel' American Institute of steel construction, 33-41.
- (12) wright, D.T. (1965). 'Membrane forces and buckling in reticulated' shells, j. struct Div., Am Soc. Civ. Eng., 91 (ST5), 173. 211.

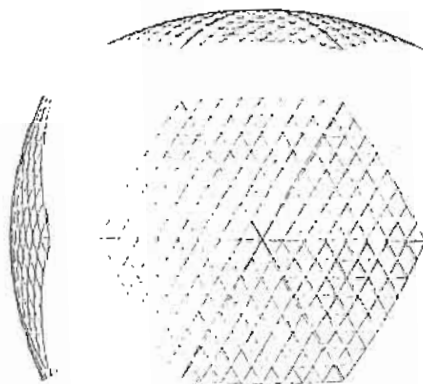

GENERAL ARRANGEMENT OF STRUCTURE

Fig. (12)



DISPLACEMENTS: Nodal Translations along Global x-axis
Fig. (13)

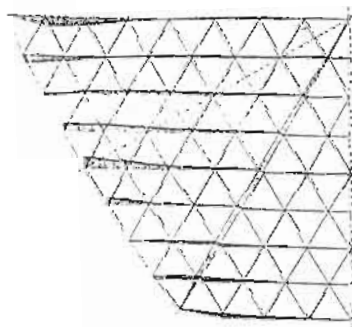

SCALE: 2.0 mm: 1.0 mm Displacement
DISPLACEMENTS: Nodal Translations along Global y-axis

Fig. (14)

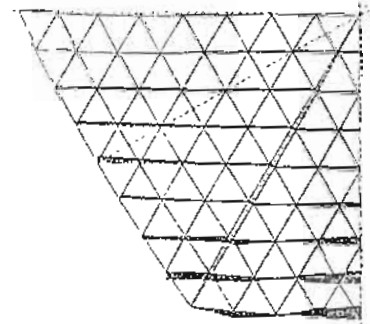

SCALE: 0.8 mm: 1.0 mm Displacement
DISPLACEMENTS: Nodal Translations along Global z-axis
Fig. (15)

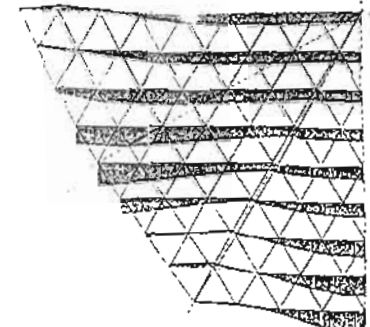

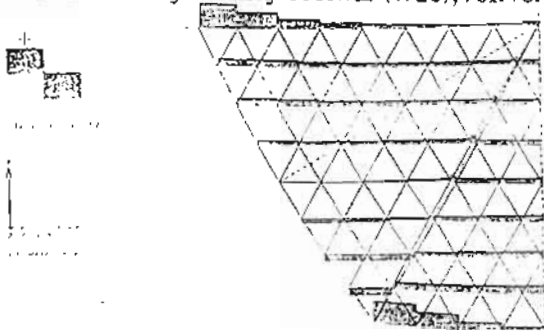

SCALE: 0.5 mm: 1.0 KN Force
 Forces: Member end Forces along Member x-axis
 (Axial Forces)

Fig. (16)

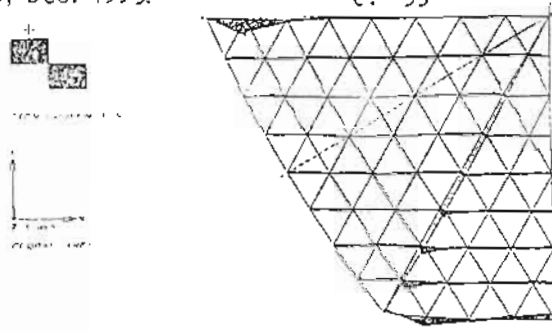

SCALE: 0.8 mm: 1.0 KN.m Moment
 MOMENTS: Member end Moments about Member y-axis
 (Bending Moments)

Fig. (20)

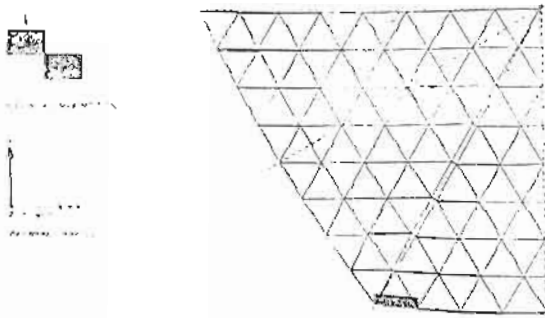

SCALE: 2.0 mm: 1.0 KN Force
 Forces: Member end Forces along Member y-axis
 (Shear Forces)

Fig. (17)

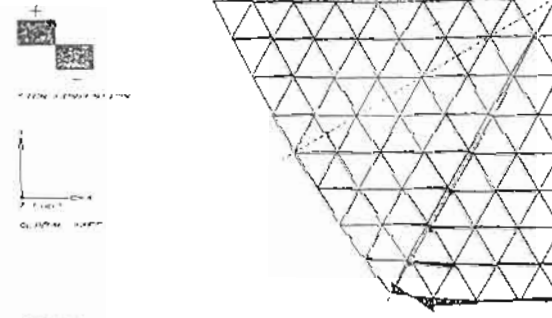

SCALE: 2.0mm: 1.0 KN.m Moment
 MOMENTS: Member end Moments about Member x-axis
 (Bending Moments)

Fig. (21)

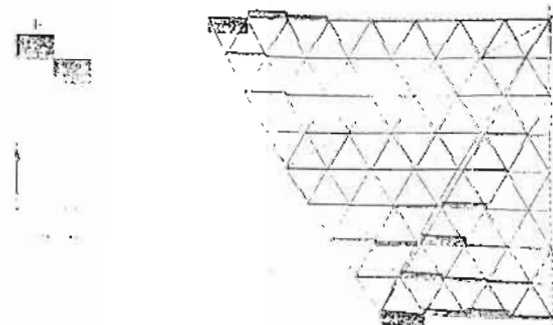

SCALE: 2.0 mm: 1.0 KN Force
 Forces: Member end Forces along Member z-axis
 (Shear Forces)

Fig. (18)

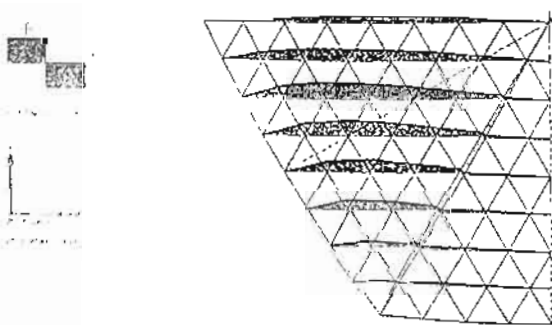

SCALE: 10.0 mm: 1.0 mm Displacement
 DISPLACEMENTS: Nodal Translations along Global x-axis

Fig. (22)

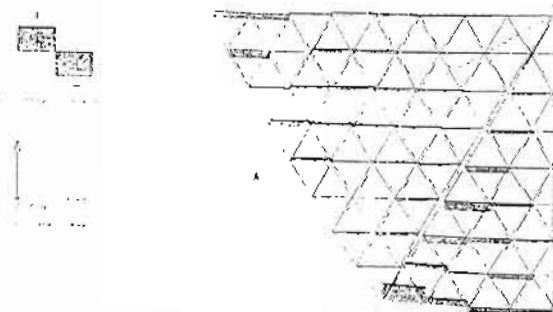

SCALE: 5.0 mm: 1.0 KN.m Moment
 MOMENTS: Member end Moments about Member x-axis
 (Torsional Moments)

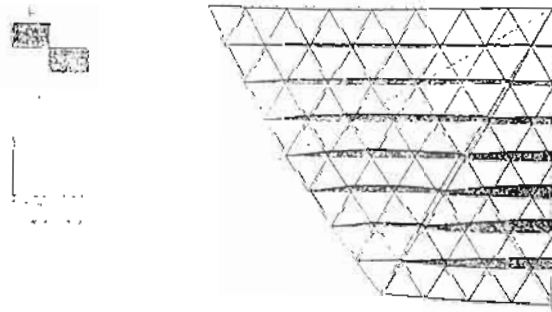

SCALE: 8.0 mm: 1.0 mm Displacement
 DISPLACEMENTS: Nodal Translations along Global y-axis

C. 34 Dr. AHMED E.A BADR.

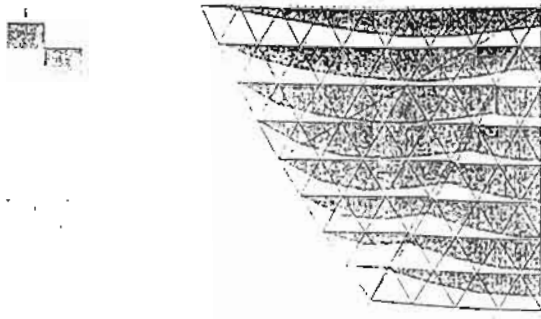

SCALE: 5.0 mm: 1.0 mm Displacement
DISPLACEMENTS: Nodal Translations along Global z-axis

Fig. (24)

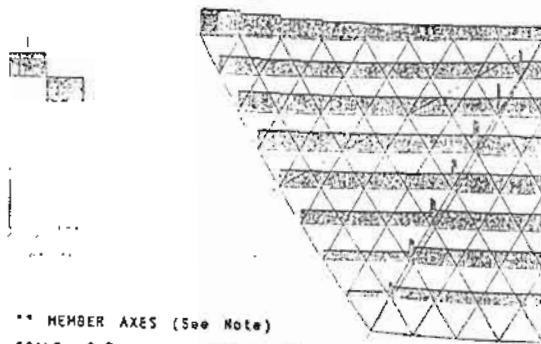

** MEMBER AXES (See Note)
SCALE: 0.2 mm: 1.0 KN Force
FORCES: Member end Forces along Member x-axis
(Axial Forces)

Fig. (25)

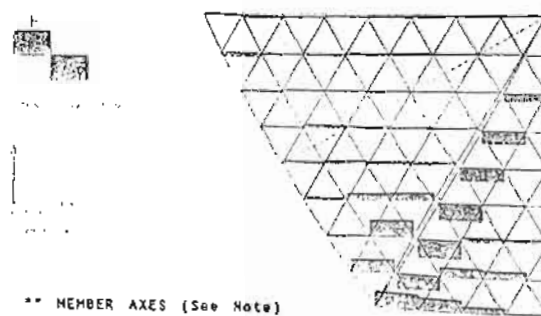

** MEMBER AXES (See Note)
SCALE: 50.0 mm: 1.0 KN Force
FORCES: Member end Forces along Member y-axis
(Shear Forces)

Fig. (26)

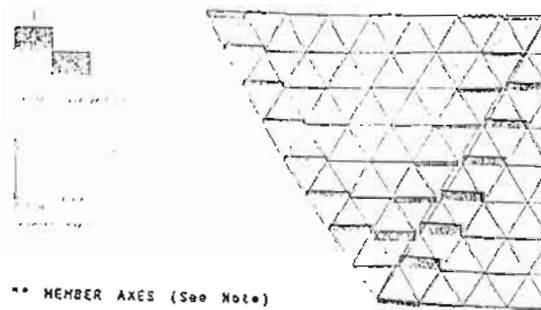

** MEMBER AXES (See Note)
SCALE: 10.0 mm: 1.0 KN Force
FORCES: Member end Forces along Member z-axis
(Shear Forces)

Fig. (27)

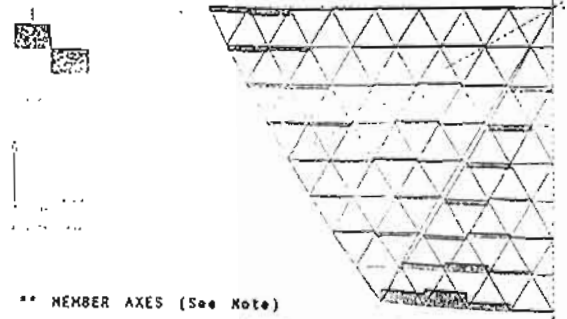

** MEMBER AXES (See Note)
SCALE: 20.0 mm: 1.0 KN.m Moment
MOMENTS: Member end Moments about Member x-axis
(Torsional Moments)

Fig. (28)

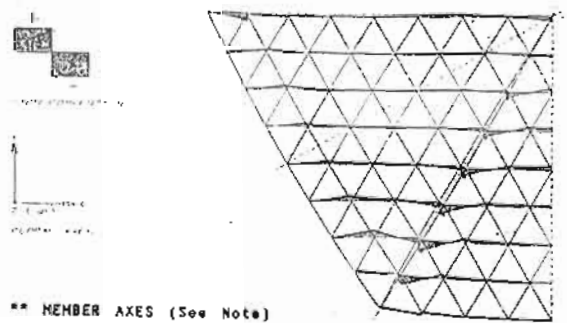

** MEMBER AXES (See Note)
SCALE: 5.0 mm: 1.0 KN.m Moment
MOMENTS: Member end Moments about Member y-axis
(Bending Moments)

Fig. (29)

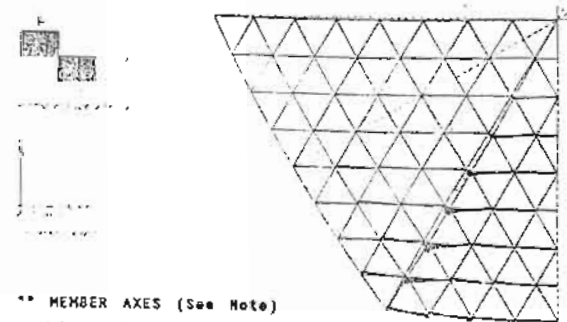

** MEMBER AXES (See Note)
SCALE: 10.0mm: 1.0 KN.m Moment
MOMENTS: Member end Moments about Member z-axis
(Bending Moments)

Fig. (30)

** MEMBER AXES:
x axis is correspondent with
member longitudinal axis.
y & z axes are correspondent with
principal axes of second moment
of area of cross section of member.
(y is maximum, z is minimum)