

9-1-1997

Forced Convective Heat Transfer through Horizontal Annular Porous Channel

Mohamed Mahgoub

Mechanical Power Engineering Department., Faculty of Engineering., El-Mansoura University., Mansoura., Egypt.

Mohamed Wasel

Mechanical Power Engineering Department., Faculty of Engineering., El-Mansoura University., Mansoura., Egypt.

H. Sarhan

Mechanical Power Engineering Department., Faculty of Engineering., El-Mansoura University., Mansoura., Egypt.

Follow this and additional works at: <https://mej.researchcommons.org/home>

Recommended Citation

Mahgoub, Mohamed; Wasel, Mohamed; and Sarhan, H. (1997) "Forced Convective Heat Transfer through Horizontal Annular Porous Channel," *Mansoura Engineering Journal*: Vol. 22 : Iss. 3 , Article 9.
Available at: <https://doi.org/10.21608/bfemu.2021.159575>

This Original Study is brought to you for free and open access by Mansoura Engineering Journal. It has been accepted for inclusion in Mansoura Engineering Journal by an authorized editor of Mansoura Engineering Journal. For more information, please contact mej@mans.edu.eg.

بِسْمِ اللَّهِ الرَّحْمَنِ الرَّحِيمِ

Forced Convective Heat Transfer Through Horizontal Annular Porous Channel*

المريان ذو العمل الجبرى خلال أنبوبة أنبوبة مسامية ذات مقطع حلقى

M. Mahgoub, M. G. Wasef, H. Sarhan
Mechanical Power Engineering Department,
Faculty of Engineering, Mansoura University,
Mansoura, Egypt

خلاصة: في هذا البحث تم عمل دراسة نظرية ومعملية للحمل الجبرى للحرارة في وسط مسامي يملأ أنبوبة أنبوبة ذات مقطع حلقى. في الجزء المعملية من هذا البحث، تم استخدام أنبوبة ذات نسبة بسدية 1.85 مصممة بحيث يمكن دراسة جميع العوامل المؤثرة على سلوك السريان. كانت كمية الفوض الحراري تتراوح بين 12.6 و 16.9 كيلو وات/متر مربع. كان الوسط المسامي المختبر يتكون من كرات مصنوعة من سبب غير قابل للصدأ ذات قطار 3 مم وكذلك 5 مم. كان معدل سريان الماء يأخذ القيم 40، 50، 60، 70 كجم/ساعة. استخدمت النتائج المعملية المتحصل عليها في حساب كل من معامل التبادل الحراري المعملية والوسط بالإضافة إلى رقم نوسلت.

في الجزء النظري من هذا البحث، تم تحويل المعادلات الواسعة للسريان إلى مجموعة من المعادلات الخطية الجبرية وذلك باستخدام طريقة اللروق المحدودة. تم تصميم برنامج للحاسب الآلي لحل هذا النموذج الرياضى الواسع للسريان. بعمل مقارنة بين النتائج المعملية والنظرية وجد تطابق مرضي بينهما. كما أنه يمكن القول - بصفة عامة - أن معامل التبادل الحراري يتزايد في الوسط المسامي على في الأاييب الفارغة.

Abstract: In present work, the forced convective heat transfer through horizontal annular porous channel is theoretically and experimentally studied. In the experimental work, annular channel with aspect ratio of 1.85 is designed such that one can study the effect of various parameters controlling the behaviour of the flow. Heat flux of 12.6 kW/m² to 16.9 kW/m² is applied to examine the effect of heat flux on heat transfer process. Porous media of diameters 3 mm and 5 mm stainless steel spherical beads are used to examine the effect of porosity on flow. Water, as a test-liquid, is used with mass flow rates of 40,50,60 and 70 kg/hr. Using the obtained experimental data, the value of local and average heat transfer coefficients and Nusselt number are calculated. In the theoretical work, the governing equations describing the problem are approximated to a set of linear algebraic equations using finite divided difference technique. Computer programs are designed to solve this mathematical model. The agreement between experimental and theoretical results is fairly good in all examined conditions, especially, in case of 5 mm bead diameter medium. The results show that, higher value of heat transfer coefficient can be obtained using porous medium compared with empty channels.

1. Introduction

The study of convective heat transfer in porous medium has, recently, a great interest seeking for better understanding of the practical associated applications such as geothermal systems, thermal insulation, grain and coal storage, solid matrix heat exchangers, oil extraction and chemical industries. Many earlier studies of heat and fluid flow in porous medium made

* Accepted in September 22, 1997.

use of the Darcy flow model [1,2]. One of the first theoretical study, taking in account boundary and inertia effects in forced convective flow through porous medium, was carried out by Vafai and Tien [3]. Vafai et al. [4] investigated, experimentally, the effects of solid impermeable boundary and variable porosity on forced convection in porous media. Effect of radial thermal dispersion on fully developed forced convection in cylindrical packed tubes was studied in [5]. Vortmeyer and schuster [6] studied the steady flow in rectangular and circular packed beds by variational methods. Theoretical and experimental studies of forced convection in an isothermal channel taking in consideration the effect of inertia, variable porosity and Brinkman friction were studied by Poulikakos and Renken [7]. Tsotsas and Schlunder [8] analysed the heat transfer in packed tubes making some remarks on the meaning and calculations of heat transfer coefficient at the wall. A theoretical analysis is performed by Cheng and Hsu [9] for fully developed forced convective flow through a packed-sphere bed between concentric cylinders maintained at different temperatures. Method of matched asymptotic expansion is used to obtain the velocity distribution. The mixing length theory, proposed by Cheng [10] for the transverse thermal dispersion, was employed to obtain the radial temperature distribution and Nusselt number for the flow in an annular bed. Recently, Chou et al. [11] performed numerical and experimental investigations of non-darcian forced convection in horizontal packed-sphere channels with constant wall-heat flux. A finite difference method, with variable grid size, was employed to solve both momentum and energy equations.

In the present work, experimental and theoretical models are designed to study the developing convective heat transfer through horizontal annular channel filled with porous medium. Constant wall-heat flux at the inner surface and thermally insulated outer surface are considered in the present proposed model.

2. Experimental Work

The experimental test loop is shown in figure (1). Water enters the test section from feed water tank (1) and leaves it to drain in an open loop circuit. Mass flow rate is measured using orifice plate (2). The tested annular passage is formed using two concentric copper tubes (5 & 6). The inner surface of the tested channel is heated, electrically, by the heater (4) of maximum power of 2 kW. The outer surface of the annular channel is insulated by a layer of glass wool. Temperature distribution along both inner and outer walls of the test section is measured by thermocouples. Electric heater is of 6 mm diameter and 800 mm effective length.

Figure (2) shows details of the test section. The annular passage is constructed using two concentric tubes. Inner and outer diameters of the inner tube are of 24 and 27 mm; respectively. The outer tube has 50 mm and 54 mm inner and outer diameters; respectively. The effective length of the test section is 800 mm long. The outer surface of the annular channel is thermally insulated by using a layer of glass wool of 50 mm thickness. Two packed porous media are tested. First one consists of 3 mm stainless steel beads and the other consists of 5 mm beads. Sufficient number of balls is used to fill, perfectly, the entire space of the annulus in random organisation.

One uses the obtained measured values of heat flux and temperature along inner and outer walls of the channel to calculate both local heat transfer coefficient and local Nusselt

number according to the following procedure. Local heat transfer coefficient and Nusselt number based on bead diameter are defined as;

$$h_d = q_s / (T_s - T_{av}) ; Nu_d = q_s d / [k (T_s - T_{av})] , \quad (1)$$

where q_s , T_s and T_{av} are the heat flux, the local temperature of inner heated surface of the tube and the average temperature of water within the tube, respectively. In the foregoing equation, bead diameter of medium is denoted as d . k is the effective thermal conductivity of porous medium. Local Nusselt number based on hydraulic diameter is evaluated to make the comparison between the case of porous medium-filled channel and empty one possible. Nusselt number in this situation is defined according to the following equation as;

$$Nu_D = q_s D / [k_f (T_s - T_{av})] , \quad (2)$$

where k_f , D are the thermal conductivity of the fluid and the hydraulic diameter of the channel; respectively.

3. Mathematical Model

The hydrodynamic flow field and thermal flow field are described through momentum and energy equations in cylindrical form. The used co-ordinate system is shown in figure (3). These governing equations are written as follows;

$$-\frac{1}{\rho} \frac{dp}{dx} + \frac{\nu}{r} \left(r \frac{d^2 u}{dr^2} + \frac{du}{dr} \right) - \frac{\nu}{K} u - A u^2 = 0 , \quad (3)$$

$$u \frac{\partial T}{\partial x} = \alpha \frac{1}{r} \frac{\partial}{\partial r} \left(r \frac{\partial T}{\partial r} \right) \quad (4)$$

Equations (3-4) must satisfy the following boundary conditions;

$$\begin{aligned} u = 0 \quad \& \quad \frac{\partial T}{\partial r} = -\frac{q_s}{k} \quad \text{at} \quad r = r_i \\ u = 0 \quad \& \quad \frac{\partial T}{\partial r} = 0 \quad \text{at} \quad r = r_o \end{aligned} \quad (5)$$

The permeability K and the parameter A appearing in momentum equation (3) are defined as the following;

$$K = \frac{d^2 \phi^3}{175 (1 - \phi)^2} \quad ; \quad A = \frac{175 (1 - \phi)}{d \phi^3} \quad , \quad (6)$$

where ϕ is the porosity and is defined according to the following equations as;

$$\phi = \phi_0 [1 + \beta_1 e^{-\beta_2 (r-r_1)/d}] \quad \text{at} \quad r_1 \leq r \leq \frac{r_1 + r_0}{2} \quad , \quad (7-a)$$

$$\phi = \phi_0 [1 + \beta_1 e^{-\beta_2 (r_0-r)/d}] \quad \text{at} \quad \frac{r_1 + r_0}{2} \leq r \leq r_0 \quad . \quad (7-b)$$

As it is shown in equations (7) and according to the investigations [6,7,9], the variation of the porosity ϕ can be approximated by an exponential function of position relative to passage walls. As it is clear, the variation of porosity in the flow direction (longitudinal direction) is neglected. The values of the coefficients ϕ_0 , β_1 and β_2 are listed in the literature for bead size of 3 mm. and 5 mm. as;

$$\text{for } d = 3 \text{ mm.} \quad \phi_0 = 0.37 \quad ; \quad \beta_1 = 0.35 \quad ; \quad \beta_2 = 3.0 \quad ,$$

$$\text{for } d = 5 \text{ mm.} \quad \phi_0 = 0.37 \quad ; \quad \beta_1 = 0.43 \quad ; \quad \beta_2 = 2.0 \quad .$$

In the momentum equation (eqn.3) the buoyancy term is neglected, since the forced convective flow is considered in this study. In energy equation (eqn.4), the fluid and porous medium are assumed to be in thermal equilibrium. The effective thermal diffusivity α is taken constant through out this analysis. Solving the governing equations (3-5), one can obtain the velocity profile and local temperature distribution at every cross-section along the passage. Consequently, local Nusselt number based on the bead diameter (Nu_d) can be evaluated according to the relation;

$$Nu_d = q_s d / [k (T_s - T_b)] \quad , \quad (8)$$

where T_b is the local bulk temperature. To put the foregoing governing equations (3-5) in dimensionless form, one introduces the following definitions of the dimensionless dependent and independent variables of the problem as;

$$r^* = r/R \quad ; \quad x^* = x/R \quad ; \quad u^* = u/U \quad ; \quad \theta = (T - T_w) / T_r \quad ,$$

where R , U and T_r are the characteristic radius, velocity and temperature; respectively. They are defined according to the following relations;

$$R = r_0 - r_1 \quad ; \quad U = \alpha / (r_0 - r_1) \quad ; \quad T_r = q_s R / k \quad .$$

Substitution in the governing equations and their boundary conditions (3-5) yields to the dimensionless form of these governing equations and their boundary conditions as;

$$B + \frac{d^2 u^*}{d r^{*2}} + \frac{1}{r^*} \frac{d u^*}{d r^*} + S_1 u^* + S_2 u^{*2} = 0 \quad , \quad (9)$$

$$u^* \frac{\partial \theta}{\partial x^*} = \frac{1}{r^*} \frac{\partial \theta}{\partial r^*} + \frac{\partial^2 \theta}{\partial r^{*2}} \quad , \quad (10)$$

$$u^* = 0 \quad \& \quad \frac{\partial \theta}{\partial x^*} = -1 \quad \text{at} \quad r^* = r_1^* \quad , \quad (11)$$

$$u^* = 0 \quad \& \quad \frac{\partial \theta}{\partial r^*} = 0 \quad \text{at} \quad r^* = r_0^* \quad ,$$

where S_1 , S_2 and B are coefficients defined as follows;

$$S_1 = -R^2 / k \quad ; \quad S_2 = -U R^2 A / \nu \quad ; \quad B = -\frac{R^2}{U \nu} \frac{1}{\rho} \frac{dp}{dx^*} \quad .$$

Similarly, one can express Nusselt number Nu_d (eqn. 8) in dimensionless form as;

$$Nu_d = -\frac{d}{R} (\theta_s - \theta_b) \quad , \quad (12)$$

where θ_s and θ_b are dimensionless surface and bulk temperatures, respectively. The average Nusselt number along the tube of length L , is calculated according to the following relation as;

$$\overline{Nu_d} = \frac{1}{L} \int_0^L Nu_d dx^* \quad . \quad (13)$$

Dimensionless form of momentum and energy equations (9-10) are individually solved, numerically, using finite divided difference technique. According to this technique, both equations transformed to set of linear algebraic equations. Since the coefficient matrix of both sets is of tridiagonal-matrix type, it is suitable to solve them using Tomas tridiagonal matrix algorithm [15]. Because of the severe variations of velocity and temperature near the channel walls as shown in figure (3), the used step size in direction normal to the wall is taken variable such that, it is smaller near the walls [7,12]. Energy equation (10) is solved in both directions; normal and along the axis of the channel. The step size along the axis has a suitable single value. The numerical solution of this energy equation is carried out in step by step

manner. Accordingly, the solution is carried out at certain value of x^* and then at the next position $(x^* + \Delta x^*)$ and so on.

4. Experimental And Theoretical Results

The experiments are carried out for heat flux of 12.6, 14.1, 15.6 and 17.1 kW/m². In these experiments, water is circulated at rates of 40, 50, 60 and 70 kg/hr. Two porous media consist of packed spheres of diameter 3 mm and 5 mm are examined. To check the validity of mathematical model, a comparison is made between the obtained results of experimental and theoretical analysis. To study the effect of using porous media on the heat transfer process, empty channel is tested and a comparison is made between the obtained results in both cases of filled and empty channels.

Figure (4) shows the behaviour of local Nusselt number against the dimensionless position along the channel axis (x/L). The value of Nusselt number is, in general, gradually decreased for all values of heat flux. Also, the value of Nusselt number increases as the applied heat flux increases. Figure (5) shows Nusselt number along the channel in case of 5 mm bead diameter medium. Nusselt number is, generally, higher in case of 5 mm bead diameter compared with that of 3 mm bead diameter [Fig. (4)].

To examine the validity of the theoretical model, a comparison is made between the experimental results and those evaluated using the mathematical model. Figures (6-7) show the surface temperature along the channel in case of 3 and 5 mm bead diameter and at different values of mass flow rates (different values of Reynolds number). According to these figures, good agreement between experimental and theoretical results is noted, especially for case of smaller flow rates (smaller values of Reynolds number). In general, the deviation between the experimental and theoretical results is greater near the ends of test section. This deviation, near the ends of the tube, may be due to the negligence of variation of fluid-porous matrix properties with temperature. Moreover, the effect of longitudinal heat dispersion is neglected in the theoretical model. Figures (8-9) depict local and average Nusselt number in case of 5 mm bead diameter. As shown in figure (8), the theoretically obtained results have higher values, especially, near the ends of the tube while the experimentally obtained results are higher in the interior part of the tested tube. Figure (9) shows average Nusselt number versus Reynolds number. As it is clear, average Nusselt number increases with increasing Reynolds number. Also, one can see that, theoretically obtained Nusselt number is almost linearly increased with Reynolds number. Both theoretical and experimental results show good agreement between each other, especially, at moderate values of Reynolds number.

The enhancement of heat transfer process associated with using porous medium is shown in figure (10). A comparison between porous medium-packed channel and empty channel is presented. As it is clear, the use of packed channel improves the heat transfer process whatever the bead diameter is. Increasing the bead diameter yields higher values of Nusselt number. Figure (11) shows the increase of pumping power due to the use of porous medium in heat transfer process. As it is clear, the pressure drop across the channel length increases as the bead diameter decreases, especially, for higher values of flow rates. According to figures (10-11), a compromise must be done to determine the optimum condition of using porous medium-packed bed in heat transfer processes.

The following figures (12-14) show samples of results that may be evaluated using the theoretical model. Figure(12) shows the effect of bead diameter on the dimensionless velocity profile across the pipe. As it is shown, the velocity overshoot increases as the bead diameter increases. The velocity overshoot near the tube walls is, previously, reported in the study of Vortmeyer and Schuster [6] in case of flow in circular ducts. Figure (13) shows the effect of dimensionless pressure drop (corresponding to $B=10^4, 5 \times 10^4 \& 10^5$) on the velocity profile. As it is expected, increasing the value of B yields to higher values of local velocity and consequently higher values of average velocity as well as mass flow. Figure (14) illustrates the dimensionless temperature θ in radial direction at different position along the tube length. It is shown that, the temperature decreases gradually from the inner surface to the outer surface of the channel. Moving down stream (higher values of x/L) yields higher values of temperature due to the continuous heat addition.

5. Conclusions

In the present work, a theoretical model is proposed to analyse forced convective flow through an annular passage filled with porous medium. With aid of this model, thermal and hydrodynamic flow field can be predicted through out the passage. Accordingly, local and average heat transfer coefficients as well as; Nusselt number can be evaluated for different flow parameters. According to experimental and theoretical results, the use of porous medium enhances the heat transfer processes.

Nomenclature

- D Hydraulic diameter, m
- d Bead diameter, m
- h Local heat transfer coefficient, W/m^2
- K Permeability, eqn (6), m^2
- k Effective thermal conductivity, $W/m \text{ } ^\circ C$
- L Test section length, m
- Nu_D Nusselt number based on the hydraulic diameter of the tube, eqn. (1)
- Nu_d Nusselt number based on the bead diameter, eqn. (2)
- p Pressure, N/m^2
- q Heat flux, W/m^2
- r Radial co-ordinate, m
- r_i Inner radius of tested tube, m
- r_o Outer radius of tested tube, m
- T Temperature, $^\circ C$
- u Average velocity, m/s
- U Characteristic velocity, $U = \alpha / (r_o - r_i)$
- x Axial coordinate, m

Greek symbols

- α Effective thermal diffusivity, m^2/s

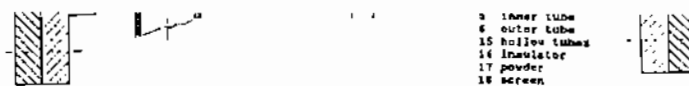
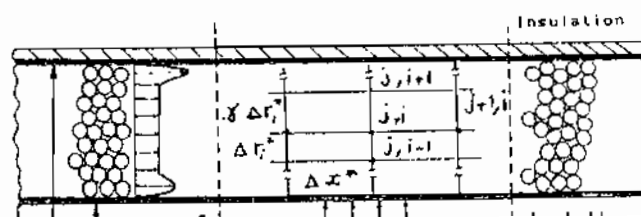

Fig. (2) Details of the test section.



ϕ	Porosity, eqns. (7)
ν	Kinematic viscosity, m^2/s
θ	Dimensionless temperature
ρ	Density, kg/m^3

References

1. A. Bejan, "Convection heat transfer", John Wiley Int., 1984.
2. R. A. Greenkorn, "Principles of flow through porous media", Unit Operations of Slurry Flows, Vol. 1, 1970.
3. K. Vafai and C. L. Tien, "Boundary and inertia effects on flow and heat transfer in porous media", Int. J. Heat Mass Transfer, Vol. 24, pp. 195-203, 1981.
4. K. Vafai, R. L. Alkire and C. L. Tien, "An experimental investigation of heat transfer in variable porosity media", J. Heat Transfer, Vol. 107, PP. 642-647, 1985.

ϕ	Porosity, eqns. (7)
ν	Kinematic viscosity, m^2/s
θ	Dimensionless temperature
ρ	Density, kg/m^3

References

1. A. Bejan, "Convection heat transfer", John Wiley Int., 1984.
2. R. A. Greenkorn, "Principles of flow through porous media", Unit Operations of Slurry Flows, Vol. 1, 1970.
3. K. Vafai and C. L. Tien, "Boundary and inertia effects on flow and heat transfer in porous media", Int. J. Heat Mass Transfer, Vol. 24, pp. 195-203, 1981.
4. K. Vafai, R. L. Alkire and C. L. Tien, "An experimental investigation of heat transfer in variable porosity media", J. Heat Transfer, Vol. 107, PP. 642-647, 1985.
5. E. Tsotsas and E. U. Schlunder, "Some remarks on channelling and radial dispersion in packed beds", Chem. Eng. Sci., Vol. 43, pp. 1200-1203, 1988.
6. D. Vortmeyer and J. Schuster, "Evaluation of steady flow profiles in rectangular and circular Packed-beds by variational method", Chem. Eng. Sci., Vol. 38, 1983.
7. D. Poulidakos and K. Renken, "Forced convection in a channel filled with porous medium including the effects of flow inertia", J. Heat Transfer, Vol. 109, PP. 880-888, 1987.
8. E. Tsotsas and E. U. Schlunder, "Heat transfer in packed-beds with fluid flow: Remarks on the meaning and the calculation of a heat transfer coefficient at the wall", Chem. Eng. Sci., Vol. 45, PP. 819-837, 1990.
9. P. Cheng and C. T. Hsu, "Fully developed forced convective flow through an annular packed-sphere bed with wall effects", Int. J. Heat Mass Transfer, Vol. 29, PP. 1843-1853, 1986.
10. P. Cheng and D. Vortmeyer, "Transverse thermal dispersion and wall channeling in a packed-bed with forced convective flow", Chem. Eng. Sci., Vol. 43, PP. 2523-2532, 1988.
11. F. C. Chou, W. Y. Lien and S. H. Lin, "Analysis and experiment of non-darcian convection in horizontal square packed-sphere channels - 1. Forced convection", Int. J. Heat Mass Transfer, Vol. 35, PP. 195-205, 1992.
12. K. Renken and D. Poulidakos, "Experiment and analysis of forced convective heat transport in packed-bed of spheres", Int. J. Heat Mass Transfer, Vol. 31, PP. 1399-1408, 1988.
13. T. D. McGee, "Principles and methods of temperature measurements", John Wiley and Sons New York, 1986.
14. T. Cebeci and P. Bradshaw, "Physical and computational aspects of convection heat transfer", Springer-Verlag, New York, 1984.
15. C. F. Gerald and P. O. Wheatley, "Applied numerical analysis", Addison-Wesley, Inc., 1978.

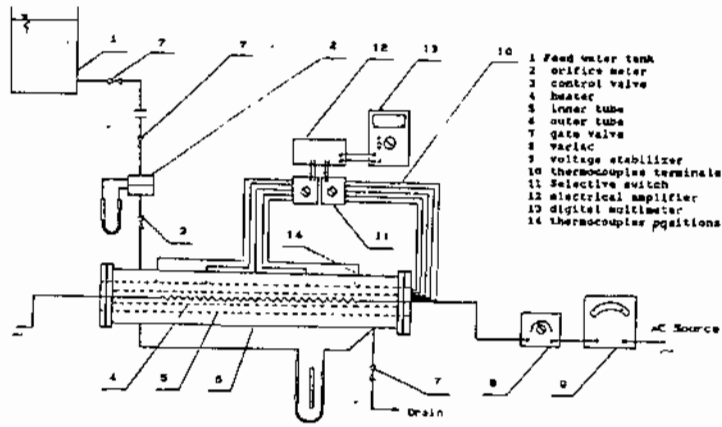

Fig.(1) Schematic layout of the experimental test loop.

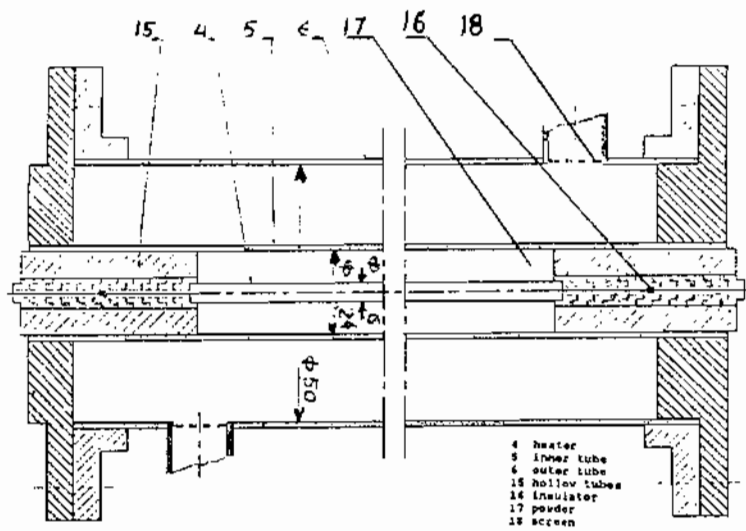

Fig.(2) Details of the test section.

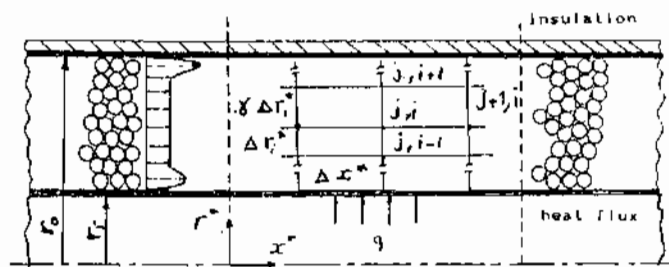

Fig.(3) Coordinate system for the numerical solution.

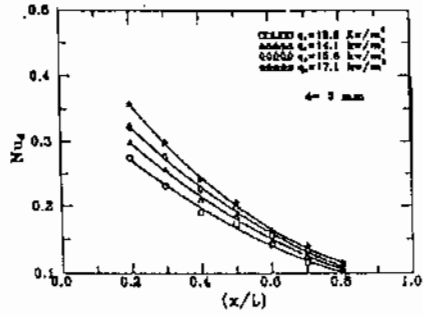

Fig.(4) Effect of heat flux change on local Nusselt number for flow rate of 40 kg/hr , $d=3$ mm.

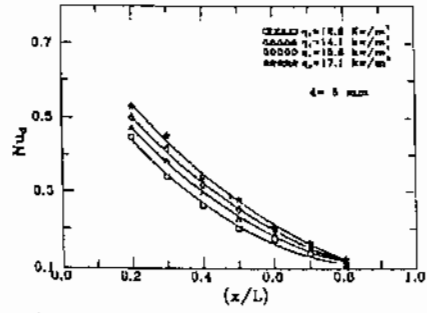

Fig.(5) Effect of heat flux change on local Nusselt number for flow rate of 40 kg/hr , $d=5$ mm.

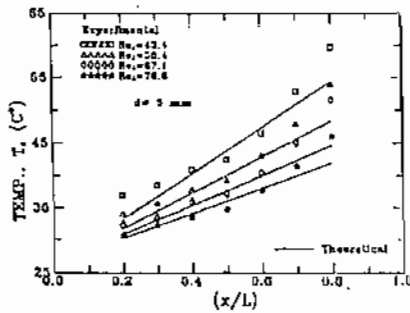

Fig.(6) Comparison between theoretical and experimental surface temperature for heat flux of 12.6 kW/m^2 , $d=3$ mm.

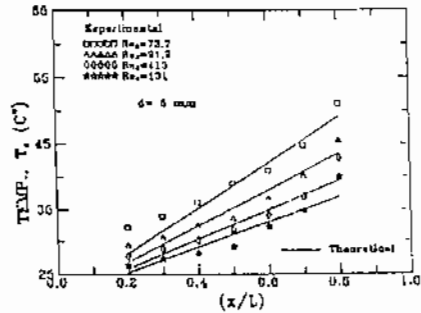

Fig.(7) Comparison between theoretical and experimental surface temperature for heat flux of 12.6 kW/m^2 , $d=5$ mm.

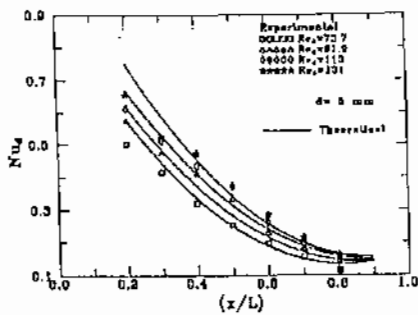

Fig.(8) Comparison between theoretical and experimental ball diameter based Nusselt number for heat flux of 15.6 kW/m^2 .

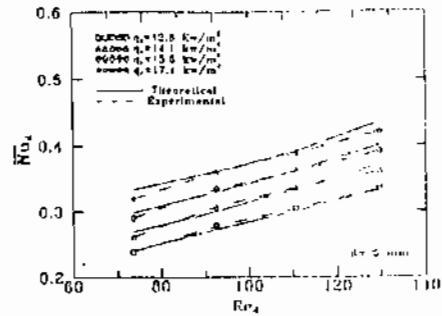

Fig.(9) Comparison between theoretical and experimental average Nusselt number versus Reynolds Number.

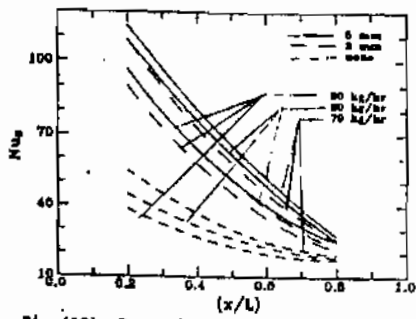

Fig. (10) Comparison between packed channel with different bead diameter and empty channel for heat flux of 17.1 kw/m^2 .

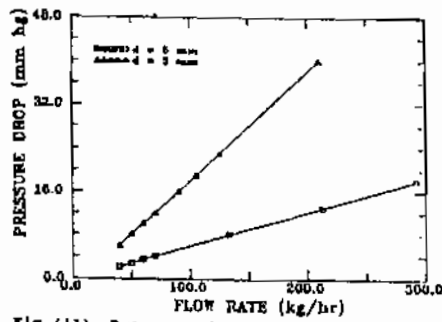

Fig. (11) Pressure drop across the channel using porous media of different bead diameters.

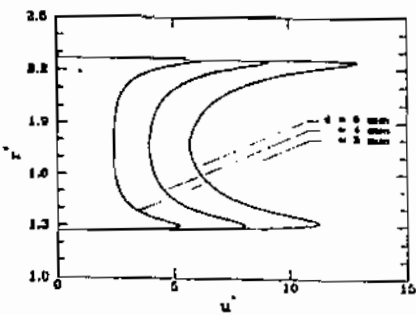

Fig. (12) Dependence of velocity distribution on bead diameter of packed bed for $B=5 \cdot 10^2$.

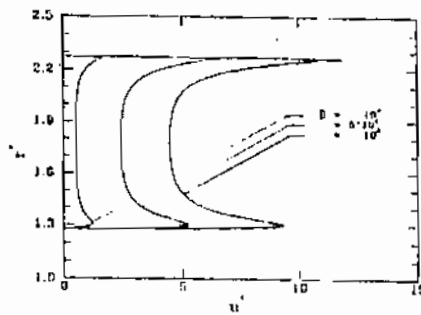

Fig. (13) Dependence of velocity distribution on parameter B for $d=3 \text{ mm}$.

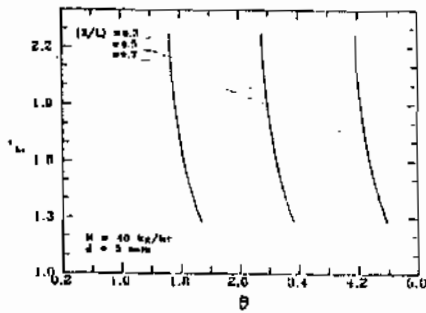

Fig. (14) Radial temperature distribution at different values of (x/L) for $d=5 \text{ mm}$.