

12-1-2020

Active Vibration Suppression in a Flexible Cantilever Beam Using Fuzzy Logic Controllers.

A. Al-Dmour

Electrical Engineering Department., Engineering College., Mu'tah University Mu'tah., Karak Jordan.

Follow this and additional works at: <https://mej.researchcommons.org/home>

Recommended Citation

Al-Dmour, A. (2020) "Active Vibration Suppression in a Flexible Cantilever Beam Using Fuzzy Logic Controllers.," *Mansoura Engineering Journal*: Vol. 23 : Iss. 4 , Article 2.

Available at: <https://doi.org/10.21608/bfemu.2021.150014>

This Original Study is brought to you for free and open access by Mansoura Engineering Journal. It has been accepted for inclusion in Mansoura Engineering Journal by an authorized editor of Mansoura Engineering Journal. For more information, please contact mej@mans.edu.eg.

Active vibration suppression in a flexible cantilever beam using fuzzy logic controllers

التحكم باهتزازات أنظمة الهياكل المرنة باستخدام نظام المنطق المشوش

A S Al-Dmour
Electrical Engineering Department
Engineering College
Mu'tah University
Mu'tah-Karak
Jordan

ملخص: يقدم هذا البحث حلاً مناسباً لمشاكل الاهتزازات في أنظمة الهياكل المرنة المشوشة من أحد أطرافها وحررة من الطرف الآخر باستخدام طريقة تحكم متبادلة أنتج هذا الحل باستخدام نظام تحكم مسمى على المنطق المشوش المتعدد. الواحد أو أكثر من المحركات التحكمية. يستخدم نظام التحكم هذا الفسوق والتعريف في الفرق ما بين رد الفعل للنظام المتعدد وآخر يستخدم كمرجع من أجل الحصول على رد الفعل المرغوب له النظام الديناميكي المراد التحكم به. لقد ضمن نظام التحكم على محاكي النظام المراد التحكم به وأظهرت النتائج قدرته العالي على القضاء الاهتزازات المراد دونه.

Abstract: This paper presents a novel control system to find a suitable solution for addressing the vibration problem in fixed-free cantilever beam system structures. The solution is generated using a fuzzy logic controller (FLC) utilizing single and multiple control actuators. The fuzzy controller employs the error (between a reference model output and the cantilever response) and error change to generate the control input increment in order to preserve the desired reference model performance. The controller is tested within a simulation environment. Results show that an excellent control performance is possible.

Keywords: Flexible structures, cantilever beam, active control, fuzzy controller

1. Introduction

The area of vibration control is enormous, covering a wide area ranging from civil engineering applications, such as buildings and suspension bridges, to various problems in aerospace structures such as wing flutter in aircraft and the swaying of satellite solar panels. Consequently, this has received considerable attentions by scientists and researchers in specific aspects such as, modeling and simulation (Alghannam, 1995), damping and control (passive and active as well as hybrid) (Balas, 1979 and 1978). (3), (4)

The active control of vibration problems in flexible beam structures has been an important topic of research in recent years. The analysis and design of controllers for such structures have mainly been used on complicated models. To reduce this complexity, several approximations to the mathematical models can be made. However, in practice, it is quite difficult to construct a model which characterizes the system completely and accurately, yet compact enough for easy implementation. These problems could be solved with incorporating the more recent heuristic ideas of intelligent control to actively suppress oscillations in flexible structures. These include neural networks (NNs), genetic algorithms (GAs) and fuzzy logic controllers (FLCs). The NNs and GAs have been investigated where good results have been achieved (Al-Dmour, 1996) however, in this paper fuzzy control techniques are utilized so that their potentials in the considered application can be assessed. Fuzzy logic is worth studying since, at a commercial level, it has been used with great success to control a wide range of machines and consumer products whereas, at a functional level, it has been demonstrated that there are a wide range of appropriate applications because fuzzy logic are simple to design and implement. Moreover, fuzzy logic works well and it is based on simple, and easily understood principles (2)

The application of fuzzy logic for control systems has been the subject of considerable research in recent years; some important contributions on this subject include (Ghazli, 1996; Wang, 1993; Al-assaf et al., 1995; Higgins et al., 1994; Kung et al., 1994). The main feature of a fuzzy controller is that it is easy to apply heuristic knowledge without involving a tedious mathematical analysis. Also this controller may convert linguistic rules usually based on expert knowledge (Zadeh, 1975) into automatic control strategy. So it can be applied to control dynamic systems with known or unknown models. (6) (13) and (14)

In this paper, the use of the FLC for vibration suppression of a flexible cantilever beam using a single control actuators is considered first; the flexible cantilever beam structure is considered as a core case study, since it provides the basis for many flexible structures applications. Actually when utilizing only one control actuator to achieve global minimization of the vibration along the beam, satisfactory performance may not be possible to suppress the cantilever beam's vibrations to the required level. Therefore, it is the intention of this work to investigate the vibration suppression performances using multiple control actuators so that there is flexibility in placement and control design to achieve the desired results. Furthermore, multiple control actuators allow us the design of fault tolerance solutions by which the controller reconfigures itself under actuator failures. This method also utilizes the functional actuators to maintain the performance of the vibration suppression system to be as close as possible to the level of the non-failed condition.

Before discussing the design of FLCs and how they can be applied to suppress the vibration of a cantilever beam system, a brief introduction to the lateral vibration of a cantilever beam structure is presented.

2. Lateral vibration of a flexible cantilever beam structure

The time response of a beam in lateral motion is described by the following fourth order partial differential equation (PDE) (Meirovitch, 1986; Tse et al., 1978): (10) (11)

$$EI \frac{\partial^4 y(\alpha, t)}{\partial \alpha^4} + m \frac{\partial^2 y(\alpha, t)}{\partial t^2} = f_d(\alpha, t) + f_c(\alpha, t) \quad (1)$$

where α is the distance along the beam from the fixed end, $y(\alpha, t)$ is the displacement of the beam at point α and at time t , $f_d(\alpha, t)$ and $f_c(\alpha, t)$ are the disturbing and controlling signals acting on the beam at point α and time t respectively, m is the beam mass per unit length and EI is the flexural rigidity of the beam. It is well known that the resonance frequencies for the fixed-free beam are given by (Tse et al. 1978):

$$\cos(\beta_i l) \cosh(\beta_i l) = -1 \quad \text{for } i=1, 2, \dots, n \quad (2)$$

where l is the beam length, β_i are the roots of the characteristic equations, n is the number of the

considered modes. $\beta_i^4 = \frac{\omega_i^2}{\mu^2}$, ω_i is the i th mode natural frequency and $\mu^2 = \frac{EI}{m}$. According to the

cantilever system data (presented in Appendix A), it is straightforward to calculate our beam's resonance frequencies; the first five natural frequencies are 1.14, 7.12, 19.93, 39.05 and 64.56 Hz (Al-Dmour, 1996). (2)

To construct a suitable simulation platform to test and verify the control mechanisms, a method for obtaining the numerical solution of the PDE in Eq. (1) is required. Several such methods are available; one of the most popular approaches is based on approximating the derivatives by their difference approximations. This leads to various finite difference (FD) simulation methods such as forward, backward and central FD methods (Kourmoulis, 1990). The central FD is the most accurate method, and therefore deployed here for simulation purposes (Alghannam, 1996). The FD method is simple to implement and gives good and accurate approximations to the dynamic behavior of the cantilever beam system (Virk et al., 1995).

3. Active vibration suppression system structure

Generally the schematic diagram of the arrangement of an active vibration control system is as shown in Fig. 1 where a disturbance force is applied at a distance x from the clamped end in order to excite the beam. The deformation of the beam is measured by sensors (observation points (OPs)) and measurements are utilized to generate the control force using some design philosophy, while the cancellation forces are implemented via control actuators (CAs) to suppress the vibrations at the control points (CPs). It is clear that, there are many configurations that may arise with possible

variations in the number of observation points, number of control actuators and the number of control points together with various possible locations for the sensors and actuators. In the main, only one sensor, one (or two) control actuator(s) are considered and that the control point is the same as the observation point. The sensors as described earlier measure beam deflections but other quantities such as velocity or acceleration could be measured by utilizing appropriate sensors.

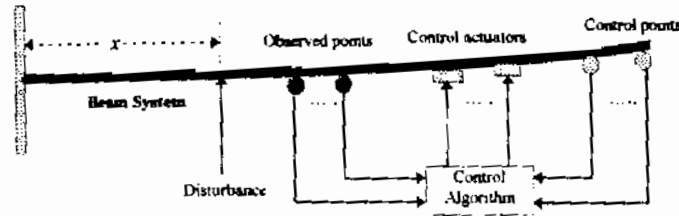

Figure 1. Schematic diagram of the active control system

4. Design of fuzzy controller with single control actuator

Fuzzy logic control is based on fuzzy set theory, which has been developed by (Zadach, 1975). The fuzzy set is a set whose membership function (characteristic function) takes values between zero and one. In the design of fuzzy controller, the required variables to be observed and controlled should be identified which are chosen here to be the deflection at certain locations along the beam. Also the input and output fuzzy linguistic variables and their membership functions need to be defined. Usually, the input variables are selected to be the error (e) (the error is the difference between a reference model output and the system output) and the change in error (Δe) and may be expressed as:

$$e(k) = y_m(k) - y_s(\alpha, k) \tag{3}$$

$$\Delta e(k) = e(k) - e(k-1) \tag{4}$$

where,

$y_m(k)$ is the model reference output at k^{th} sampling instant and $y_s(\alpha, k)$ is the beam system deflection at point α and at k^{th} sampling instant and $v(\alpha, k)$ is the beam system deflection at point α . Basically the fuzzy controller comprises three main steps, these are; fuzzification, control rule evaluation and defuzzification.

In the fuzzification process, the error and change in error are fuzzified into membership functions χ_e and $\chi_{\Delta e}$ as shown in Figs. 2 & 3 respectively. Here both e and Δe are converted into five linguistic variables: Negative Large (NL), Negative Small (NS), Zero (ZE), Positive Small (PS) and Positive Large (PL). Also the controller output increments have five membership functions as shown in Fig. 4: Large Negative (LN), Medium Negative (MN), Small (SM), Medium Positive (MP) and Large Positive (LP).

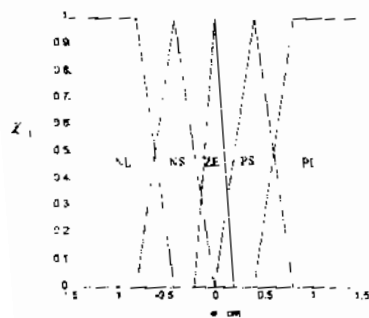

Figure 2. Fuzzy membership functions for error

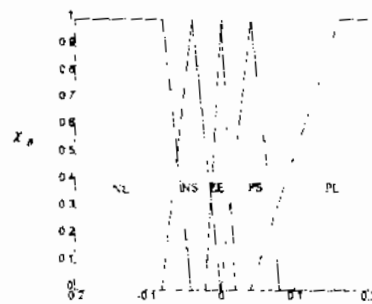

Figure 3. Fuzzy membership functions for change in error

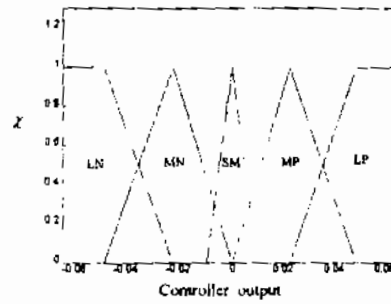

Figure 4 Fuzzy output membership functions

Actually the values of these linguistic variables are selected according to the possible range in the error signal and the maximum possible controller output changes.

Based on the membership function, and our heuristic knowledge from the results that have been obtained in (Al-Dmour, 1996); the fuzzy control rules that are used are summarized in Table 1. These rules, usually expressed in the IF-THEN form, are implied in this table, for example, for the element in the first row and the first column implies that:

IF (e is NL and Δe is NL)

Then (the increment of the control signal is LN).

Table 1: Fuzzy control rule

Action	Error (e)					
	NL	NS	ZE	PS	PL	
Change in error (Δe)	NL	LN	LN	MN	MP	MP
	NS	LN	MN	SM	MP	MP
	ZE	MN	SM	SM	SM	MP
	PS	MN	MN	SM	MP	LP
	PL	MN	MN	MP	LP	LP

It is clear from Table 1 that there are twenty five permutations of conditional rules and it is required to translate them into mathematical format for each fuzzy output membership function by using fuzzy set theory, and AND and OR operators as:

$$x_i \text{ AND } x_j = \text{Min.} \{ x_i, x_j \}$$

$$x_i \text{ OR } x_j = \text{Max.} \{ x_i, x_j \}$$

for any two membership values x_i and x_j . The resulting values (or the fuzzy control action) are the degree of the membership, x , for the fuzzy output membership functions.

The final stage of the fuzzy controller design is the defuzzification process. In this process the fuzzy control action is defuzzified using defuzzification strategy to obtain a crisp control action. The most commonly used strategy is the center of gravity (COG), since it has been found to give smooth control signals (Al-assaf et al., 1995); here each output membership above the value indicated by its respective fuzzy output is truncated. The resulting membership function are then combined and the overall COG is calculated. The calculated value represents the incremental control signal which is then used to modify the control signal of the cantilever beam.

4.1 Control simulation results

The fuzzy control strategy discussed in Section 4 was tested within a simulation environment using FD for the beam system; a 20 station (or sections) FD approximation is used because this gives reasonable accuracy as was discussed in (Virk et al., 1994).

Before presenting the control simulation results, the most dominant modes which do exist in our beam system need to be illustrated. It is assumed that the beam is disturbed by a unit step force of 0.1 N by an actuator placed at the end of the beam. In addition the observation point is assumed to be at the free end. An indication of how many modes exist can be attained by studying the power density spectrum of the beam's time response to disturbances (say, a step). Such a spectrum density plot is as shown in Fig. 5 where it can be observed that the first three modes are dominant for the beam under consideration.

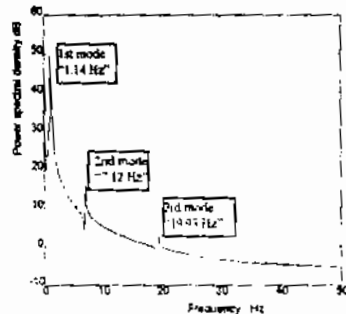

Figure 5: Dominant modes of the disturbed beam

It should be noted that the power spectral density should have units of m^2 / Hz ; in this work however these values are presented in dB units which reflect the power density as a ratio compared with unity. There is no natural damping assumed in the FD simulation and hence, the response peaks in Fig. 5 should be infinity. However, in practice the frequency spectrum is numerically calculated in discrete frequencies which inevitably miss the exact resonance resulting in the reduced peak observed.

The set of simulation results to be followed show the effectiveness of the fuzzy control strategy on the performances of the cantilever system. Simulation is carried out for a 6 sec period when a step force of 0.1 N is applied at location 0.587 from the clamped end. The disturbing force is located here because it will excite all the dominant modes. The control actuator and the observation point are both located at the free end of the beam since, this location is not or near a node (zero deflection) of the most dominant modes (see Appendix A). The time step size for the finite difference simulation was chosen to be 0.2 msec which is sufficient to cover all the dominant resonance modes of the beam. The three dimensional description of the vibration of the uncontrolled beam along its length is as shown in Figure 6 where it is clear that the beam deflection is zero at the clamped end and increases with the distance α from the fixed end, and reaching a maximum at the free end. This result is as expected and it confirms the validity of the FD simulation in representing the behavior of the cantilever beam. Figure 7 shows a 3D plot of the beam response throughout its length when the controller is turned on after 3.0 sec. Thus, it can be concluded that the fuzzy controller works well for our system where good damping is observed.

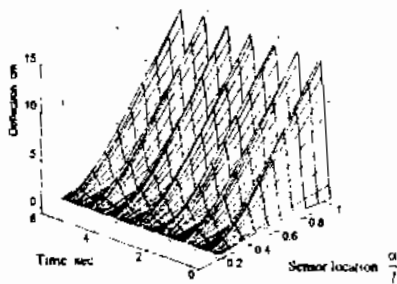

Figure 6: Cantilever beam response before cancellation

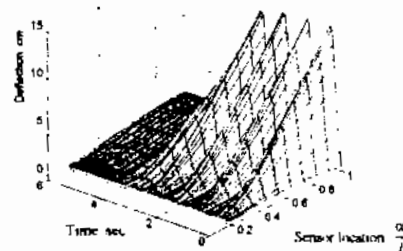

Figure 7: Comparison of system response and model output

Figure 8 shows the time responses of the reference model and the beam system measured at the free end for fixed and different values of the reference levels. The responses show that the controlled system and the reference model outputs are in a good agreement with each other. This leads to the conclusion that wide band cancellation of the vibration has been achieved. To assess the performance of the controller it is useful to obtain the power spectral densities of the beam responses before and after cancellation. This is shown in Fig. 9 which indicates that the cancellation is significant over the frequency range covering the first three modes. The attenuation is found to be 45.50 dB for mode 1, 32.50 dB for mode 2 and 22.0 dB for mode 3 giving a net average over the first three modes of 33.33 dB.

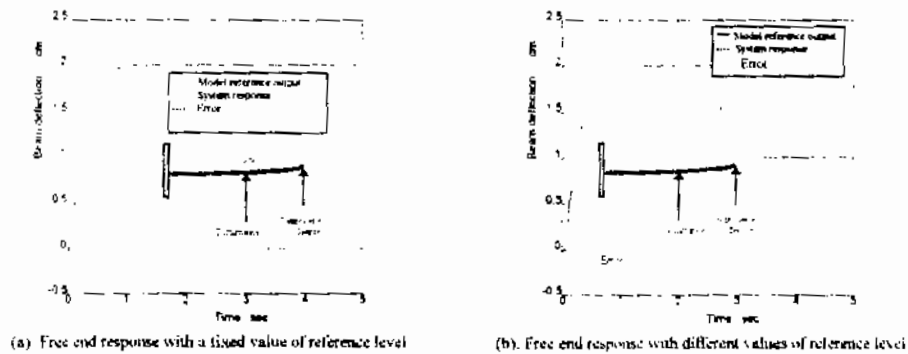

Figure 8: Free end response for a step force

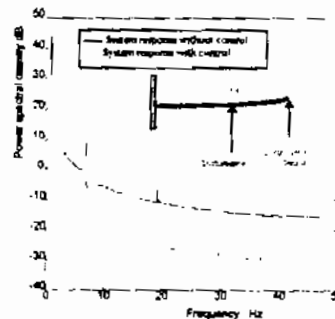

Figure 9: Power densities before and after cancellation

Such an attenuation in the level of vibration is reflected throughout the beam as shown by the time-domain and the corresponding frequency-domain (before and after cancellation) descriptions of the beam behavior in Figs 10 and 11 respectively. These results demonstrate the capability of the fuzzy controller to suppress the vibration along the flexible cantilever beam length. Consequently, it is clear that the reduction in the vibration levels at some points along the beam is not the same as that obtained in the free end since the control action is based on the deflection measured at this location. For achieving effective global minimization in the vibration level, it is necessary to investigate the performance of the multi-control actuator situation. It should be noted that the kinks in Fig. 11 at distances 0.477 and 0.797 from the clamped end indicate the location of the third and second nodal nodes respectively.

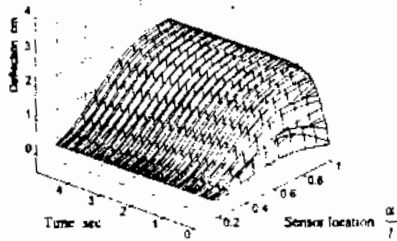

Figure 10: Beam fluctuation after cancellation

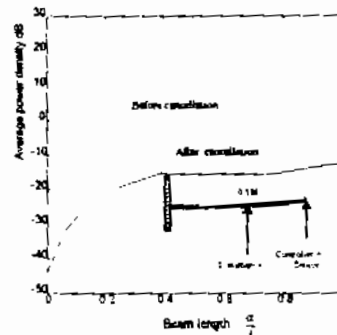

Figure 11: Average power spectral densities before and after cancellation

5. Design of fuzzy controller with multiple control actuators

The analysis presented above has demonstrated the design of a single-input control system, that is one which uses just one control actuator. In this section the analysis is extended to embrace the multi-control actuator situation for the cantilever beam. To investigate the performance of such situation, the beam system with two control sources is considered, one located at the free end and the other at a distance 0.63l from the clamped end since these locations are not at or near a node of the most dominant modes of the system. The disturbance force is assumed to be applied at 0.58l from the clamped end and there are two observation points (upon which the control action is based), one located at the free end and the other at 0.63l from the clamped end. The design of FLC will also employ the error and the error rate as for the case of single-input control design. For present case, since the system has two control actuators four inputs are required: two from the output errors e_1 and e_2 and two from the error rate Δe_1 and Δe_2 , in order to calculate the increments in the two control signals, namely, ΔC_1 and ΔC_2 . In this design, the system structure is shown in Fig. 12 where the design procedure follows the three main steps in fuzzy controller design, that is, fuzzification, rule evaluation and defuzzification.

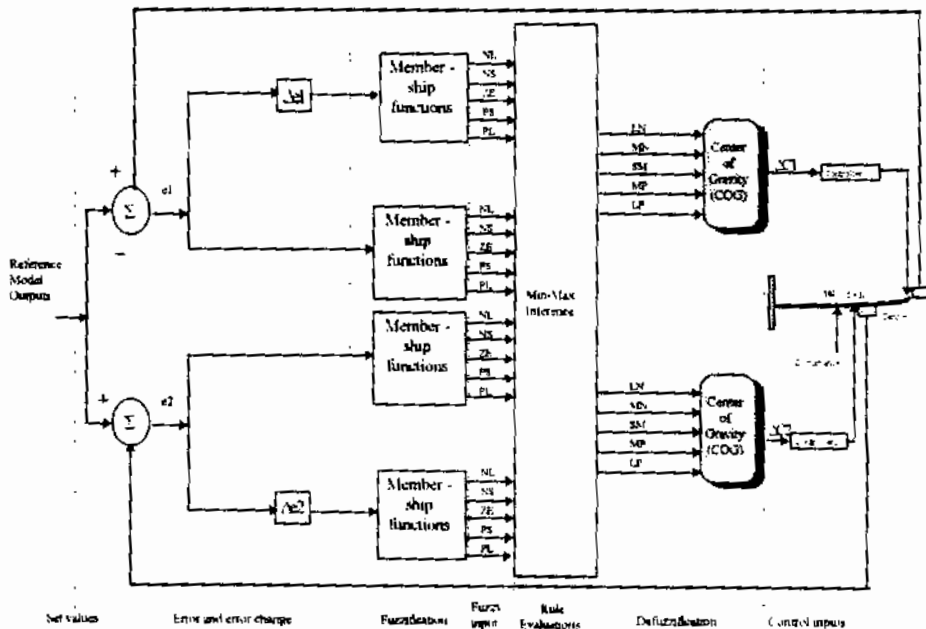

Figure 12: Block diagram of a FLC using two controllers

In the fuzzification process, the error signal, error rate and the controllers output increments are fuzzified for both controllers into five membership values as shown in Fig. 13. The constants LSS, LE, ZS, SE, LOS, LOE, SO, and ZO used in the definition of the membership functions will be fixed after being determined in the simulation results. In this design, the fuzzy rules for the two controllers are assumed to be similar to those shown in Table 1. After the control rules have been determined, the final stage of the design is the defuzzification process where the fuzzy output membership function is converted into its crisp value. Then, the FLC outputs, or equivalently, the control input increments $\Delta C1$ and $\Delta C2$ are respectively added to the pervious control inputs in order to obtain the present ones for both controllers before being fed to the cantilever system.

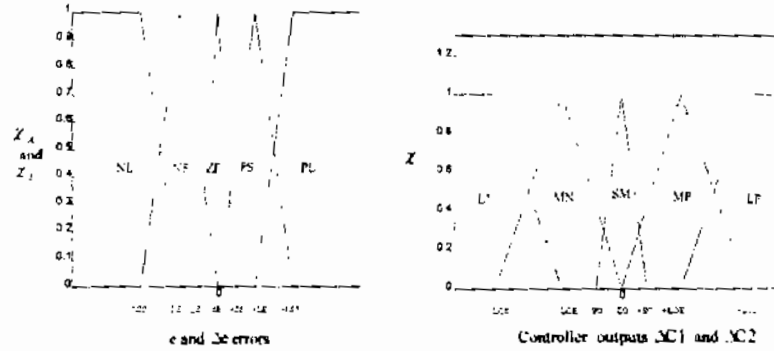

Figure 13: Fuzzy membership functions

5.1 Simulation results

In this section, some simulation results are presented using the FLC developed in Section 5. A simulation program was developed by applying the fuzzy design procedure presented above and the scaling factors in Tables 2 and 3. The fuzzy input domains as presented in Table 2 are arbitrary chosen but the fuzzy output domains in Table 3 were obtained after several simulation trials carried out in the above conditions so that the desired overall control performances can be achieved.

For the FLC based on a multi-input control design, the control performance is as shown in Figure 14. This illustrates the time-domain description along the length of the beam. Also it demonstrates better performances over that obtained using single controller. This is because more energy can be transferred from the two control actuators to the beam structure and also there is an energy transfer from one actuator to another which cause more damping in the vibrations of the beam. This is further evidenced in the corresponding frequency-domain (presented in the form of average power spectral densities) description in Fig. 15 where a clear indication about the effective global reduction in the vibration levels can be observed as compared with the reduction obtained using single input control design.

Table 2: Scaling factors of fuzzy input function

Fuzzy input scaling factor		NL and PL		NS and PS		ZE
		LSS	LE	LSS	SE	ZS
Ranges for Controller 1 (cm)	e1	2.2	0.77	2.2	0.0	0.11
	Δe1	1.25	0.44	1.25	0.0	0.062
Ranges for Controller 2 (cm)	e2	2.2	0.77	2.2	0.0	0.055
	Δe2	1.25	0.44	1.25	0.0	0.032

Table 3: Scaling factors for fuzzy output membership functions

Fuzzy controller output	NL and PL		NS and PS		ZE
	LOS	LOE	LOS	ZO	SO
$\Delta C1$ (N)	0.21	0.067	0.21	0.0	0.021
$\Delta C2$ (N)	0.22	0.075	0.22	0.0	0.015

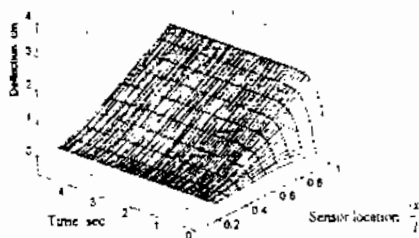

14: Beam response after cancellation

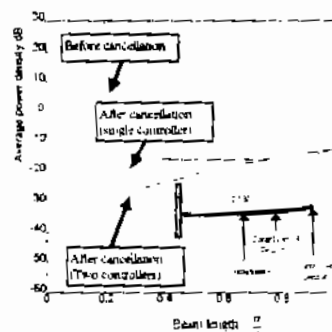

Figure 15. Average spectral density along the beam for single and two control actuators

Having successfully designed a fuzzy controller with two control actuators that can effectively cancel globally the vibration throughout the beam length, it can be seen that, for example, when the additional actuator is physically removed from the beam, the system performance will be similar to that presented in Section 4. This leads, equivalently, to the conclusion that if a fault develops on the additional actuator the remedial action is to use the functional actuator that is located at the free end to correct the fault condition to a similar situation as that obtained when both actuators were in operation.

6. Conclusions

The prime aim of this work is to achieve active vibration suppression on a flexible cantilever system using fuzzy logic technique. The fuzzy controller has been tested on FD beam simulation. Results have demonstrated successful implementation of the control strategy for canceling the vibration throughout the beam length. It is observed that about 33.33 dB attenuation has been achieved over the first three mode frequency range when the excitation is a unit step using single control actuator. Although it has been noted that when additional control actuator is deployed, the level of cancellation is improved as well as having the ability to compensate for faults which may arise in any individual actuator during operation. In this way the functionality and performance of the system can be maintained as close as possible to the situation for the un-failed condition.

Moreover, a difficulty has been faced when obtaining the appropriate values of fuzzy membership functions where extensive simulation trials are needed to achieve the desired FLC control performances. To improve the situation, the use of GAS techniques to automatically search these functions may be proposed, and this will be discussed in a separate paper. Finally it can be concluded that the fuzzy logic controller do offer a viable solution for vibration problems in flexible beam structures.

7. References

[1] Al-assaf Y, Arabiat H, *Adaptive Fuzzy Logic Control*, Mu'tah Journal For Research and Studies, Vol. 10, No. 3, pp. 109-128, 1995.
 [2] Al-Dmour A S, *Active Controllers for Vibration Suppression in Flexible Beam Structures*, Ph.D Thesis, University of Bradford, 1996

- [3] Alghannam F N, *Parallel Computing for Simulation of Vibrating Beam Structures*, Ph.D. Thesis, University of Bradford, 1995.
- [4] Balas M J, *Modal Control of Certain Flexible Dynamic Systems*, IEEE Conference on Decision and Control, pp. 237-241, 1979.
- [5] Balas M J, *Modal Control of Certain Flexible Dynamic Systems*, IEEE Conference on Decision and Control, pp. 237-241, 1979.
- [6] Ghazali A B, *Advanced Controllers for Building Energy Management Systems*, Ph.D. Thesis, University of Bradford, 1996.
- [7] Higgins H M and Goodman M, *Fuzzy Rule-Based Networks for Control*, IEEE Transactions on Fuzzy Systems, Vol. 2, No. 1, pp. 82-88, 1994.
- [8] Kourmoulis P K, *Parallel Processing in the Simulation and Control of Flexible Beam Structure Systems*, Ph.D. Thesis, University of Sheffield, 1990.
- [9] Kung Y. Liaw C, *A fuzzy Controller Improving a Linear Model Following Controller for Motor Drives*, IEEE Transactions on Fuzzy Systems, Vol. 2, No. 3, pp. 194-220, 1994.
- [10] Meirovitch L, *Elements of Vibration Analysis*, McGraw-Hill, Inc., 1986.
- [11] Tse F S, Morse I E and Hinkle K T, *Mechanical Vibrations*, Allyn and Bacon, Inc., 1978.
- [12] Virk G S and Alghannam F N, *Finite Differences and Finite Element Methods for Simulation of Cantilever Beam Systems*, Research Report 538, University of Bradford, 1994.
- [13] Wang L, *Stable Adaptive Control of Nonlinear Systems*, IEEE Transactions on Fuzzy Systems, Vol. 1, No. 2, pp. 146-155, 1993.
- [14] Zadeh L A, *The Concept of a Linguistic Variable and its Applications Approximate Reasoning*, Information Sciences, Vol. 8, pp. 199-249, 1975.

Appendix A: Beam data

A.1 Cantilever beam parameters

The data for the beam used in the research described in this thesis is as follows:

Beam material: Aluminum

Beam length, l : 0.8 m

Cross section area, A : $2.1894 \times 10^{-5} \text{ m}^2$

Mass per unit length, ρA : 0.05933274 Kg/m

Shear, EI : 0.100105598 Nm²

Beam constant, $\mu^2 = \frac{EI}{\rho A}$: 1.687189872 m⁴ sec⁻²

A.2 Cantilever Beam Nodes and Anti-nodes

Tables A.1, A.2 show the location of the cantilever beam's nodes and anti-nodes as measured from the clamped end.

Table A.1: Locations of nodes along the cantilever beam

Mode	Node distance				
	0				
1	0				
2	0	0.78l			
3	0	0.51l	0.87l		
4	0	0.36l	0.64l	0.90l	
5	0	0.28l	0.50l	0.72l	0.92l

Table A.2: Locations of anti-nodes along the cantilever beam

Mode	Anti-node distance				
1	l				
2	$0.47l$	l			
3	$0.30l$	$0.69l$	l		
4	$0.21l$	$0.51l$	$0.78l$	l	
5	$0.16l$	$0.39l$	$0.61l$	$0.83l$	l