

1-12-2021

## Augmentation of the Performance of Solar Regenerator of Open Absorption Cooling System.

Abdelnabi Bayoumi Kabeel

*Mechanical power Engineering., Tanta University, Faculty of engineering, Thermal engineering,*  
kabeel6@hotmail.com

Follow this and additional works at: <https://mej.researchcommons.org/home>

---

### Recommended Citation

Bayoumi Kabeel, Abdelnabi (2021) "Augmentation of the Performance of Solar Regenerator of Open Absorption Cooling System.," *Mansoura Engineering Journal*: Vol. 29 : Iss. 2 , Article 14.  
Available at: <https://doi.org/10.21608/bfemu.2021.138759>

This Original Study is brought to you for free and open access by Mansoura Engineering Journal. It has been accepted for inclusion in Mansoura Engineering Journal by an authorized editor of Mansoura Engineering Journal. For more information, please contact [mej@mans.edu.eg](mailto:mej@mans.edu.eg).

## AUGMENTATION OF THE PERFORMANCE OF SOLAR REGENERATOR OF OPEN ABSORPTION COOLING SYSTEM

تحسين أداء مولد شمسي للدورة المفتوحة التبريد بالامتصاص

*A. E. Kabeel*

Faculty of Engineering, Mechanical power Department,  
Tanta university, Egypt  
E-mail kabeel6@hotmail.com

### ملخص البحث

في دورة التبريد بالامتصاص باستخدام الطاقة الشمسية يعتبر المولد من العناصر الأساسية والمهمة في الدورة. في هذا البحث تم تصميم وبناء مولد شمسي بحيث يمر الهواء في اتجاه عمودي على سريان المحلول حيث يتساقط المحلول على سطح المولد وهو عبارة عن قماش أسود معرض لأشعة الشمس. للمقارنة تم تصنيع مولد شمسي آخر بنفس مواصفات المولد الأول ولكن يتم نزع الرطوبة من المحلول بطريقة طبيعية على عكس الآخر الذي يتم نزع رطوبته بامرار تيار الهواء العمودي على اتجاه السريان وقد تمت الدراسة عند كميات هواء مختلفة وقد أوضحت الدراسة أن الكفاءة تتسن مع المولد الذي يمر عليه الهواء وتزيد بزيادة الكمية وقد أوضحت النتائج أن تركيز المحلول المستخدم ذو أثر كبير جدا على الكمية المتبخرة لذلك تم استنتاج علاقة تربط بين كفاءة النظام والتركيز في الحالتين وتم حساب معامل انتقال الكتلة للحالتين وقد تم أيضا دراسة البارامترات الأخرى للنظام.

### Abstract

In open cycle liquid desiccant air conditioning, the solar collector regenerator is one of the effective ways of regenerating liquid solution. In this work, the regeneration of liquid solution using cross flow of air stream with flowing film of desiccant on the surface of a solar collector/regenerator has been investigated. To evaluate the effect of cross flow of air stream on the performance of the unit two identical units are constructed and tested in the same conditions of operation. One of the two units is augmented with air blower. The absorber plate is a black clothe layer. The forced air stream, which flows a cross the absorber removes the moisture from the liquid solution. The regeneration in the other collector/regenerator unit is free. The results show enhancement of regeneration efficiency for the forced cross flow compared with the free regeneration. The effect of concentration and flow rate on the performance is discussed. Two relations for regeneration efficiency as a function of concentration for the two units are introduced.

**Keywords, solar regeneration, liquid desiccant**

## INTRODUCTION

The open cycle absorption solar cooling system has received much attention due to its low electricity consumption and high feasibility. Since the rate of water evaporation from desiccant gives a direct measure of the system cooling capacity, the regenerator is the main part of the open refrigeration cycle. A schematic of an open solar absorption cooling system is shown in Fig. 1. The weak absorbent solution is heated and subsequently concentrated in the solar collector, which is open to the atmosphere. The strong regenerated solution leaves the collector and passes through a liquid column, to allow the strong solution to go from atmospheric pressure to reduced pressure. Then, the strong solution passes through a regenerative heat exchanger on its way to the absorber, where the strong solution absorbs water from the evaporator, maintaining the low pressure required with the energy supplied by heat from the cold space. The resultant weak solution is pumped from the absorber back to atmospheric pressure through the regenerative heat exchanger and the collector, completing the cycle. An analytical method for calculating the mass of water evaporated from the desiccant solution as a function of climatic conditions has been studied by Kakabyev and Khandurdynev (1969). Its performance is of major concern in development studies by Mullie et al 1974 and Gandhidasan 1983.

Haim et al 1992 performed detailed simulations of two open absorption systems, one with direct regeneration using regeneration/collector, the other with indirect regeneration using solar heated air in packed tower.

A forced flow solar/regenerator is one of the most effective methods of regeneration of the weak liquid solution in an open

cycle liquid desiccant air conditioning using solar energy. Alizadeh et al 2001 studied the performance of forced flow solar collector/regenerator using liquid desiccant. The weak solution flows over the absorber as a thin film and the forced air stream flows parallel or counter to the solution. In the same cases, the liquid desiccant dehumidifier can work with an evaporation cooler to meet the complete cooling load. During the process of dehumidifying the incoming air stream, the liquid desiccant also useful in cleaning the air of airborne dust and bacteria. Clean, dry air is important in many applications such as hospital rooms and crop drying. Samanet 1987 studied the effect of forced flow collector/regenerator on the performance.

Most experimental studies were performed for natural convection collector. Gandhidasan 1984 had reported a theoretical study and concluded that the forced convection collector/regenerator may perform better than that of natural convection.

Ru Yang et al 1994 conducted an experimental study on the performance of a forced convection solar collector/regenerator for the open cycle absorption using LiCl. The results show that the counter flow case can improve the collector/regenerator efficiency.

In the present work the thermal performance of a forced cross flow solar collector/regenerator and free convection were carried out. The air stream flows a cross the absorber for the first unit. The Calcium Chloride ( $\text{CaCl}_2$ ) solution with different concentrations flows upon the absorber surface. The effect of the different parameters such as amount of flow rate and concentration on the evaporation rate and regeneration efficiency were evaluated..

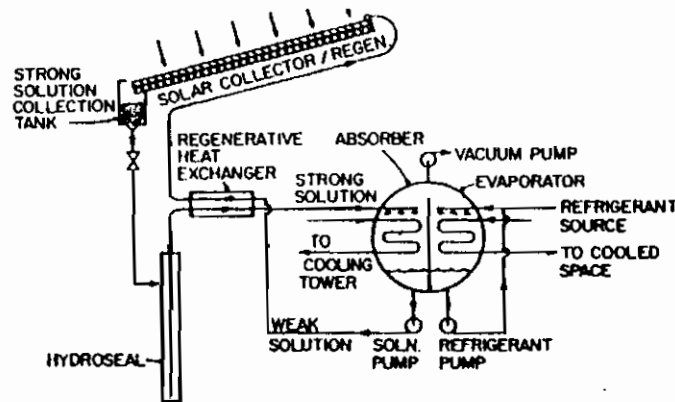

Fig. 1: Open cycle absorption system (Collier 1979)

### EXPERIMENTAL SET UP

The layout and photograph of the experimental set-up are shown in figures (2-a) and (2-b). Two identical regenerator units with the same shape and dimensions are used. The absorber surface has dimensions of 0.6 m x 1 m. It is made of the black layers of cloth. One of the two units is augmented with blower (7) and duct (9). To control the air flow rate valve (8) is fitted in the duct branch. The interior of the duct used is divided into small passages to insure even flow distribution. Weak aqueous solution  $\text{CaCl}_2$  is supplied from tank (1) to the upper end of the absorber surface through a PVC spray header. At the lower end, the regenerated strong solution is collected in a PVC tube and collected into tank (5). The forced air stream velocity is measured. An anemometer is used for velocity measurements at different points of the duct cross section and then the mass flow rate of air is calculated.

Hourly values of the mass of evaporated water from desiccant solution film are evaluated by measuring solution flow rate at inlet and solution concentration at regenerator inlet and exit. The solution flow rate was obtained by measuring the variation of the solution height in the tank

with time. To evaluate the density of solution, sample of solution is taken out at regenerator inlet and exit for the two units, its weight of a given volume is measured.

The solution concentration at inlet and outlet from regenerators is determined by measuring density and temperature and then using  $\text{CaCl}_2$  tables to find the corresponding concentration. (Zactsev 1988, Hawlader 1992 and Saito 1999)

Solution temperature at inlet and exit, bed temperature and ambient temperature for the two experimental units are recorded during the daytime using thermocouples. The solar radiation intensity was measured every hour by using short circuit D.C current of calibrated solar cell using digital multimeter.

To attain steady state flow of desiccant solution on the regenerator surface, liquid solution is allowed to flow for one hour before data collection. During this transient period of operation, the surface of the cloth layers is completely wetted and uniform distribution of the liquid on the black surface is observed. Different values of weak solution concentration are used in this experimental study.

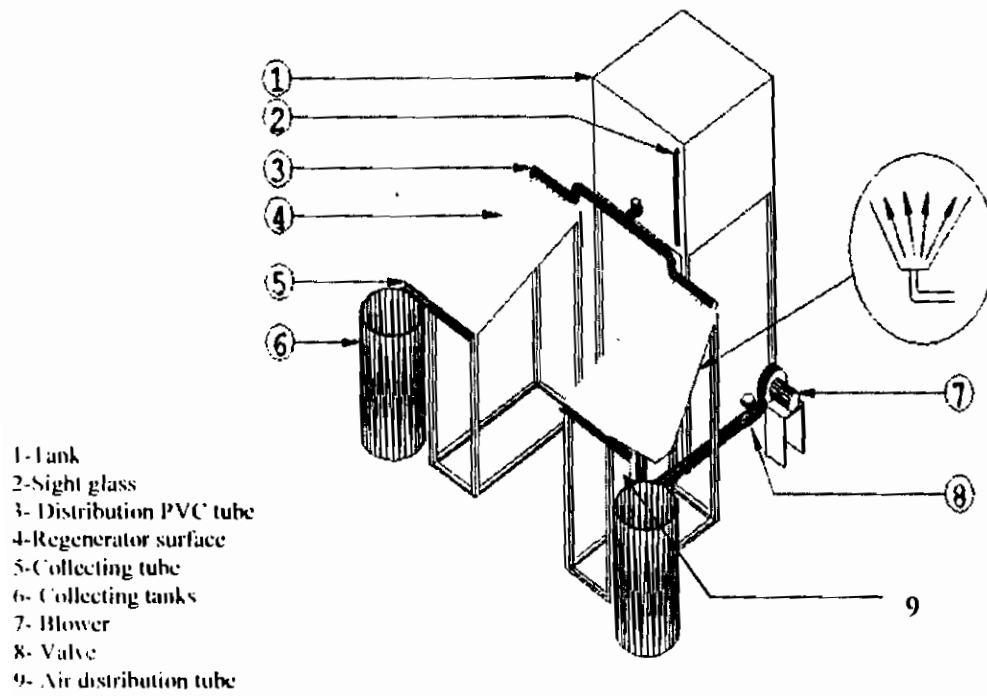

Fig. (2-a) Layout of the experimental setup

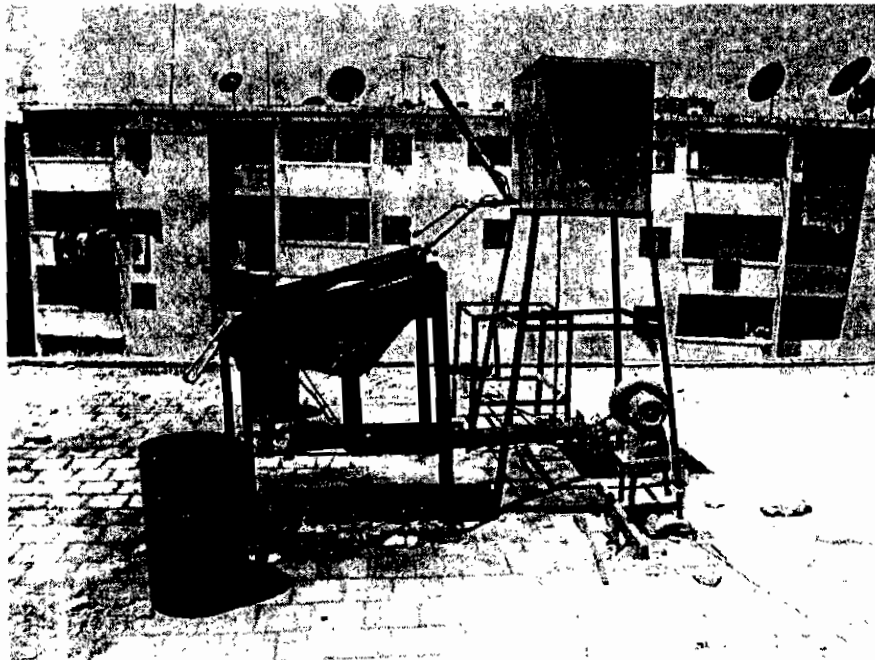

Fig. (2-b): Photograph of the experimental setup

### ANALYSIS OF THE EXPERIMENTAL MEASUREMENTS

The efficiency of regeneration depends on air flow rate and solar radiation intensity. In this analysis the experimental data are used to calculate the regeneration efficiency for the two units. Also the mass transfer coefficient was calculated for the two units.

The inlet mass flow rate can be calculated from the following relation:

$$M_{sout} = M_{sin} \frac{X_{sin}}{X_{sout}} \quad (1)$$

Where;

$M_{sin}$ , solution mass flow rate at regenerator inlet

$M_{sout}$ , solution mass flow rate at regenerator outlet

$X_{sin}$ , solution concentration at regenerator inlet

$X_{sout}$ , solution concentration at regenerator outlet

The evaporated water ( $M_{ev}$ ) obtained as follows:

$$M_{ev} = M_{sin} - M_{sout} \quad (2)$$

From equation 1 and 2

$$M_{ev} = M_{sin} \left[ 1 - \frac{X_{sin}}{X_{sout}} \right]$$

The regenerator efficiency  $\eta_{reg}$  can be defined by the ratio between the energy consumed to evaporate water from the desiccant to the total incident radiation and calculated from the following equation:

$$\eta_{reg} = \frac{M_{ev} h_{fg}}{H} \quad (3)$$

where:

$h_{fg}$ , the latent heat of evaporation of water  
 $H$ , total solar radiation falling upon the regenerator surface

The mass transfer coefficient  $h_m$  is defined as:

$$h_m = \frac{M_{evap}}{L(W_m - W_{atm})} \quad (4)$$

Where:

$W_{atm}$  is the absolute humidity of atmospheric air

$W_m$  is the interface humidity ratio which can be evaluated from the following relation:

$$W_m = 0.622 \frac{P_v}{P_{atm} - P_v} \quad (5)$$

where:

$P_{atm}$  is the atmospheric pressure

$P_v$  is the water vapour pressure of the solution. The vapour pressure on the surface can be obtained by knowing the solution temperature and concentration where it can be calculated from the following relation (Hamed 1999)

$$A(X) = a_0 + a_1 X$$

$$\log(P_v) = A(X) - \frac{B(X)}{t + 111.96} \quad (6)$$

$$B(X) = b_0 + b_1 X$$

Where:

$$a_0 = 10.0624, a_1 = 4.4674,$$

$$b_0 = 739.828, b_1 = 1450.96,$$

$t$  is the solution temperature in C.

### RESULTS AND DISCUSSION:

The aim of the experimental work is to study the effect of forced cross flow on the performance of solar regenerator. Different parameters were studied such as airflow rate and solution concentration of Calcium Chloride solution on the system performance. The weak solution flow rate used in this work is 10 kg/h

Figure 3 shows the typical data for variation of bed temperature, ambient air temperature and solar radiation during the day for the two units. It can be observed that the bed temperature increases with time and reaches a maximum limit in the afternoon. The temperature profile of the bed indicates that the energy is continuously stored in the bed, which will result in increase in the temperature in the afternoon period. The bed temperature of unit 1 (forced cross flow) decreases due to the cold air from the ambient. The solar radiation takes the same trend as that of bed temperature during the day. Also,

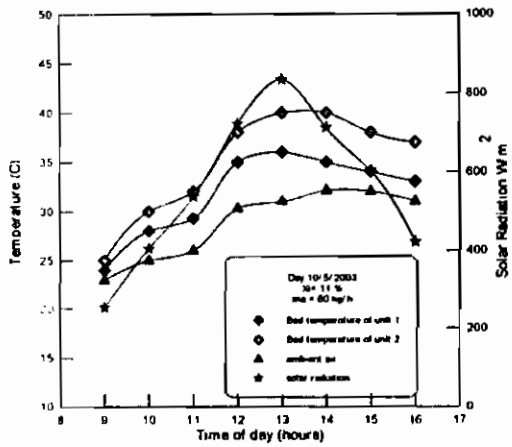

Fig. (3-a)

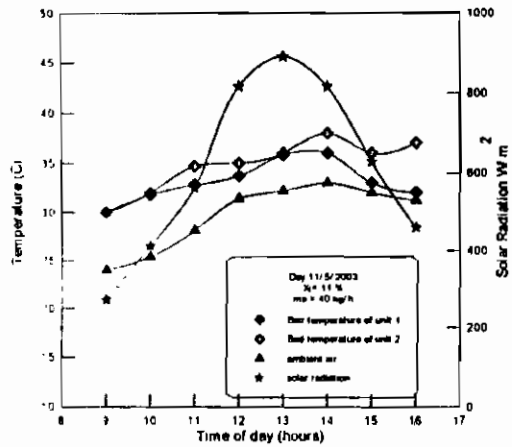

Fig. (3-b)

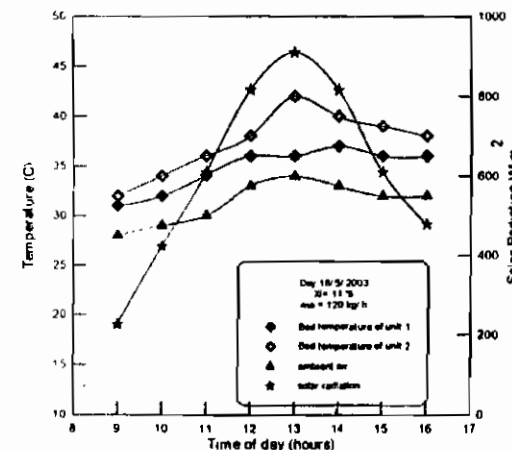

Fig. (3-c)

figures (3-a) and (3-d) show that the bed temperature depends on air flow rate. The bed temperature difference ( difference between the bed temperature of unit 1 and Unit2) reached 5 C at low air flow rate and about 12 C at higher air flow rate.

Figures (3-e) and (3-f) show that the bed temperature increases with increasing the inlet solution concentration. It reaches about 45 C for unit 1 and 40 C for unit 2 at solar noon

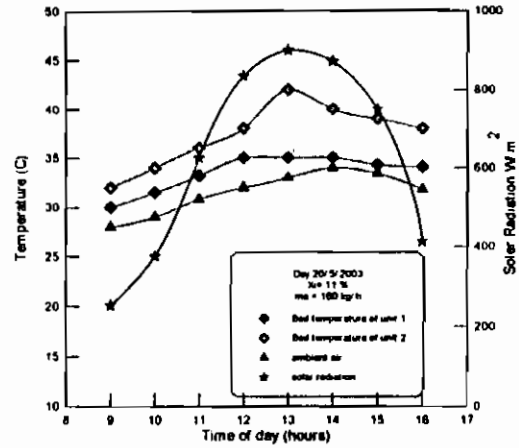

Fig. (3-d)

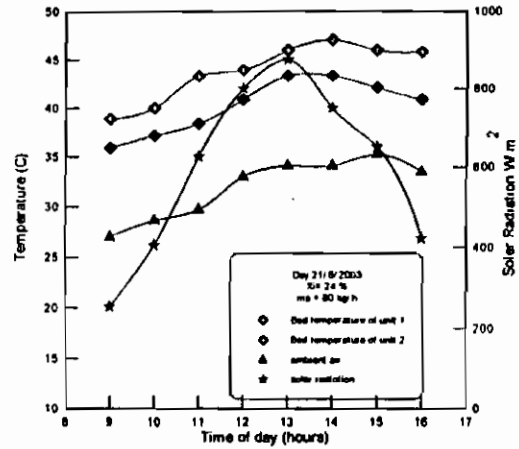

Fig. (3-e)

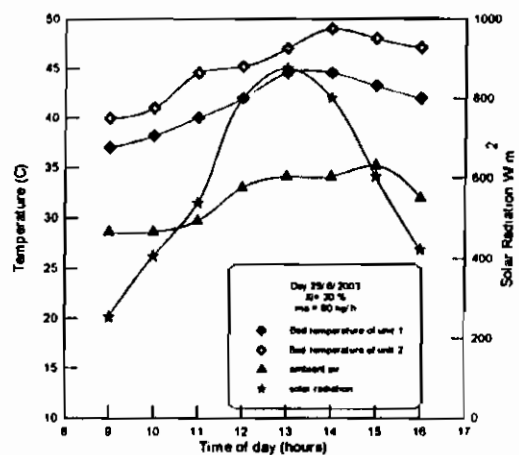
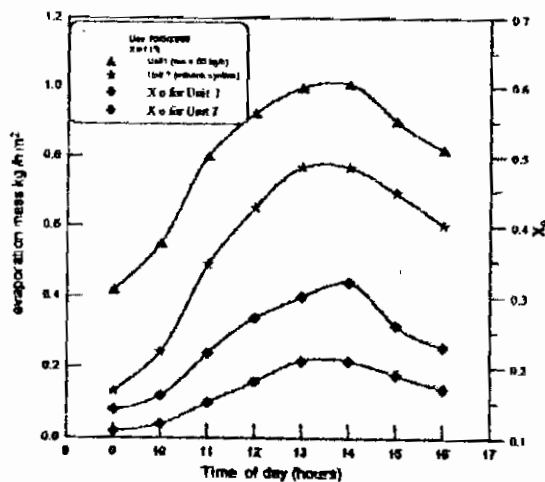

Fig. (3-f)

The effect of forced cross flow at low solution concentration on the evaporation rate is shown in Fig. 4. It can be observed that the evaporation rate increases strongly with increasing solar radiation. In general, the evaporation rate increases with increase of air flow rate. However, for the higher rate of air flow rate (160 kg/h) the rate of evaporation decreases again in Fig (4-c), it can be explained as follows: as the air flow rate increases the mass transfer coefficient is expected to be higher, however the air velocity also affects the generator temperature, which means that an excessive increase in air velocity result in decrease of generator temperature and consequently decrease in the vapour pressure. This may results in decrease in mass transfer potential

The maximum value during the day depends on the value of air flow rate. It reached 1.0 kg/h m<sup>2</sup> at X = 0.11 and at air flow rate m<sub>a</sub> = 80 kg/h and reached 0.95 kg/h m<sup>2</sup> at m<sub>a</sub> = 120 kg/h, reached 0.85 at m<sub>a</sub> = 40 kg/h and reached 1.1 kg/h m<sup>2</sup> at m<sub>a</sub> = 160 kg/h. The figure shows also the variation of the exit solution concentration during the day. It can be observed that the concentration for both regenerators depends strongly on the solar radiation intensity.



Fig(4-a)

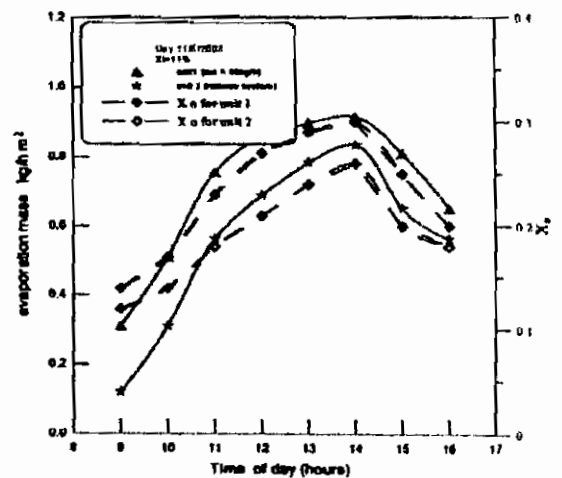

Fig. (4-b)

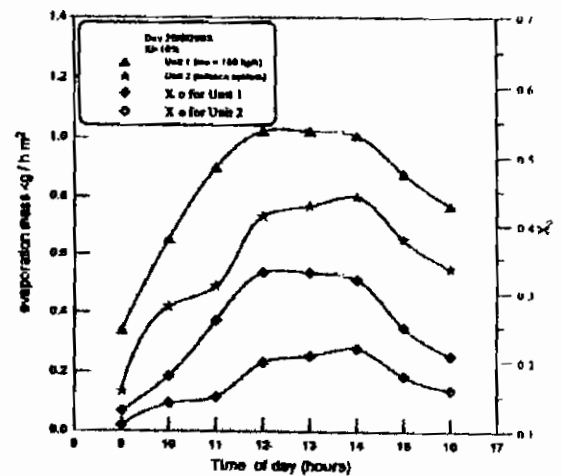

Fig. (4-c)

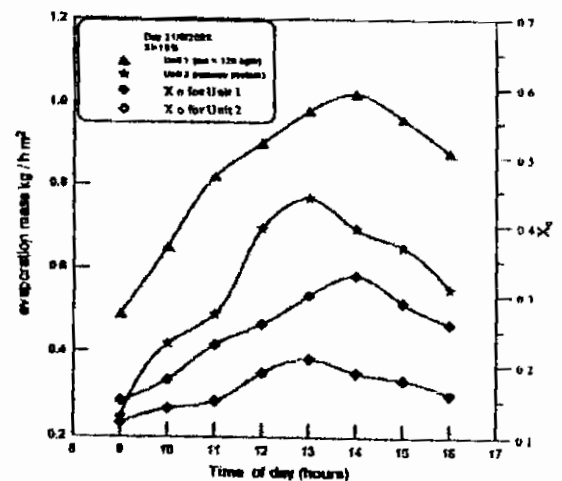

Fig. (4-d)

Fig. (4) The variation of evaporation rate and concentration during the day for low concentrations



Figure 5 shows the variation of the evaporation rate during two days for medium solution concentration (24%, 30%) at the same flow rate (80 kg/h). It can be observed that the evaporation rate increases with decreasing the concentration of weak solution. The evaporation rate of the forced regeneration reaches 0.76 kg/h m<sup>2</sup> at inlet solution concentration of 0.24 and reached 0.6 kg/h m<sup>2</sup> at inlet solution concentration of 0.3. The figure shows that the effect of the inlet solution concentration corresponds to a lower solution vapor pressure, the evaporation rate decreases with increasing inlet solution concentration. Also, the figure shows that the forced convection regenerator unit has a higher rate of evaporation than the natural one. However this difference depends on the inlet concentration.

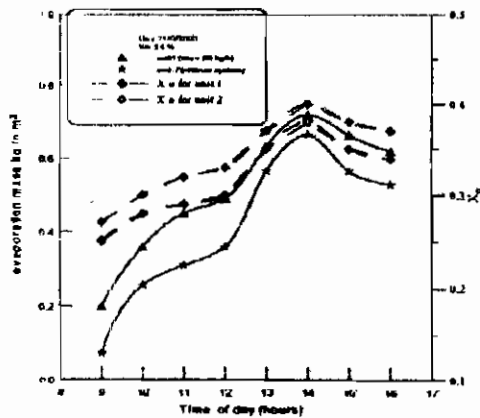

Fig. (5-a)

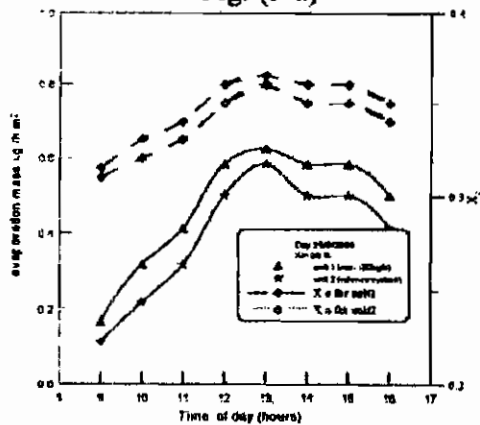

Fig. (5-b)

Fig. (5) the variation of evaporation rate and concentration during the day for  $X_i = 24\%, 30\%$

The variation of the evaporation rate during two days for higher solution concentration is illustrated in Fig. 6.. It can be observed that the evaporation rate decreases with increasing the solution concentration. This is due to the fact that the vapour pressure increases with decreasing in solution concentration and consequently the mass transfer potential also increases. Also, the figure shows that the difference between the forced convection regenerator unit and free unit is small at higher values of concentration. This means that the effect of cross flow at the higher concentration is small.

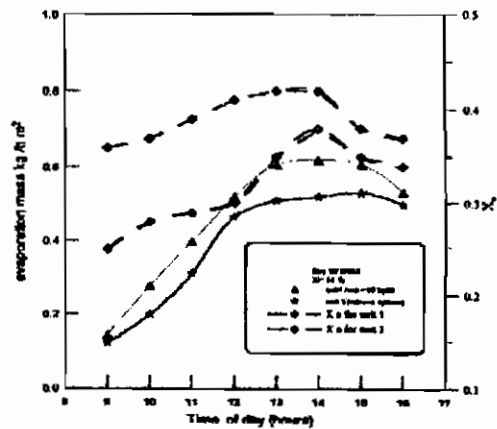

Fig. (6-a)

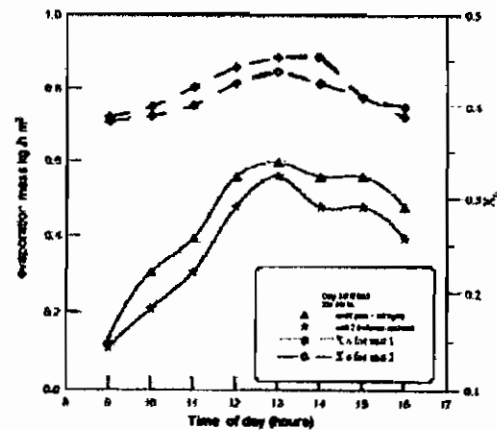

Fig. (6-b)

Fig 6 : The variation of the evaporation rate and concentration at higher inlet concentration

The variation of regeneration efficiency for the two units at different inlet concentrations and different values of flow rate during the day time has been displayed in Fig. 7. It can be interpreted from figures (7-a), (7-b), (7-c) and (7-d) that for a fixed inlet concentration, the efficiency at 1 P.m. reaches 0.66 at  $m_a = 80$  kg/h, 0.63 at  $m_a = 40$  kg/h, 0.78 at  $m_a = 120$  kg/h and 0.79 at  $m_a = 160$ kg/h. Also this figure shows that the forced regeneration has higher efficiency than the natural regeneration. The difference depends on the value of flow rate.

The variation of the regeneration efficiency at medium values of inlet solution concentration (0.24, 0.3) at  $m_a = 80$  kg/h are shown in Fig. (7-e) and (7-f). It can be observed that the efficiency decreases with the concentration increase. It reaches 0.6 at inlet concentration equals 0.24 and reaches 0.56 at inlet concentration equals 0.3. The figure shows also that the forced collector/regenerator has higher efficiency with sensible value at the beginning of the day due to the water extracted with the cross air instead of free solar collector/regenerator which is at low temperature.

Figures (7-g) and (7-h) shows the variation of regeneration efficiency at higher inlet solution concentrations. It can be seen that the efficiency decreases with the concentration increase. Also it is observed that the efficiency difference between the force and free regenerator is small.

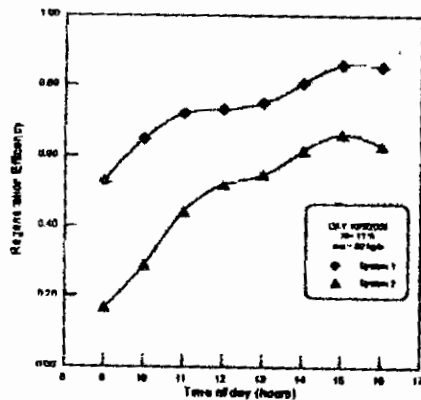

Fig. (7-a)

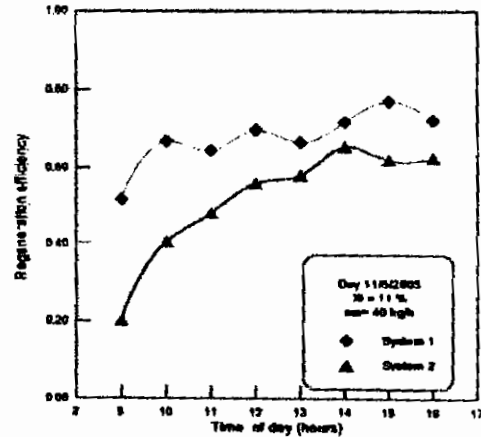

Fig. (7-b)

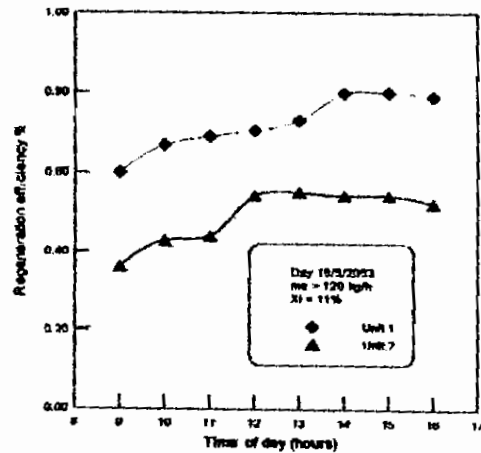

Fig. (7-c)

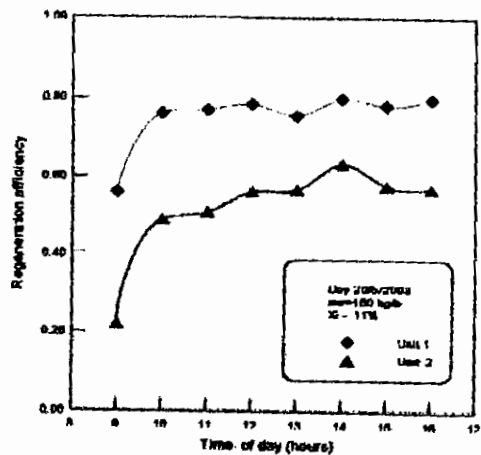

Fig. (7-d)

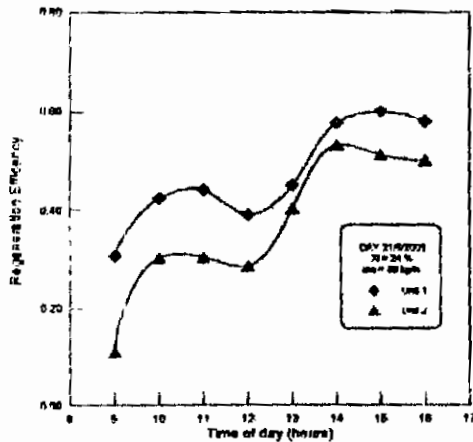

Fig. (7-e)

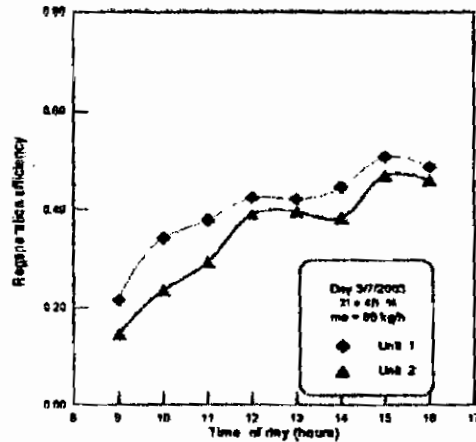

Fig. (7-l)

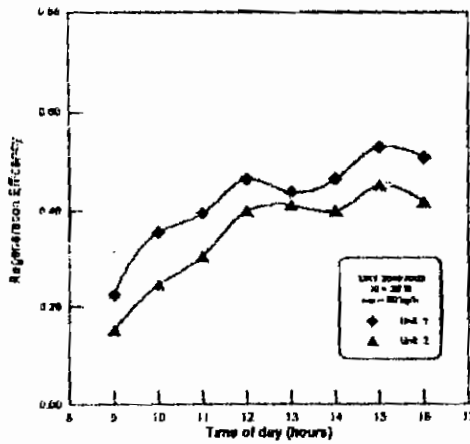

Fig. (7-f)

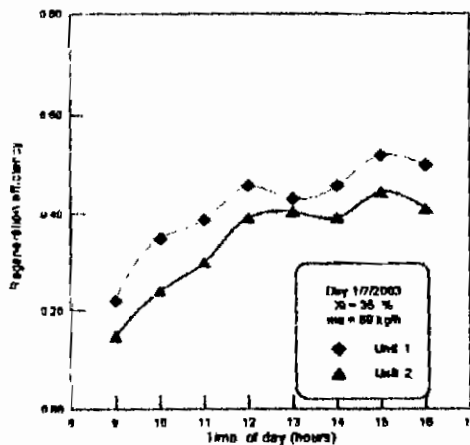

Fig. (7-g)

Fig. 7 The variation of the regeneration efficiency at low , medium and higher inlet solution concentration

The mass transfer coefficient is calculated from equation 4 and represented in Figure 8 for one day as an example. It shows the variation during the day for the two units (free and forced regenerator) used. It can be seen that the mass transfer coefficient for the forced air flow unit is approximately twice that of the free convection unit

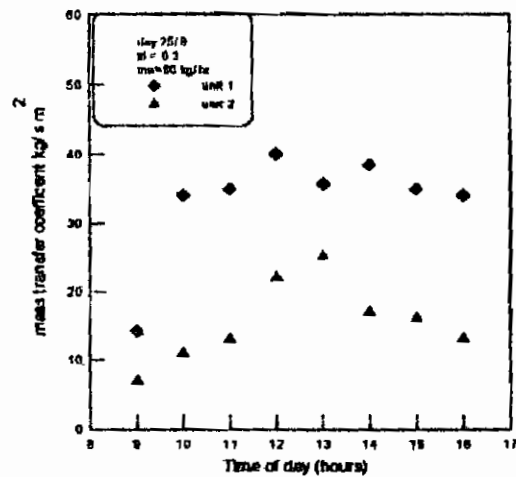

Fig. 8: Mass transfer coefficient for forced and free flow conditions

From the experimental data the average daily efficiency in terms of solution concentration for the forced cross flow regenerator ( $m_a = 80 \text{ kg/h}$ ) and free flow regenerator, respectively (Fig. 9) can be correlated in the following relations.

For forced cross flow regenerator.

$$\eta_1 = 0.3 X_0^{-0.403}$$

For free flows regenerator

$$\eta_1 = 0.25 X_0^{-0.285}$$

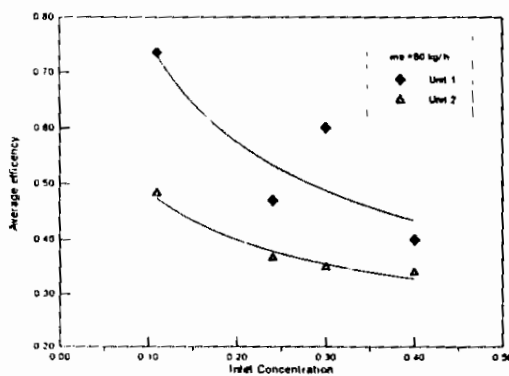

Fig. 9: Average daily efficiency for forced and free flow conditions

## CONCLUSIONS

Investigations are made of forced cross flow of the solar regenerator/collector performance and compared with the free convection solar regenerator collector. The effect of operating conditions such as flow rate and concentration on the regenerator efficiency was studied. The following conclusions can be obtained from the present work:

- 1- Water evaporation rate from the weak solution depends on the solution concentration and forced flow rate.
- 2- The forced convection cross flow solar regenerator has higher efficiency than that of free convection regenerator
- 3- The relations between the regeneration efficiency and concentration were obtained

- 4- The mass transfer coefficient for the forced unit used in this work is higher than that of free unit. With about 200% at flow rate  $80 \text{ kg/h m}^2$

## REFERENCES

- 1- Kakabyev and Khandurdyev: Absorption solar refrigeration unit for open absorption cooling plant with open solution regenerator, *Geliotekhnika*, Vol.5. No. 4, pp. 28-32, 1969
- 2- Saman, W. Y. Said, S. A. and Hanna M. G.: Design and evaluation of a solar regenerator for liquid desiccant system, proceedings ISES Solar world Congress, Hamburg, 1987.
- 3- S. C. Mullic and M. C. Guta: Solar desorption of absorbent solutions. *Solar Energy* Vol. 16, pp. 343-345, 1983.
- 4- Y. Saito: Regeneration characteristics of adsorbent in the integrated desiccant collector, *Trans ASME Journal of Solar Energy Engineering* Vol. 115, pp. 169-175, 1999.
- 5- Gandhidasn P: Simple analysis of a forced solar regeneration system, *Journal Energy* Vol. 6 No. 6 pp.436-437-1982.
- 6- Haim I, Grossman, Shavt. A: Simulation and analysis of open cycle absorption system for solar cooling, *Solar Energy* Vol. 49, No. 6, pp. 515-534, 1992
- 7- Ganhidasan P. : Comparative study of two types of solar regenerators for liquid absorption dehumidification system, *ASHRAE Trans.* 90 Part 2A, pp. 78-84, 1984.
- 8- Ru- Yang, Pai-Luwang: Experimental study of a forced convection solar collector/regenerator for open-cycle absorption cooling, *Trans. of ASME Journal of Solar Energy* 194, Vol. 116, 1994.

- 9- Hamed: Absorption regeneration cycle for production of water from air-theoretical approach, Mansoura University Engineering Journal, Faculty of Engineering Vol. 24, No. 1, M32-M41, March 1999.
- 10- S. Alizadeh and W. Y. Saman: Modeling and performance of a forced flow solar collector/regenerator using liquid desiccant, Solar Energy, Vol. 72, No. 2, pp. 143-154, 2002.
- 11- Zaetsev E.D. and Aseev G.G.: physical-Chemical properties of binary nonorganic solutions, Russian, Khemia, 1988.
- 12- Hawlader M. A. , Stact A. P. and Wood B. : Performance evaluation of glazed and unglazed collector/regenerators in a liquid absorbent open-cycle absorption cooling system, Int. J. Solar energy, Vol. 11, pp. 135-164, 1992
- 13- Collier R.K. : The analysis and simulation of an open cycle absorption regeneration system, Solar Energy 23, . 357-366, 1979.

## NOMENCLATURE

|              |  |
|--------------|--|
| $L$          | collector length, m  |
| $M_{sin}$    | solution mass flow rate at regenerator inlet, kg/h         |
| $M_{sout}$   | solution mass flow rate at regenerator outlet, kg/h        |
| $X_{sin}$    | solution concentration at regenerator inlet[-]             |
| $X_{sout}$   | solution concentration at regenerator outlet[-]            |
| $M_{ev}$     | the evaporated water per unit length, kg/h                 |
| $M_s$        | the solution flow rate at inlet kg/h                       |
| $\eta_{reg}$ | the regenerator efficiency [-]                             |
| $h_{fg}$     | the latent heat of evaporation, kJ/kg.k                    |
| $H$          | solar radiation fall upon the regenerator surface, $W/m^2$ |
| $h_m$        | the mass transfer coefficient, $kg/s m^2$                  |
| $W_{atm}$    | the absolute humidity ratio at atmospheric air , [-]       |
| $W_m$        | the interface humidity ratio, [-]                          |
| $P_{atm}$    | the atmospheric pressure mmHg                              |
| $P_v$        | the water vapour pressure of the solution, mm.Hg           |