

12-15-2020

MATLAB Simulation of Three-Phase SCR Controller for Three Phase Induction Motor.

Ali El-Tamaly
King Saud University

A. Alolah
King Saud University

R. Hamouda
King Saud University

Follow this and additional works at: <https://mej.researchcommons.org/home>

Recommended Citation

El-Tamaly, Ali; Alolah, A.; and Hamouda, R. (2020) "MATLAB Simulation of Three-Phase SCR Controller for Three Phase Induction Motor.," *Mansoura Engineering Journal*: Vol. 31 : Iss. 3 , Article 2.
Available at: <https://doi.org/10.21608/bfemu.2020.129932>

This Original Study is brought to you for free and open access by Mansoura Engineering Journal. It has been accepted for inclusion in Mansoura Engineering Journal by an authorized editor of Mansoura Engineering Journal. For more information, please contact mej@mans.edu.eg.

MATLAB Simulation of Three-Phase SCR Controller For Three Phase Induction Motor

نمذجة حديثه للتحكم بالثايرستورز في المحرك التاثيري ثلاثي الطور

Dr. Ali M. Ellamaly

Prof. Dr.: A. I. Alolah

Prof. Dr.: R. M. Hamouda

King Saud University

King Saud University

King Saud University

الخلاصة: - الثايرستورات تستخدم بوسع في عديد من تطبيقات الكترولونيات القدرة و التحريك الكهربى. و هذا لانها تتمتع بعديد من المميزات كالحجم الصغير نسبيا و توفرها في السوق و سعرها المنخفض. و في هذا البحث تم تحليل و عمل محاكاة تفصيلية للتحكم في جهد الخط لمحرك حتى ثلاثي الطور باستخدام الثايرستورات. و تم التحكم في جهد العضو الثابت للمحرك بالتحكم في زاوية الوجه للمصدر ثلاثي الطور. و قد تم عرض و دراسة تاثير التوافقيات الموجودة في جهد الخط و التيار. و قد عرضت الدراسة ان هذه الطريقة مناسبة للتطبيقات التي تتطلب عزم و سرعة منخفضة. و قد انخفض سريعا كل من معامل القدرة و الكفاءة و العزم الاقصى للمحرك مع الجهود الصغيرة. تم دراسة متطلبات الإشعاع و حدود التحكم للنظام. و قد تم استخدام برنامج حديث لصل محاكاة للنظام و هو برنامج PSIM6.1. وجد توافق بين نتائج المحاكاة من هذا البرنامج مع نتائج المحاكاة من برنامج MATLAB 7.

Abstract: Thyristors are now widely used in many power electronics and motors drives applications. This is due to their several advantages such as relatively small size, low losses, market availability, and low cost. In this paper, a stator voltage control of three-phase induction motor by using thyristors is analyzed and simulated in details. The stator voltage has been controlled by phase angle control of three-phase supply. The effect of harmonic distortion in the line voltage and current have been studied and shown. The study reveals that, this method is suitable for applications requiring a low torque and low speeds. The power factor, efficiency and torque capability of the motor drop dramatically for lower voltages. Firing requirements and limits of control have also been studied. Recent PSIM6.1 program has been used to simulate the whole system. The simulation results from PSIM6.1 have been found in correlation with their counterpart from MATLAB 7.

Index Terms: Voltage controller, induction motor, speed control.

I. INTRODUCTION:

In the last decades, the production of power electronics switches has been plentiful and diverse. Some of these switches are thyristors, GTO's, bipolar power transistors, MOSFET's, IGBT's and MCT's [1,2]. Even with these devices, the basic thyristor still constitutes a robust, simple and economical device that has many applications. Thyristors are widely used for control of power in both AC and DC systems. This is due to their several advantages such as relatively small size, low losses and fast switching. Apart from many other uses, such a controller is used to control the three-phase AC power in induction heating, light control, reactive power control and starting as well as speed control of AC motors.

Three phase AC voltage controller has been used with $R-L$ load [1,2] for various circuit configurations. This technique can be modified to be used with induction motor by reducing the equivalent circuit of induction motor to be just R and L [3]. Three-phase AC voltage controller used with three-phase induction motor is shown in Fig. 1.

Using of Three phase AC voltage control in speed control of induction motor has disadvantages such as low efficiency due to extra the rotor copper

losses. Although it has these disadvantages, but generally, this scheme has some advantages on other aspects, including low cost in installation, ease to maintain and reliable which make this scheme popular option in industry. This scheme has been used in many industrial applications as in drive an overhead traveling crane, an elevator speed control

system [5], and starting and stopping means for induction motor [4-7].

In reference [4] a signal from the rotor voltage and current are used to control the speed and torque respectively. But the main disadvantage of this technique is not applicable for squirrel cage induction motor, moreover the control of current without any reference to the power factor leads to a rather nonlinear torque/speed characteristic. In reference [5] a tachometer generator connected to three-phase squirrel-cage induction motor to generate a speed signal representing the actual speed of the induction motor to compare it with command speed signal to produce a suitable firing signal. In reference [6] and [7] the three phase AC controller with cycle skipping method to control, start, and stop the three-phase induction motor.

II. SYSTEM MODELING

Many researches analyzed the three-phase AC controller under induction motor load to obtain mathematical and programmable form for the variation of torque, speed and line currents along with firing angle. A detailed analysis for induction machine by using reference frame theory has been carried out in [8,9] to obtain the variation of the torque and currents with the variation of input voltage. This technique has been used for single frequency balance three-phase supply but it can be extended to deal with variable frequency, unbalanced three-phase supply. This technique does not deal with the variation of the motor performance as the harmonic distortion in phase voltages.

In this research modeling of induction motor has been carried out by reducing its equivalent circuit to be $R-L$ load. Then, MATLAB program has been used to obtain all performance parameters in terms of its firing angle. A modern computer simulation program (PSIM6 [10]) has been used to validate the MATLAB simulation results.

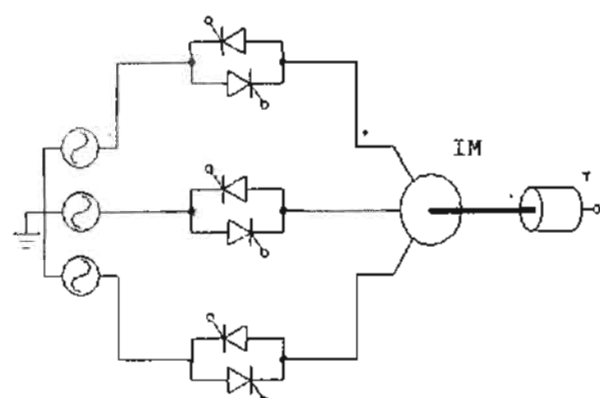

Fig.1 Three-phase AC voltage controller for 3-ph induction motor.

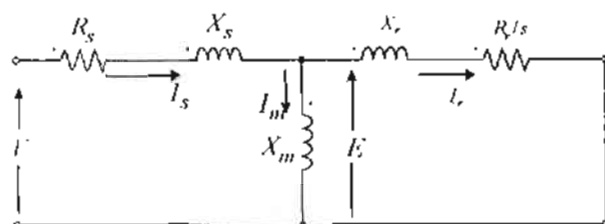

Fig.2 Equivalent circuit of three-phase induction motor

A. R-L Modeling

The simplified equivalent circuit of an induction motor is as shown in Fig.2. The total impedance can be expressed as shown in (1). This equation can be reduced to be just R and L elements in terms of slip as shown in (2) and (3) respectively.

$$Z = Z_s + \frac{Z_m * Z_r}{Z_m + Z_r} \quad (1)$$

$$R = \frac{R_s + \left(\frac{X_m^2 * R_r}{X_m + X_r} \right)}{s} \quad (2)$$

$$X_r = X_s + \left(\frac{X_m R_r^2}{s^2} + X_m X_r (X_m + X_r) \right) + \left(\frac{R_r / 2}{X_m + X_r} \right)^2 \quad (3)$$

Once the total impedance of the motor is found, it could be represented by a three-phase control circuit as shown in Fig.3. After that the analysis shown in [1,3] has been used to determine the supply current and all other performance parameters in the induction motor by using MATLAB computer program.

The analysis and operations of the three phase voltage controller under induction motor load depends on the relative values of firing and phase angles. These different values will make the system works in different modes of operations, namely, mode 2/3, mode 0/2/3 or mode 0/2 [1]. Fig.4 shows the three-phase supply current for different modes of operations.

From intensive simulation results, the firing angle ranges for the three modes of operation have been obtained and summarized as shown in Table(1). It is clear that the mode 2/3 has near sinusoidal current waveform.

Table(1) Modes of operations of the control systems.

Mode	Limits
0/2	$0 \leq \alpha \leq \Phi - \pi/3$
0/2/3	$\Phi - \pi/3 \leq \alpha \leq \Phi_1$
2/3	$\Phi_1 \leq \alpha \leq \Phi + \pi/3$
0/3/2	$\Phi + \pi/3 \leq \alpha \leq 2\pi/3$
0/2	$2\pi/3 \leq \alpha \leq 7\pi/6$

Where, α : is the firing angle.

Φ : The motor power factor angle or, the phase angle of the impedance (i.e. is the phase-angle difference between the phase voltage and the phase current).

Φ_1 : Angle of the input current of the motor under sinusoidal supply current (i.e. it is corresponding to the time between a voltage zero crossing and the instant at which the current fundamental component first reaches zero following voltage zero crossing.)

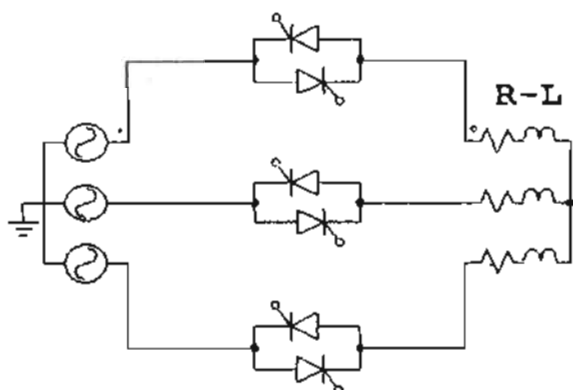

Fig.3 3-ph induction motor with controller represented as R-L load.

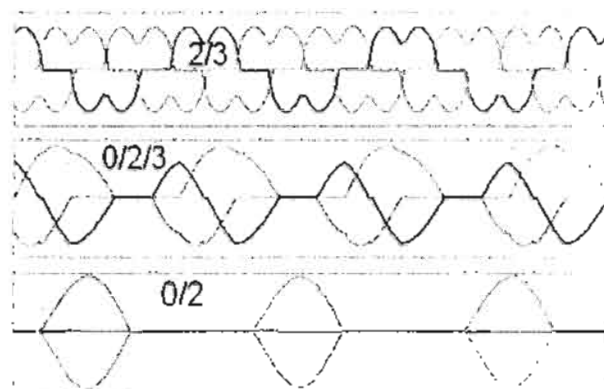

Fig.4 Three-phase currents for different modes of operations.

B. PSIM Computer Simulation

The simulation of three-phase phase angle controller under three-phase induction motor load has been carried out by using PSIM6.1 computer program. Intensive simulation has been carried out for different modes of operations to determine the operating limits

of this system. The nameplate motor data used in this simulation is shown below:

1 kW, 220/380 V, star connection, 3.0A, 4 poles, 1800rpm, 60 Hz, $R_s = 0.0583$ pu, $R_r = 0.0417$ pu, $X_s = 0.125$ pu, $X_r = 0.018$ pu, and $X_m = 1.05$ pu.

III. SIMULATION RESULTS

The simulation has been carried out under three cases of operations. The first case is constant torque variable firing angle (see Fig.5 to Fig.10) while the second case is constant firing angle variable speed (see Fig.11 to Fig.15) while the third case is constant firing angle variable torque (see Fig.16 to Fig.19).

1) Case 1. The variation of phase voltage with firing angle for different values of torque is shown in Fig.5. It is clear that the phase voltage is approximately linear only in the region of mode 2/3 where the phase voltage inversely proportional to the firing angle for all values of torque. The variation of speed with firing angle for different values of torque is shown in Fig.6. This curve reveals that the speed inversely proportional to the firing angle for mode 2/3 and directly proportional in any other mode of operations. So, the speed control system has to identify the mode of operation to send a correct value of firing angle to switches otherwise the system will get out of control.

The variation of power factor with firing angle for different values of torque is shown in Fig.7. It is clear that the power factor inversely proportional to firing angle in no load for all modes of operations. But, at high loads the power factor inversely proportional to the firing angle only in 2/3 mode and directly proportional in any other mode of operations.

The variation of power factor angle (Φ) with firing angle for different values of torque is shown in Fig.8. It is clear that the limits shown in Table(1) agree with the curves shown in this figure. The variation of THD with firing angle for different values of torque is shown in Fig.9. It is clear that the THD is low and direct proportional to firing angle only in mode 2/3. In any other mode of operation except the regions near to mode 2/3 the THD is very high due to the distortion in line currents. The high THD in line currents reduces the efficiency of the motor due to iron and copper losses associated with the current harmonics components as shown in Fig.10.

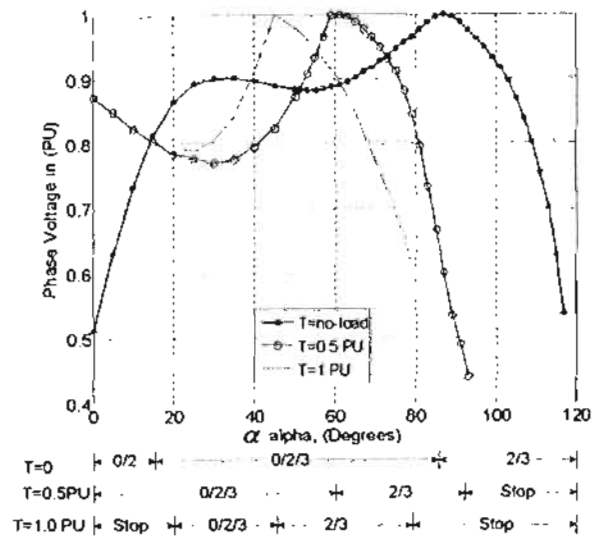

Fig.5 Phase voltage variation for different values of torque

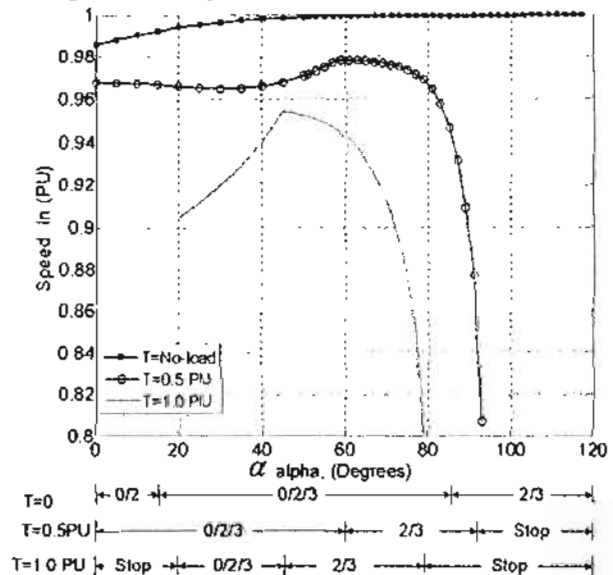

Fig.6 Speed variation for different values of torque.

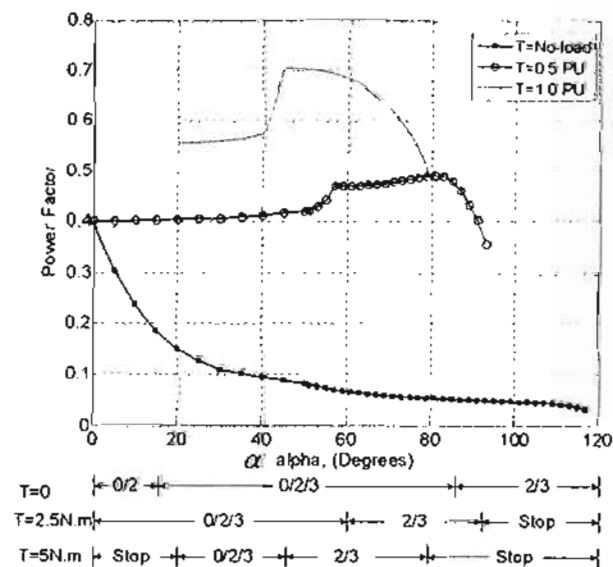

Fig.7 Power factor variation for different values of torque.

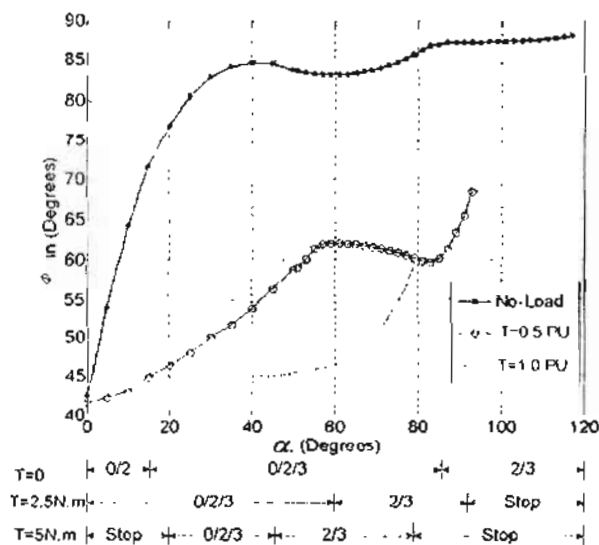

Fig. 8 Power factor angle, ϕ for different values of torque.

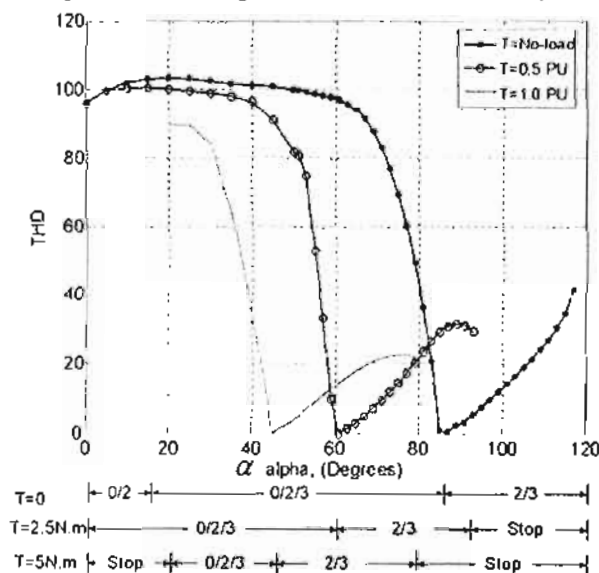

Fig. 9 The THD variation for different values of torque.

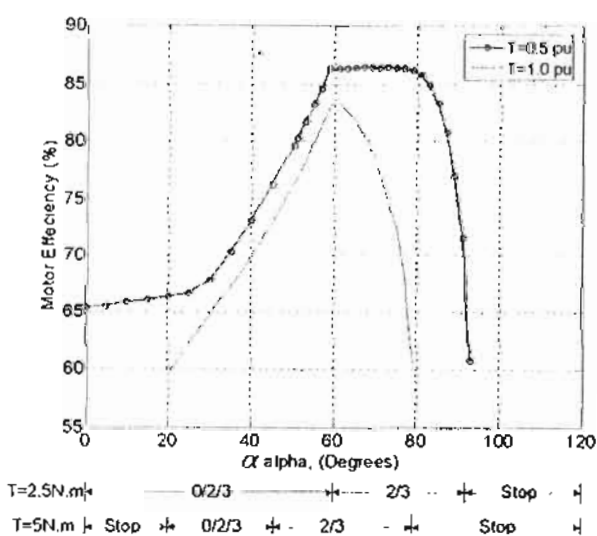

Fig. 10 The motor efficiency for different values of torque.

2) *Case 2:* In this case, three different values of firing angle have been used. These values are 90° , 70° and 50° respectively. The speed has been used as independent variable and changed from 0.25 pu to 1 pu.

The variation of phase voltage with speed for different values of firing angle is shown in Fig. 11. It is clear that the motor works mainly in the mode 2/3 for any firing angle except near to synchronous speed it goes to mode 0/2/3. Phase voltage is inversely proportional to speed at low speed and is directly proportional to speed near to synchronous speed. Phase voltage is high for low firing angle and visa versa.

The variation of torque with speed for different values of firing angle is shown in Fig. 12. The motor torque is directly proportional to speed at low speed and inversely proportional to speed near to synchronous speed. It is clear that the maximum torque increases with decreasing the firing angle values.

The variation of power factor with speed for different values of firing angle is shown in Fig. 13. The power factor is directly proportional to speed at low speeds and inversely proportional to speeds near to synchronous speed.

The variation of THD with speed for different values of firing angle is shown in Fig. 14. The THD is directly proportional to speed at low speed and inversely proportional to speed near to synchronous speed.

The variation of efficiency with speed for different values of firing angle is shown in Fig. 15. It is clear that the efficiency is approximately same in each motor speed for different firing angle.

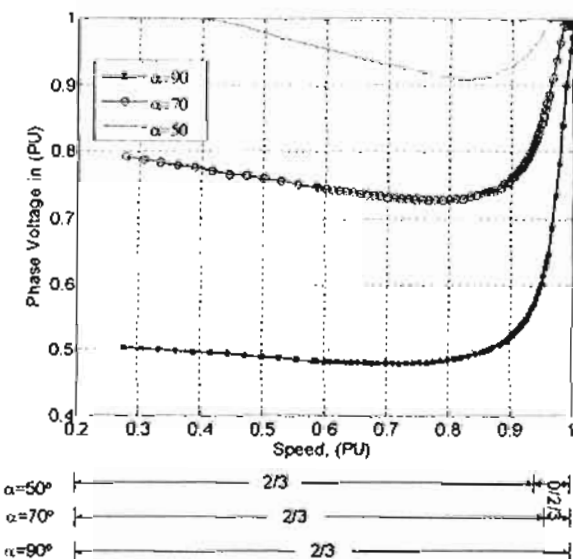

Fig. 11 Phase voltage for different values of firing angle.

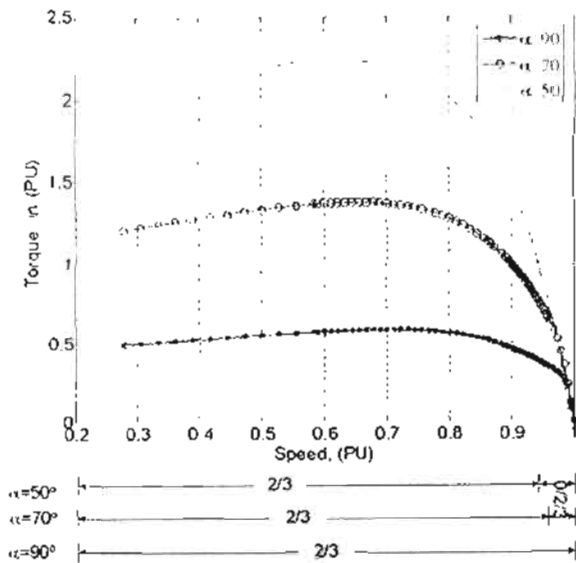

Fig. 12 The motor torque for different values of firing angle

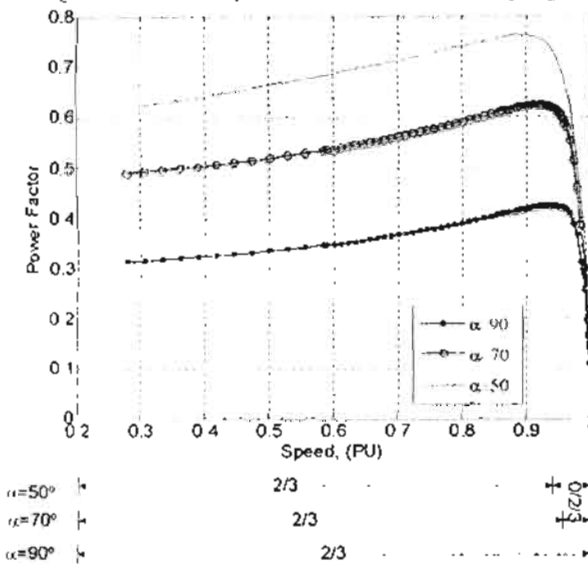

Fig. 13 Power factor variation for different values of firing angle.

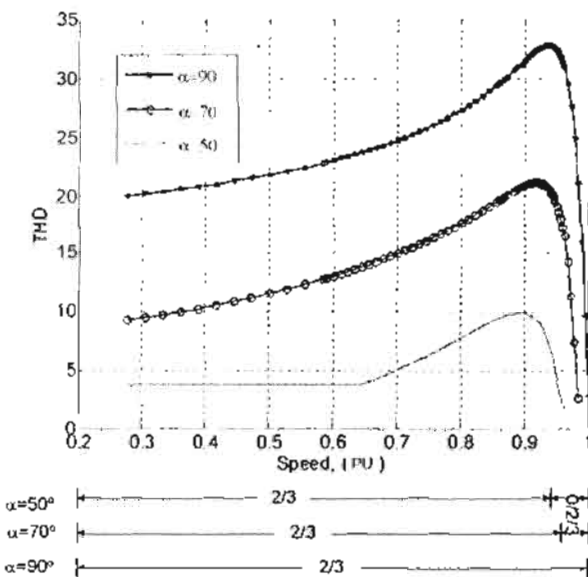

Fig. 14 The THD variation for different values of firing angle.

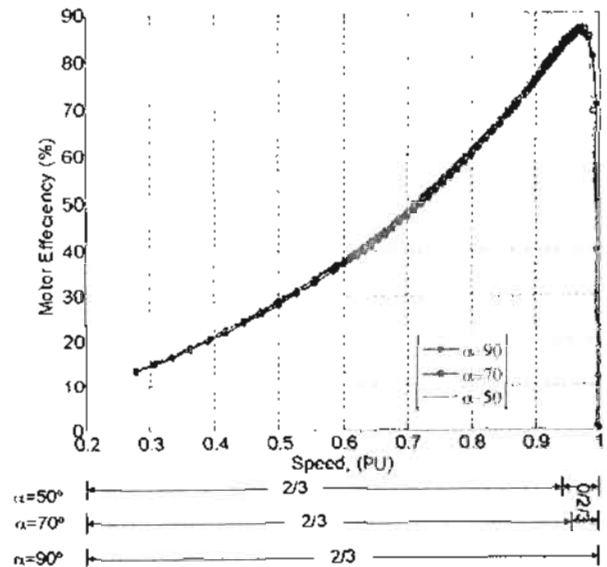

Fig. 15 The motor efficiency for different values of firing angle.

3) Case 3: In this case, three different values of firing angle have been used. These values are 90°, 70° and 50° respectively. The torque has been used as independent variable and changed from no-load to 1pu.

The variation of peak value of phase voltage with torque for different values of firing angle is shown in Fig.16. It is clear that the motor works mainly in the mode 0/2/3 at light loads and low values of firing angles. The motor work goes toward mode 2/3 for high loads and h for any firing angle except near to synchronous speed it goes to mode 2/3 at high values of torque and firing angles. It is also clear that the voltage decreases very fast with increasing load torque especially at high values of firing angle.

Motor speed is inversely proportional to the load torque as shown in Fig.17. The speed decreases very fast with increasing load at high values of firing angle.

Motor efficiency is directly proportional to the load torque at light loads and visa versa for high loads as shown in Fig.18. It is clear that the motor efficiency decrease very fast with increasing load at high values of firing angle due to increasing losses associated with high harmonics.

The variation of THD with torque for different values of firing angle is shown in Fig.18. The THD is inversely proportional to torque at low torque and is directly proportional at high loads when the motor goes to mode 2/3.

The variation of power factor with torque for different values of firing angle is shown in Fig.19. The power factor directly proportional to torque in mode 0/2/3 mode at low speed and inversely proportional to speed near to synchronous speed.

Fig.20 shows the limits of each modes for different motor speed. So, to force the motor to work in 2/3 mode to work in good efficiency and low THD values, it is required to follow the limits of mode 2/3.

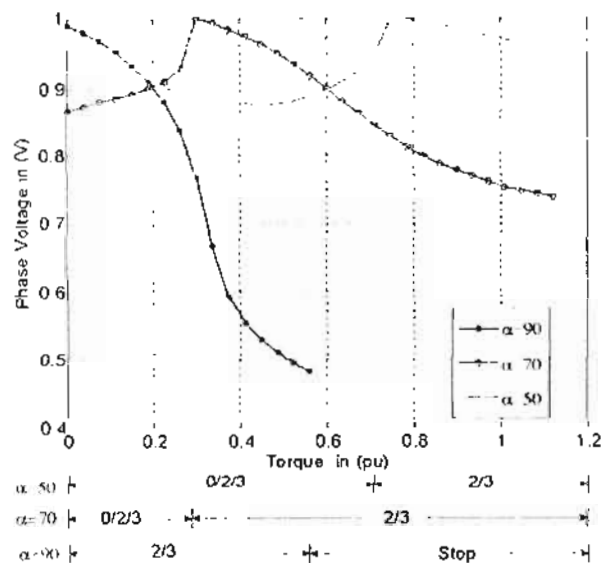

Fig. 16 Phase voltage variation for different values of firing angle.

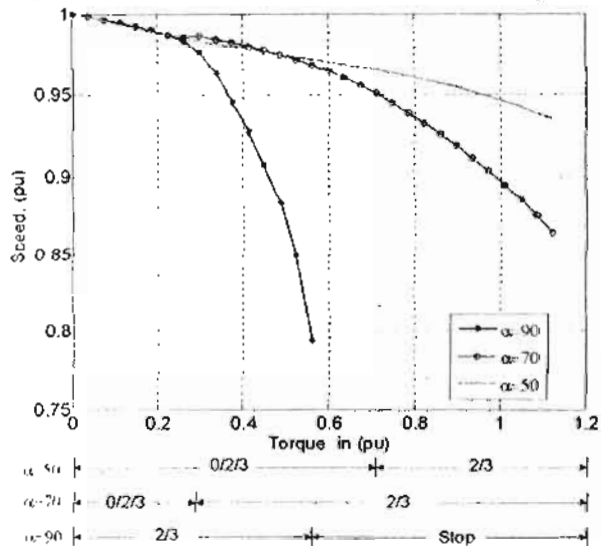

Fig. 17 Speed variation for different values of firing angle

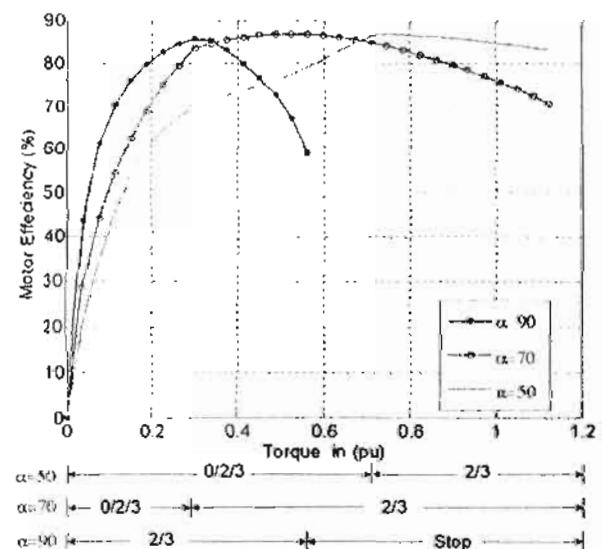

Fig. 18 Efficiency variation for different values of firing angle.

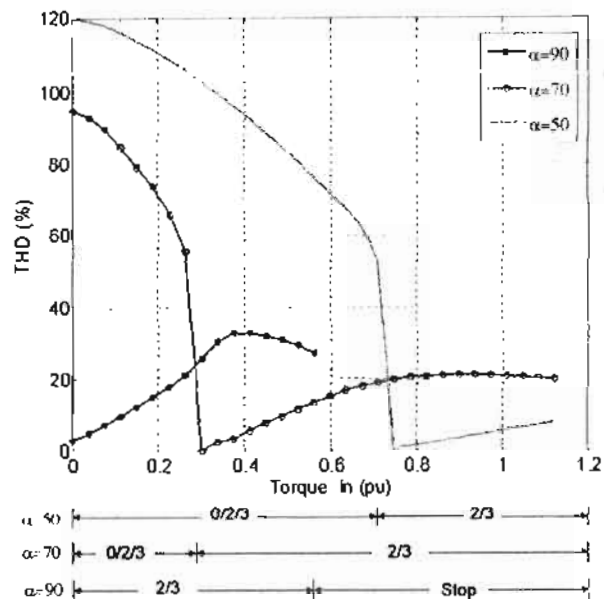

Fig. 19 THD variation for different values of firing angle.

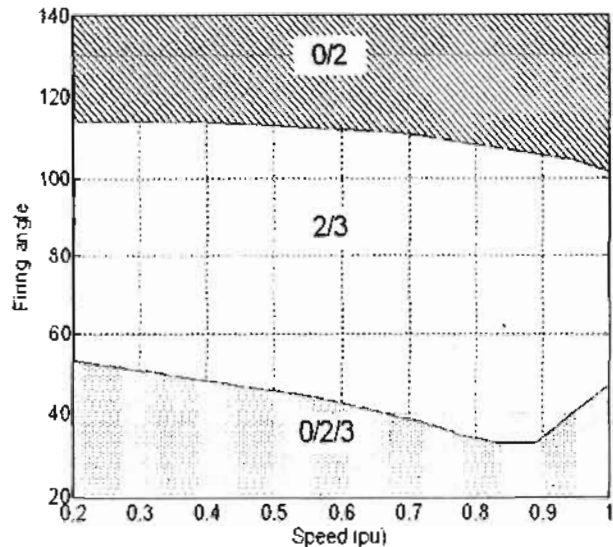

Fig. 20 Limits of each modes for different motor speed.

IV. CONCLUSIONS

This paper presents a modeling and simulation of three-phase AC voltage controller for three-phase induction motor. The simulation results from PSIM6.1 have been found in correlation with their counterpart from MATLAB 7. The speed control of the induction motor is achieved by controlling the firing angle. The relation between the speed of the motor and the firing angle depends on the mode of operation. So, the speed control system has to identify the mode of operation to send a correct value of firing angle to switches otherwise the system will get out of control. Efficiency and THD of the system depends on the mode of operation of the system where their values are good around mode 2/3. So, it is recommended to force the motor to work in this mode of operation and avoid others. The control limits of this system exist over a wide range of delay angle in light loads and visa versa. Simulation results presented in this paper demonstrate the simplicity of this technique.

REFERENCES

- [1] Sheplherd, W. "Thyristor Control of AC Circuits", Book, Lockwood staples Ltd, 1st ed. England, 1975.
- [2] Dubey, G. K., Doradla, S. R., Hosht, A. and Sinha, R. M., "Thyristorized Power Controllers", Book, John Wiley & Sons, India, 1986.
- [3] Hamed, S. and Chalmers, B., "Analysis of variable-voltage thyristor controlled induction motors" *IEE Proc., Vol. 137(3), Pt. B, pp. 184-193, May 1990.*
- [4] Morters et. al. "Control system for regulating the speed of an electric motor" U.S. Patent 4093898, June 1978
- [5] Kumatke, H. "Elevator speed control system" U.S. Patent 4052651, Oct. 1977.
- [6] Rowan, I. M., Merrison, J. C. "Electric motor speed control apparatus and Method" U.S. Patent 4996470, Feb. 1991
- [7] Delange R. J. "Electric motor control apparatus and Method" U.S. Patent 5187419, Feb. 1993
- [8] Lipo, T. A., "Multiple reference frames applied to impedance unbalances of induction machinery-the open circuited stator phase," *IEEE Conf. on Systems, Networks and Computers, Oaxtepec, Mexico, 1971, pp. 312-316.*
- [9] Lipo, T.A., "The Analysis of Induction Motors with Voltage Control by Symmetrically Triggered Thyristors," *IEEE Trans Power Apparatus and Systems*, vol. PAS-90, no. 2, 1971, pp. 515-525.
- [10] PSIM6.1, available. www.powerintech.com