

11-25-2020

## Indirect System for Measuring the Feeding Force and Evaluating the Sewing Parameters.

Adel El-Hadidy

*Professor of Textile Engineering Department., Faculty of Engineering., El-Mansoura University., Mansoura., Egypt.*

Ahmed Samy ElDeeb

*Professor of Textile Engineering Department., Faculty of Engineering El-Mansoura University., Mansoura., Egypt.*

M. Hassan

*Textile Engineering Department., Faculty of Engineering., El-Mansoura University., Mansoura., Egypt.*

N. Mohamed

*Textile Engineering Department., Faculty of Engineering., El-Mansoura University., Mansoura., Egypt.*

Follow this and additional works at: <https://mej.researchcommons.org/home>

---

### Recommended Citation

El-Hadidy, Adel; ElDeeb, Ahmed Samy; Hassan, M.; and Mohamed, N. (2020) "Indirect System for Measuring the Feeding Force and Evaluating the Sewing Parameters.," *Mansoura Engineering Journal*: Vol. 34 : Iss. 1 , Article 3.

Available at: <https://doi.org/10.21608/bfemu.2020.125364>

This Original Study is brought to you for free and open access by Mansoura Engineering Journal. It has been accepted for inclusion in Mansoura Engineering Journal by an authorized editor of Mansoura Engineering Journal. For more information, please contact [mej@mans.edu.eg](mailto:mej@mans.edu.eg).

## Indirect System for Measuring the Feeding Force and Evaluating the Sewing Parameters

نظام غير مباشر لقياس قوة التغذية وتقييم متغيرات الحياكة

El-Hadidy A., ELDeeb A.S., Hassan M., Mohamed N.

Dept. of Textiles Engineering, Mansoura University, Mansoura, Egypt

### المخلص

في هذا البحث تم قياس قوة التغذية على ماكينات الحياكة وتغيير انتظاميتها والتي تعتبر مؤشراً على انتظامية طول الغرزة وذلك باستخدام منظومة حاسب ألي تحت الظروف الفعلية لعملية الحياكة. هذه المنظومة تعتمد على طريقة غير مباشرة وهي قياس الطاقة الكهربائية المستهلكة في القوة اللازمة للتغذية. تم دراسة كلا من متغيرات الماكينة المتمثلة في السرعة وحمل قدم الضغط وكثافة الغرز ونوع الدواسة على قوة التغذية وانتظاميتها من غرزة إلى أخرى كما تم دراسة تأثير متغيرات الحياكة المتمثلة في عدد طبقات القماش واتجاه خط الحياكة. أيضاً تم دراسة تأثير هذه المتغيرات على مسافة الانزلاق بين طبقات القماش وتم الربط بين انتظامية قوة التغذية وانتظامية طول الغرزة عند زيادة عدد الطبقات أثناء الحياكة وتحت تأثير المتغيرات المختلفة.

### Abstract

In this study, the sewing feeding force and its regularity which is an indicator to stitch length regularity were measured using A computer-based measuring systems under the real conditions of sewing process. This system is an indirect method based on measuring the electric power consumption due to fabric feeding. The effect of sewing machine setting in terms of speed, presser foot load and stitch density on the feeding force and its regularity from stitch to another were studied. The effect of sewing parameters in terms of number of layers and sewing line direction were also studied. The effect of sewing machine setting on the distance of slippage between fabric layers and the relation between feeding force regularity and stitch length regularity were investigated.

### 1- Introduction

Apparel industry is the final stage in producing garment textile in which the two dimension flat fabrics is converted to three dimensional products to fit the human body. The conversion is done by the process of disjoining and joining. Disjoining is carried out using mechanical cutting methods as straight knife, circular knife and band knife and it is developed to laser techniques. Joining is done by sewing of fabric using sewing threads through three basic process needling, feeding and interlooping.

Quality control is a basic stage in this industry as the quality is considered to be the basic criterion for consumer acceptance of the products especially fashion apparel which represent 75% of all products. Detecting of sewing seam defects as puckering, broken stitch, needle cutting, seam slippage, skipped stitch, irregularity of stitch line and irregularity of stitch length is a major operation of quality assessment.

### **Fabric friction properties:**

The frictional resistance between woven fabrics were measured using a special modification of the Instron tester. In the modified instrument, a flat plate is fixed to the crosshead and the lower fabric is mounted on the flat plate. A carriage which functions as a holder of the upper fabric is placed on the lower fabric [1].

The influence of fabric structure on the stick-slip motion of dynamic frictional force were studied [2]. The experimental results on the sliding of fabric on metallic and polymeric solid surface showing the influence of the compression load at the solid fabric interface and the nature of the solid material [3]. The interpretation of the non-uniform sliding phenomenon response for the dynamic response for sliding friction through dynamic models based on new topographic details of the fabric surface in front of the leading edge of the sled in movement were given [4]. A new generation of sewing equipment integrating auxiliary add on kits to improve performance and flexibility in the production of high-quality garments [5]. The influence of pressing foot design, pressing force the sewing speed upon the stitch length. [6]. The effect of the fabric to metal surface and fabric to fabric frictional characteristics in both warp and weft directions were studied. The instrument consisted of three measuring devices. The load cell measured the frictional pull on the

upper surface by the moving lower surface [7].

### **Parameters affect the stitch length irregularity:**

A new generation of sewing equipment integrating auxiliary add on kits to improve performance and flexibility in the production of high-quality garments[5]. The influence of pressing foot design, pressing force the sewing speed upon the stitch length were studied [6].

The Influence Of Selected Machine and Material Parameters on the Stitch Length and Its Irregularity were studied [8].

The developing measuring system to measure and analyzes the sewing machine needle penetration torque (NPT) done. The measuring system depended on measuring the change of the electric power under dynamic conditions by using measuring electric circuit and a digital oscilloscope connected to a [PC] computer [9].

From, this review it is obvious that most of the researches use the tensile testing machine (Instron) which has the following disadvantage.

- 1- The maximum speed of the Instron is (100 cm/min) which is less than the speed of the home sewing machine (175 cm/min If its speed 885 s.p.m and stitch density is 5 s.p.cm).
- 2- On the Instron, the motion is continuous but on the sewing machine the motion is intermittent.
- 3- The vibration of the sewing machine is not found on the Instron.

Thus, it was seen that it is important to relate between sewing feeding force and stitch length regularly under the real condition of sewing process in terms of high speed, vibration and intermittent motion.

In order to measure the feeding force under the three real working condition (high speed- vibration -discontinuous motion), as a first step the measuring system which was established to measure the penetration force [9] is modified to get the difference between the power consumption of the sewing machine when a fabric sample is fed and when no fabric sample is fed after stopping the motion of the lopper, the take up lever and the needle bar which given only the power consumption for feeding operation, this measuring system was used on home sewing machine due to its low weight parts and simple basic mechanisms .also the heavy pulley was replaced by a light weight pulley and a direct current (DC) servo motor which always trying to keep its speeds constant by consuming more or less electric power under different mechanical loading was used instead of alternative current (AC).

to specify the sewing machine cycle , An optical system is built instead of the micro switch marker , A computer program is designed to analyze the out put signals from the measuring system.

## 2- Measuring of feeding force based on Power Consumption system

An electronic circuit was built up to measure the change of current intensity consumed on the servo motor as an indication to the change of the feeding mechanical load. A block diagram of the measuring system is shown in figure (1). As shown in this figure a power supply of continuous current with variable voltage control from (0-30)V is used to supply the servomotor therefore, any change in power could be measured as a change in the current intensity (I) and the current could be measured as voltage change across a known resistance connected in series to get the change of the current as a change in voltage which can be recorded by a digital storage oscilloscope, the signal from an optical circuit is simultaneously recorded in the second channel of the digital storage oscilloscope in order to specify the start of the sewing machine cycle .

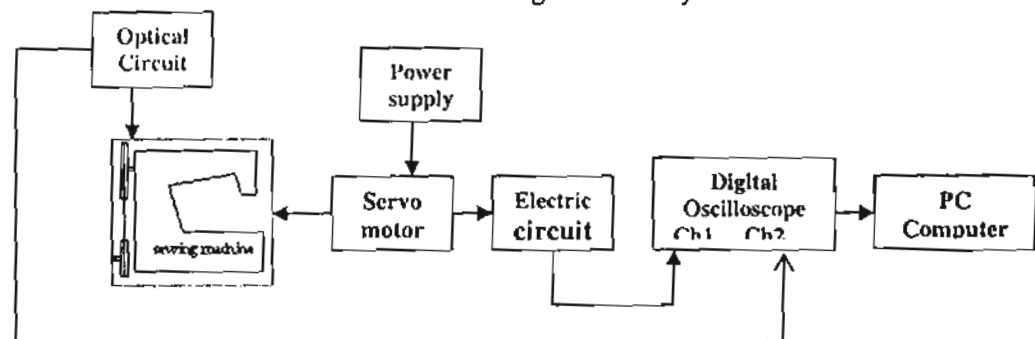

Fig.1 Flow chart of the indirect measuring system

The feeding force could be measured through the following simple equation [\*] :

$$E = I * V = \frac{v}{R} * V = v * \frac{V}{R}$$

Where E = Electronic power

V= Voltage (known value).

v = voltage recorded across resistance R.

I = current which is wanted to be measured.

n =motor speed (r.p.m.) (2.83\* machine speed)

$$\text{Torque} = E / \omega = \frac{v \times \frac{V}{R} \times \zeta}{\omega} = v \times \left( \frac{V \times \zeta}{\frac{2 \times \pi \times n}{60} \times R} \right) \quad \text{Torque} = v * k \quad k = \left( \frac{V \times \zeta}{\frac{2 \times \pi \times n}{60} \times R} \right)$$

Where:  $\omega$  = angular speed,

R = resistance (10) $\Omega$ ,

$\zeta$  = motor efficiency (0.8 - 0.85)

## 2-1 Sewing Machine and servo motor Specifications

Table (1) Sewing Machine Specification

Machine name	: Pfaff
Maximum presser bar left	: 5 mm
Maximum speed	: 800 s.p.m
Motor power (AC MOTOR)	: 90 watt
Max. presser foot force	: 4 Kg

A servomotor is a DC, AC, brushless motor combined with a position-sensing device (e.g. a digital decoder). Servos are extremely useful in robotics. The motors are small and are extremely powerful for their size. The servomotor has some control circuits and a potentiometer (a variable resistor, aka pot) that is connected to the output shaft. The amount of power applied to the motor is proportional to the distance it needs to travel. So, if the shaft

needs to turn a large distance, the motor will run at full speed. If it needs to turn only a small amount, the motor will run at a slower speed. This is called proportional control. In this research a two-wire, DC Servomotor is used with the following specifications:

Type DS 64BE40-2

P/N 127P 280REVF

DC 24 Date 0810

Tokyo Japan

It was better to use a synchronous motor which always keep its speed constant under any load by taking more current but it need another device to start the motion and reach its speed then the motor start to take its role in keeping the speed constant.

## 2-2 Optical system to specify the sewing machine cycle :

The idea of this measuring system is based reflecting radiation which record signal . In order to establish such optical system, a light

source, optical sensor, reflecting object, and a recording unit are needed as shown in fig. 2 .

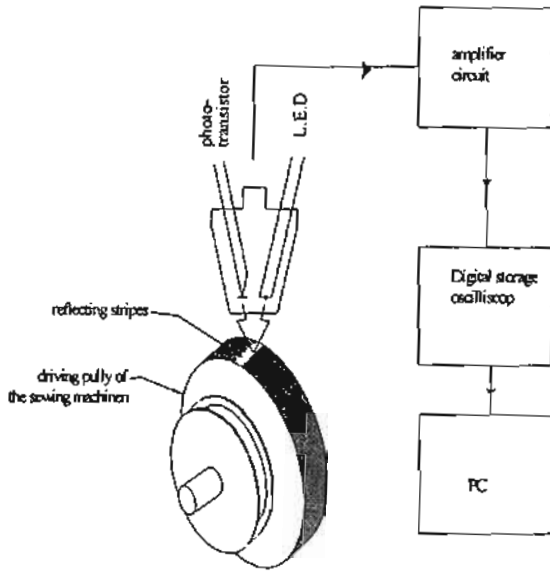

Fig. 2 A diagrammatical sketch of the optical measuring system to specify the sewing machine cycle

### 3-1 The photo sensor:

The photo sensor (Type RS-Standard, stock No. 307-913) used in this system consists of an infra-red emitting L.E.D and a phototransistor sensor housed in a moulded package. The moulded case incorporates a dust cover and an infra red filter to prevent the ingress of dust and eliminate ambient illumination problems. A slotted mounting hole allows for adjustment to the sensing distance. Its operation sensing distance is 4.6 mm [26] The photo transistor responds to radiation from the diode when a reflective object is placed within the field of view depending on the doppler effect discovered by Doppler and named after him (5,7) which

indicates that the frequency of waves is changed by an object in motion

### 3-2 The amplifier circuit

An amplifier circuit was built as shown in fig. 3. The output of the circuit is connected to the first channel of the digital oscilloscope in order to record the signal simultaneously with the output signal of the first optical system.

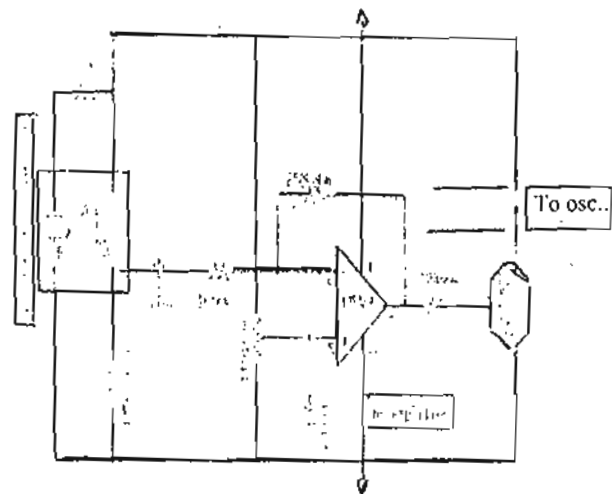

Fig. 3 The amplifier circuit

### 3-3 Reflection Object:

The pulley of sewing machine covering its surface with strong adhesive black paper, one fine metallic reflecting stripe were fixed on the pulley. The recorded output signal from the optical unit is shown in Figures (2-19) where the reflected light from the stripe form a peak in the signal. The time from any peak to the next is equal to the time required to one sewing machine cycle.

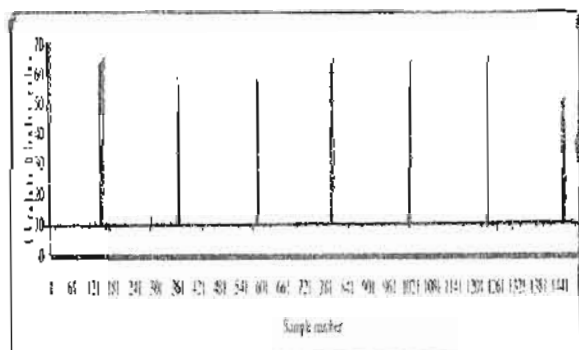

Fig. 4 The output signal from the optical system to specify the sewing machine cycle

The machine speed could be controlled by means of the variable voltage of the power supply which changes the servo-motor rotational speed.

#### 4- Converting the electrical output to a digital signal.

PCS64i which is a digital storage oscilloscope, shown in figure (5) that uses an IBM compatible computer and its monitor to display wave forms figure (6), was used. All standard oscilloscope functions are available in the DOS or Windows operating systems. Its operation is just like a normal oscilloscope with the difference that most operations can be done online with PC. It is used as a data acquisition system by means of converting analog to digital system. It has two channels to record two signals at the same time. Also, summing or subtracting of the two signals can be done.

#### Computer Specifications

The Specifications of the used online PC were as follows: Intel Pentium III processor, 448 MHZ, 128 MB of RAM



Fig. 5 Two channel digital storage oscilloscope (DSO)

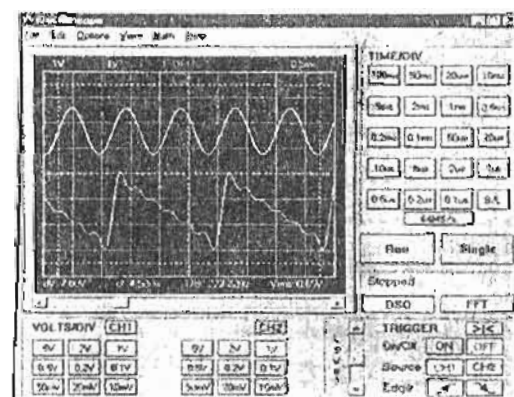

Fig. 6 Windows screen of the DSO program.

The results can be recorded as an image as shown in figure (7) or as a data file as shown in figure (8) which can be then analyzed by computer programs. The oscilloscope records 4096 samples in every one record.

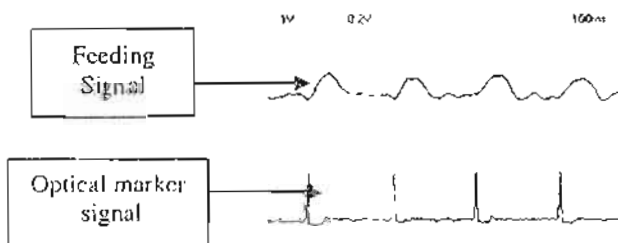

Fig. 7 Saving of signal as image

TIME STEP: 160 = 100ms		
VOLTAGE STEP: CH1: 32 = 1V CH2: 32 = 0.2V		
CH2	CH1	N
87	59	0
87	59	1
88	59	2
89	59	3
88	59	4
↓	↓	↓
122	59	4093
122	59	4094
122	59	4095

Fig. 8 Saving of signal as a text file of 4096 measured points

As shown from the table in figure (8), Maximum 4096 samples are stored for each screen numbered from 0 to 4095 which is displayed in the Column N.

Columns CH1, CH2 are the recorded values on channel 1 and channel 2 respectively. The values are displayed in absolute display value from 0 to 255 where 000= is the bottom of the screen (0 can also mean that the measurement has stopped) and 255 the top of the screen. Time step is the used time to store a number of samples. As shown it takes 100 ms to store 160 samples so it takes  $(59 \cdot 100 / 160)$  ms to store the sample number 3. Voltage step is the volt per division for channel 1 and channel 2. As shown for CH1

value 32 equal 1 volt so the second measured value 09 equal:  $1/32 \cdot 59$  volt.

### 5- Estimating the feeding force value:

Recording out signal at two different cases

- 1- We obtain the machine signal as we connect the conveyer belt. There were a marker and we took the mean values of the signals
- 2- Also we get the machine signal during the feeding operation by taking booth the machine and feeding signals together by connecting the feeding mechanism with putting down the feeding m/z and feeding the fabrics.

To obtain the feeding signal only we subtract the mean values of the machine signals from the machine signals while feeding for every sewing m/c cycle.

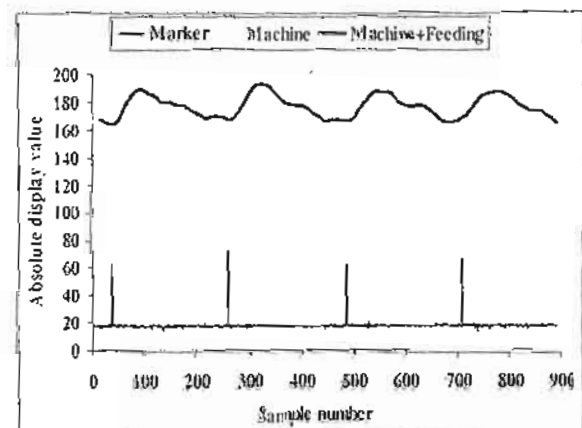

Fig. 9 The output signal at two different cases From the following figure, we note that the mean values of the machine signals have the same values of the lowest feeding force, so we will consider the lowest feeding force is the mean values of the machine signals.



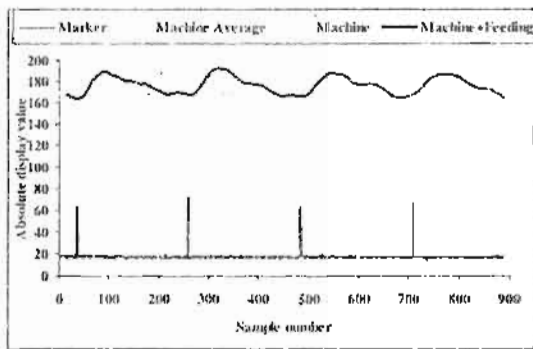

Fig. 10 The output signal of average of machine

6- Sensitivity of the measuring system:-

To make sure of the sensitivity of the measuring system for measuring some parameters we have done.

1- Measuring the feeding force for two different stitch lengths 1.8, 4.4 mm as shown in figure 11.

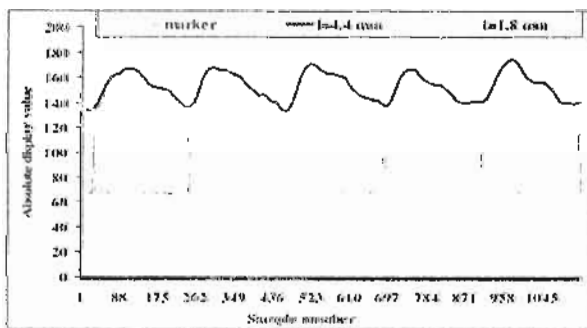

Fig. 11 The output signal for two different stitch length

2- Measuring the feeding force without loading and with loading 4 kg as shown in the following figure.

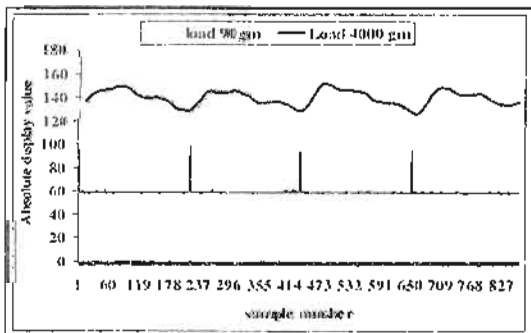

Fig. 12 The output signal for two different load

7- Analysis of out put signal:-

To analyze the output signal we obtain it from the Oscilloscope and save it as excel file which have in the first column the marker signal and the second column is the feeding force. We analyze the data using MATLAB code as shown in figure (13).

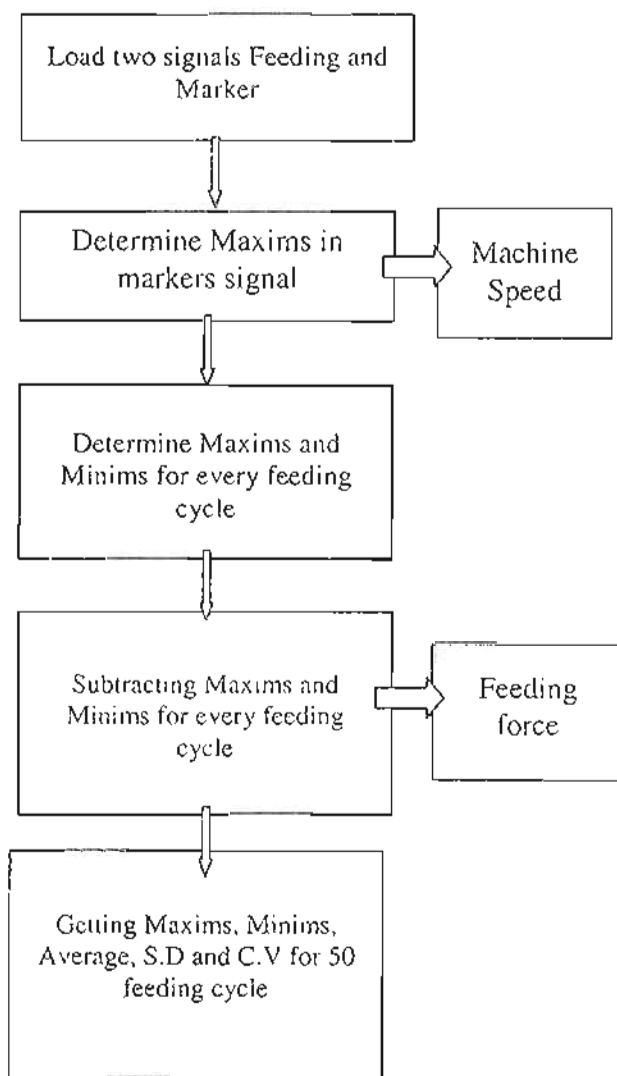

Fig. 13 flow chart for program step

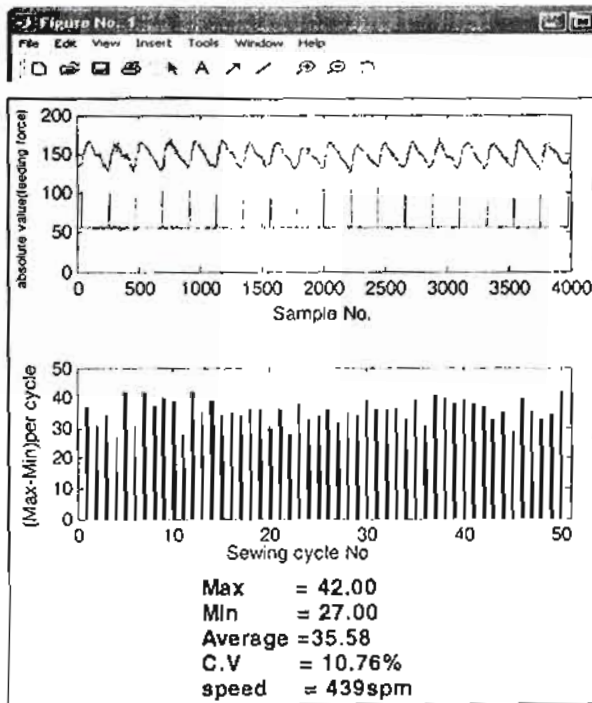

Fig. 14 The output of matlab program

Figure 14 shows the analysis of the signals. The first graph represents the signals that recorded the signal of feeding force and the signal of the optical marker. the second graph represents the estimated feeding force values for 50 successive sewing cycles. The third part shows the estimated values of maximum, minimum, average and coefficient of variation for feeding force and the speed of sewing machine.

**2-8 Experiments planes and Results**

First it was studied the effect of machine parameters as machine speed, load of presser foot and stitch length change on the feeding force and its regularity. Second it was studied the effect of sewing parameters as number of layer and there direction, the angle of sewing on the face and back of fabric on the feeding force. Finally it was studied the effect of

fabric density on the feeding force. Most of this experimental was done on the fabrics had specifications as the following table 1.

Table (2) Fabric specifications

Warp count	: 14 Nm
Weft count	: 10 Nm
Type of fabrics	: 100 % cotton
Fabric density	: 37/cm x 19/cm
Weight / unit area	: 270 g/m <sup>2</sup>
Width	: 140 cm
Fabric structure	: Twill 3/1

**8-1 Effect of sewing machine sitting on the feeding force:-**

**8-1-1 Effect of sewing machine speed**

In order to study the effect of sewing machine speed on the feeling force and its regularity, the signals were recorded at 5 levels from and take the average of 50 readings for each speed at constant load of the pressure foot 4kg and constant of stitch length 4.5mm as shown in table (3).

Table (3) Experimental plane of m/c speed

M/C speed S/min	111	281	439	595	743
Average of feeding	√	√	√	√	√

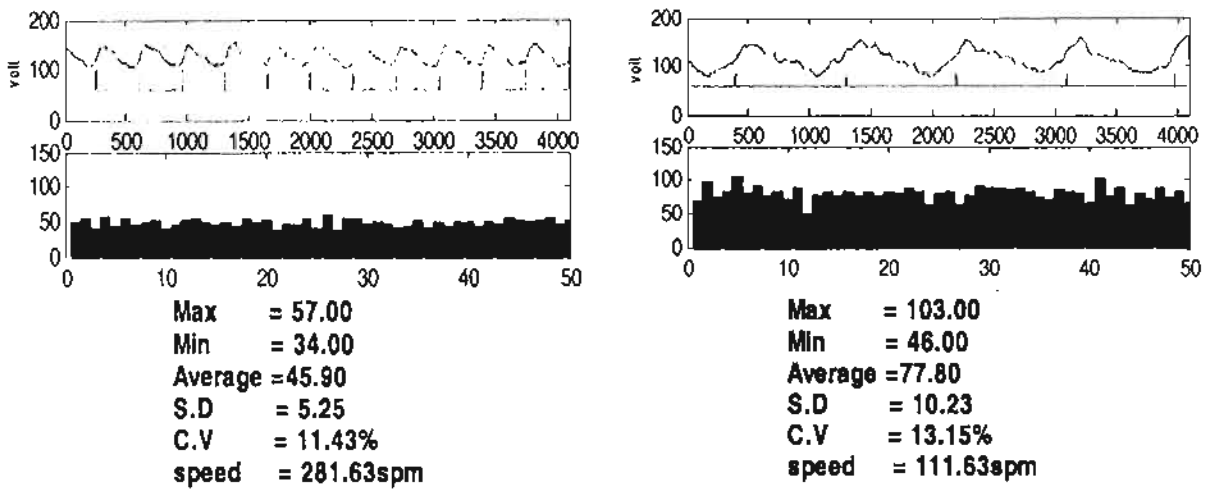

Fig. (15-a) the output of program for effect of speed of machine

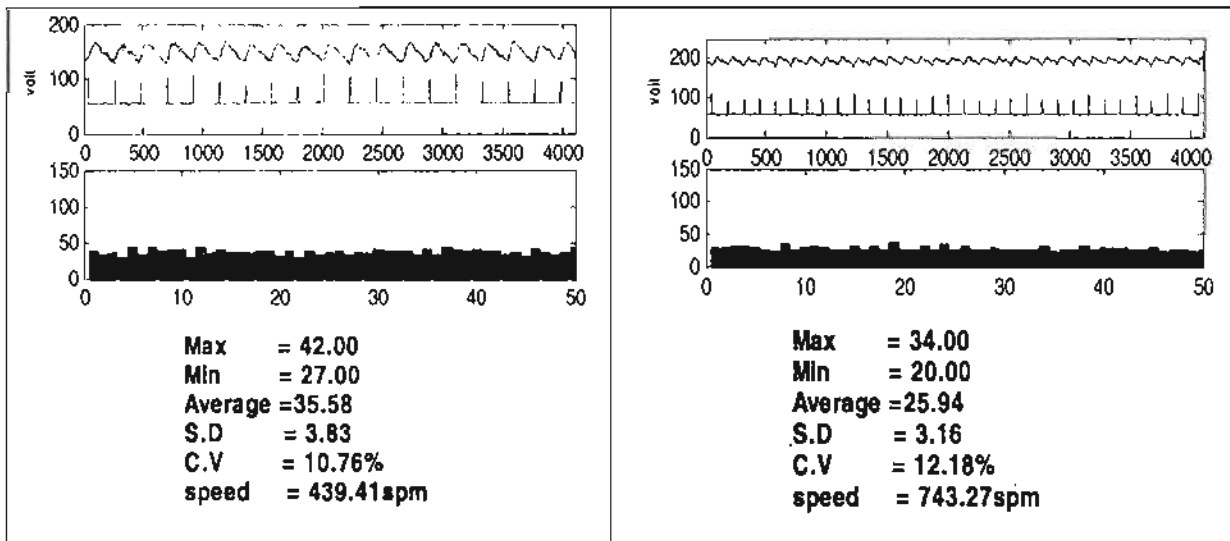

Fig. (15-b) (continue) the output of program for effect of speed of machine

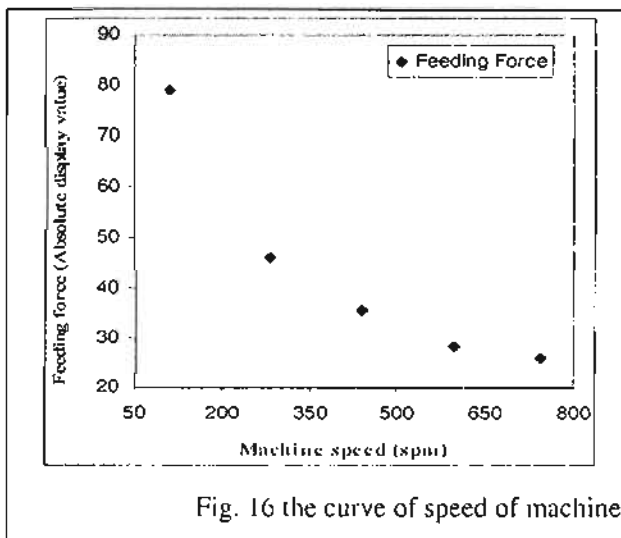

Fig. 16 the curve of speed of machine

Figure 16 shows the estimated values of feeding force on the left y-axis and the coefficient of variation on the right y-axis at different sewing machine speeds (s.p.m). The feeding force decreases with the increase of sewing machine speed. This could be interpreted by the increases of vibration and decreases of the period of time of contact between fabric and presser foot.

### 8-1-2 Effect of stitch density

In order to study the effect of stitch length on the feeding force and its regularity, the signals were recorded at seven different stitch lengths at the max load of presser foot (4 kg) and constant sewing machine speed (442 s.p.m) as shown in table (4). The stitch length value was determined as the average of ten measurements at low speed. Figure 17 shows the analysis of the recorded signals.

Table (4) Experimental plane of stitch density

Stitch density S/cm	2	2.5	3	3.5	4	5	5.5
Average of feeding force	√	√	√	√	√	√	√

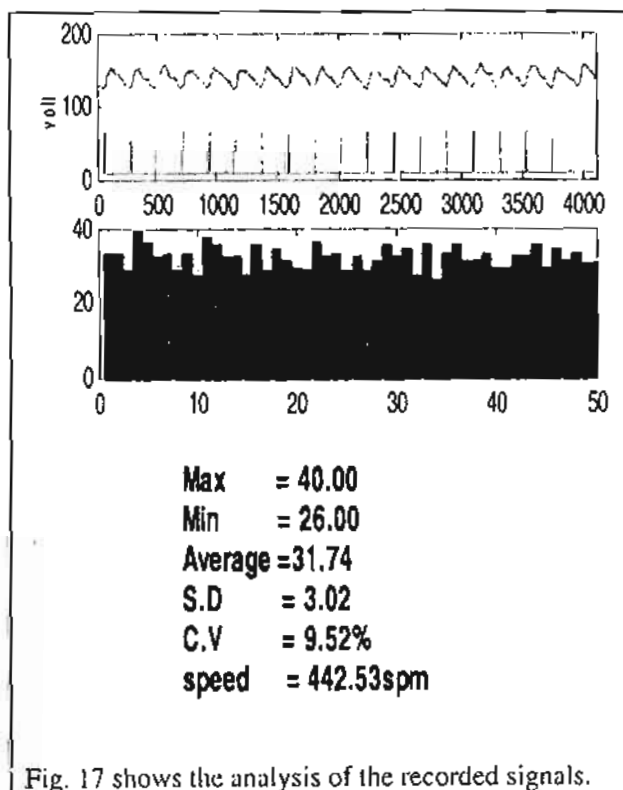

Fig. 17 shows the analysis of the recorded signals.

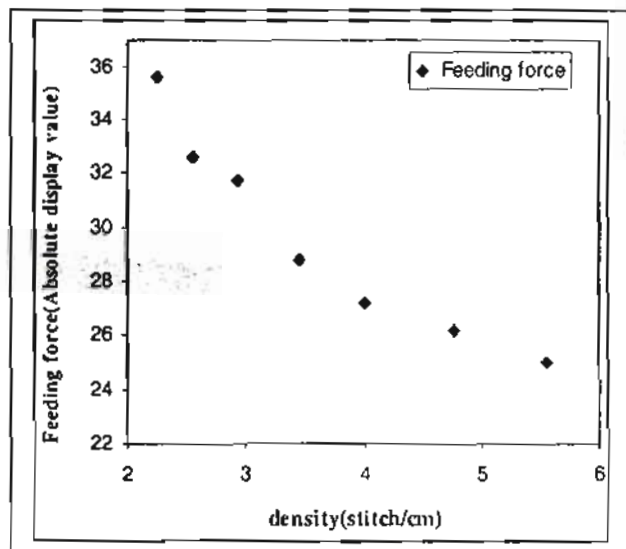

Fig. 18 Effect of stitch density on feeding force.

Figure 18 shows the estimated feeding force on the left y-axis. The increase of feeding force with the increase of stitch length could be interpreted by the increase of work done which equals the multiplication of force and distance where  $W = f * x$

### 8-1-3 Effect of presser foot load

For studying the effect of presser foot load on the feeding force and its regularity, the signals were recorded at different five loads and constant sewing machine speed (442 s.p.m) and constant stitch length (2.1 mm) as shown in table (5). Figure (19) shows the analysis of the recorded signals.

Table (5) Experimental plane of load of presser foot

Load of presser	90	1000	2000	3000	4000
Average of feeding force	√	√	√	√	√

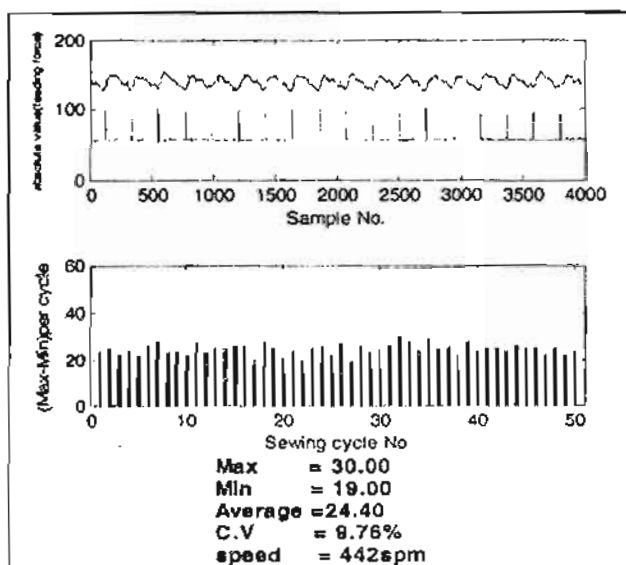

Fig. 19 the analysis of the recorded signals.

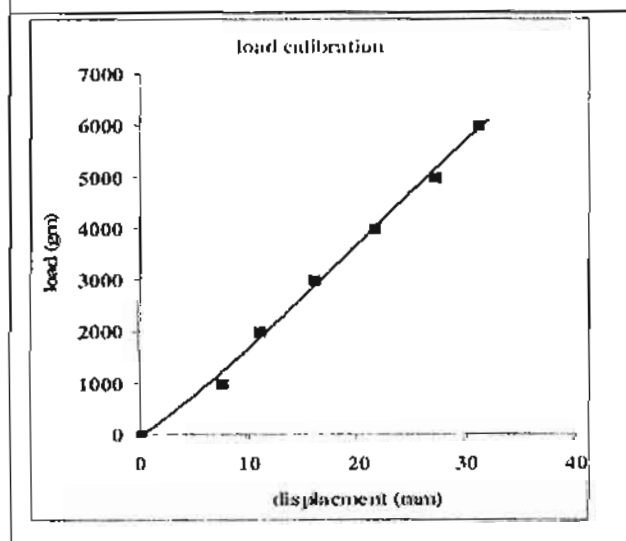

Fig. 20 load calibration curve

### The load calibration curve

As the load of presser bar depends on spring stiffness, calibration was done to get the presser bar constant using known changeable loads. The loads were put on the spring then compression distance after loading was measured. This was repeated until the spring is fully compressed. The relation between displacement and load was plotted as shown in figure 20. Spring constant was 196.9 gm/mm.

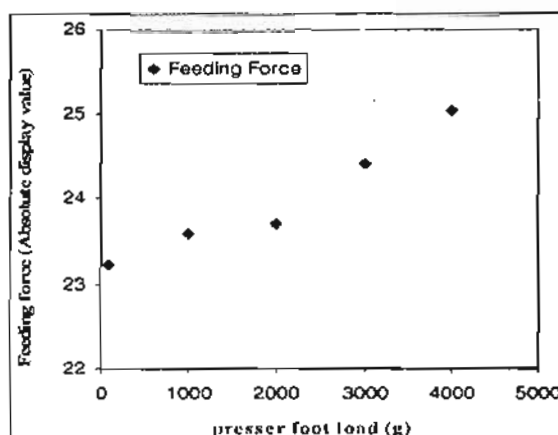

Fig. 21 Effect of load of presser foot on feeding force

As shown in figure (21), when the load increased from 90 gm (the weight of presser foot bar) to 4000 gm, feeding force increased from 23.22 to 25 (absolute display value). This could be interpreted by Amunton law ( $f = \mu N$ ) where the increase in normal pressure leads to increase in friction force.

### 8-2 Effect of sewing parameters:

#### 8-2-1 Effect of number of layer in warp and weft directions

In order to study the effect of no. of layers and fabric direction on feeding force and its regularity, signals were recorded at 5 different no of layers where sewing in warp and weft direction at maximum presser foot loads (4 kg), stitch length of 2.1 mm and machine speed of 442 s.p.m as shown in table (6). Figure (22) and figure 23 shows the analysis of signals that were recorded in warp and weft direction respectively.

Table (6) Experimental plane of number of layer

No of layer	1	2	3	4	5
Average of feeding force	√	√	√	√	√

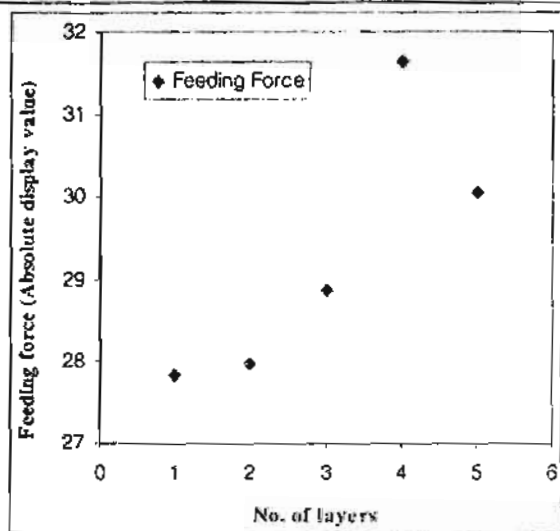
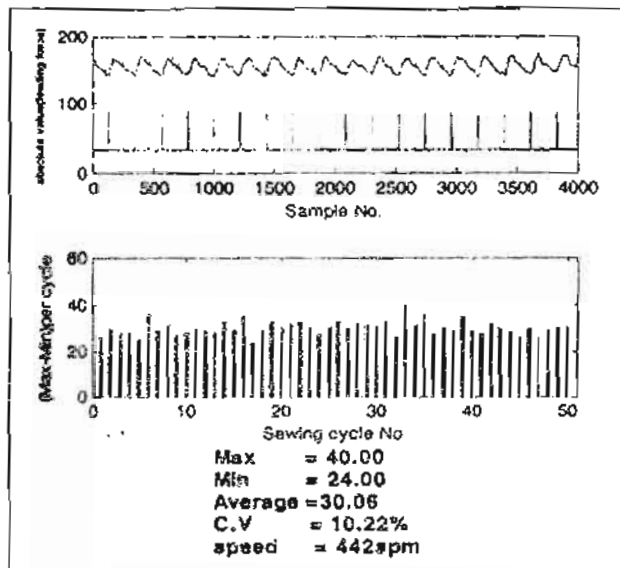

Fig. 22 Warp direction

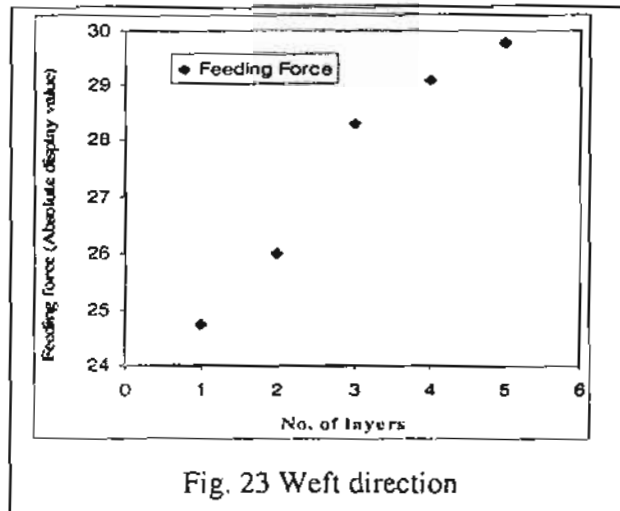
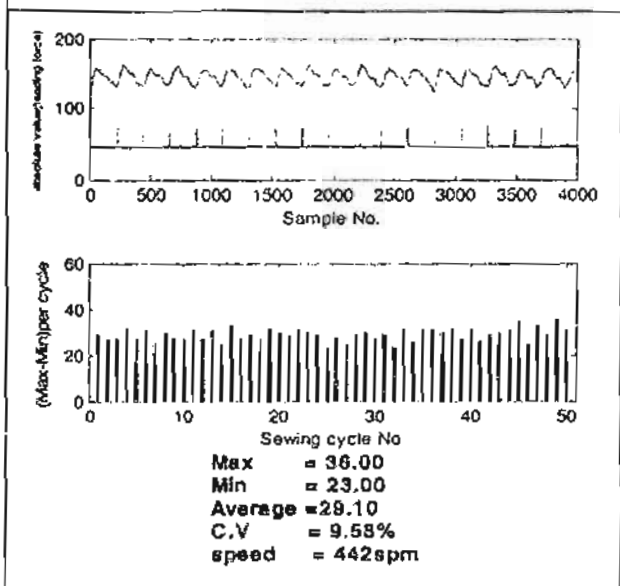

Fig. 23 West direction

8-3 Effect of fabric parameters

Effect of fabric density

In order to study the effect of fabric density, signals were recorded at five grey plain fabrics with different weft density (22, 30, 34, 38, and 45 P.P.I). The signals were recorded at max load (4 kg), stitch length of 2.1 mm and speed of 442 s.p.min as shown in table (8). Fig. 24 shows the analysis of the recorded signals.

Table (8) Experimental plane of fabric density

Fabric density (picks/inch)	22.3	30	34	38	44.7
Average of feeding force	√	√	√	√	√

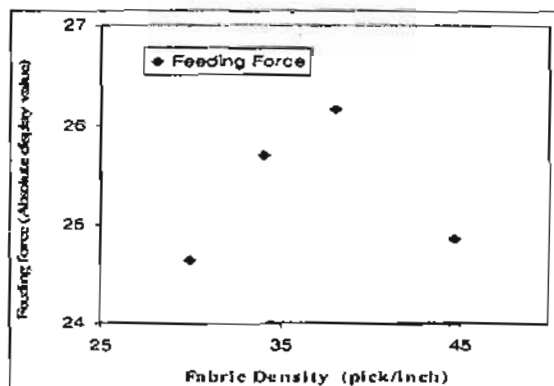

Fig. 24 Effect of fabric density on feeding force

As shown from figure (24), the max feeding force was found at weft density of 38 P.P.I. In general if the tooth pitches of feed dog equals to an integer number of picks. The interlacing could be better and therefore the feeding force is bigger and more regular.

## 10. Conclusion

### Advantage of this system

- 1- This system prove it's succeed in sensitivity for measuring at different sewing machine sitting, sewing parameter and fabric parameter
- 2- Used one head of sewing machine
- 3- Using it as a testing instrument to measure feeding force irregularity

### Disadvantage

- 1- Its Sensitivity appears at stopped of mechanical load as penetration.
- 2- Not measure feeding force directly but measure energy consumption which is equal torque ( $F*L$ ) and couldn't compare force without constant distance.
- 3- Time lag between signal and action because motor efficiency.

Finally By using our new measuring system we could improve the sewing quality instead of correct the sewing defects after their accrued to decrease the product defects (reduce the second quality). By doing this research reach its main gale which is finding the way to predict the regularity stitch length before the production line with comparing the feeding force coefficient of variation by using our computer-based system.

## References

- [1] Zurek, Jankowiak, and Frydrych, "Surface Frictional Resistance of Fabrics Woven from Filament Yarns" Textile Research Institute, February 1985, pp.113-121.
- [2] Hosseini Ravandi S.A., Toriumi K. and Matsumoto Y., "Spectral Analysis of the stick-slip Motion of Dynamic Friction in the Fabric surface", Textile Research Journal 1994, 64(4), pp. 224-229.
- [3] Luis Virto and Arun Naik, "Frictional Behavior of Textile Fabrics - part I: sliding phenomena of Fabrics on Metallic and polymeric solid surfaces", Textile Research Journal. 67(11) 1997, pp. 793-802.
- [4] Luis Virto and Arun Naik, "Frictional Behavior of Textile Fabrics - part II: Dynamic Response for Sliding Friction", Textile Research Journal, 70(3), 2000, pp.256-260.
- [5] Luis F. Silva, Helder carvalho and Filomena Soares "Improving feeding efficiency of a sewing machine by on-line control of the presser foot ", IEEE International Conference on Industrial Technology (ICIT), pp. 990, 2004
- [6] Juciene M. and Vobolis J., " Influence Of Fabric External Friction Force and Certain Parameters of a Sewing Machine Upon Stitch Length ", ISSN 1392-1320, Material science, 10 (1), 2004, pp.101-104.
- [7] Apurba Das, Kothari V.K. and Nagaraju Vandana, "A Study On Frictional Characteristics Of Woven Fabrics", Autex Research journal, 5 (3), September 2005, pp.133-140.
- [8] Vobolis J., Juciene M. ,Punys J. and Vaitkevicius V., " Influence Of Selected Machine and Material Parameters on the Stitch Length and Its Irregularity", Fibres And Textiles In Eastern Europe ,July/September 2003,11 (3) (42), pp. 50-55.
- [9] Abd El-Salam D., "Study the effect of fabric and Sewing Machine Parameters on the Dynamic Behavior of Sewing" MSc. Mansoura University, 2004.